



Item	OE	Photo	Applicable model
EGR001	EG10003-12B1 555019 21159 6NU 010 171-061 7518003 88003 892003 7.24809.00 72480900 724809100 72480910 7.24809.10 724809000 XEGR13 83.647 40 92 1159 06.14.006 V40-63-0007 1603654181		OPEL ASTRA G Box (F70) 09/00 - 04/05 ASTRA G Saloon (F69_) 1.6 16V X16XEL 1598 101 Saloon 4 09/98 - 01/05 ASTRA G Saloon (F69_) 1.6 Z16SE 1598 84 Saloon 4 09/00 - 01/05 ASTRA G Saloon (F69_) 1.8 16V X18XE1 1796 116 Saloon 4 09/98 - 09/00 ASTRA G Saloon (F69_) 1.6 Z16XEP 1598 103 Saloon 4 12/02 - 01/05 OPEL CORSA C (F08, F68) 09/00 - / CORSA C (F08, F68) 1.8 Z18XE 1796 125 Hatchback 4 09/00 - / OPEL MERIVA 05/03 - / MERIVA 1.6 16V Z16XE 1598 100 MPV 4 05/03 - / MERIVA 1.8 Z18XE 1796 125 MPV 4 05/03 - / OPEL TIGRA TwinTop 06/04 - / TIGRA TwinTop 1.8 Z18XE 1796 125 Convertible 06/04 - / OPEL VECTRA B (36_) 10/95 - 04/02 VECTRA B (36_) 1.8 i 16V X18XE 1796 115 Saloon 10/95 - 09/00 VECTRA B (36_) 1.6 i 16V X16XEL 1598 100 Saloon 10/95 - 04/02 OPEL VECTRA B Estate (31_) 11/96 - 07/02 VECTRA B Estate (31_) 1.8 i 16V X18XE 1796 115 Estate 11/96 - 09/00 VECTRA B Estate (31_) 1.6 i 16V X16XEL 1598 100 Estate 11/96 - 07/02 OPEL VECTRA B Hatchback (38_) 10/95 - 07/02 VECTRA B Hatchback (38_) 1.8 i 16V X18XE 1796 116 Hatchback 10/95 - 09/00
EGR002	EG10297-12 B 1 7.22818.58.0 7.22818.01.0 7.22818.03.0 7.22818.26.0 7.22818.49.0 7.22818.45.0 8200004883 8200130609 8200164563 8200247250 8200469586 8200488774A		RENAULT KANGOO (KC0/1_) 01/12 - / RENAULT CLIO II (BB0/1/2_, CB0/1/2_) 04/01 - / RENAULT KANGOO Express (FC0/1_) 01/12 - / RENAULT CLIO II Box (SB0/1/2_) 01/06 - / RENAULT MEGANE II (BM0/1_, CM0/1_) 05/05 - / RENAULT MEGANE II Coupé-Cabriolet (EM0/1_) 05/05 - / RENAULT MEGANE II Saloon (LM0/1_) 05/05 - / RENAULT MEGANE II Estate (KM0/1_) 03/08 - /

Item	OE	Photo	Applicable model
EGR003	EG10298-12B1 4404463 4411697 91124463 93160741 8200088888 7.22818.56.0 7.22818.59.0 7.22818.39.0 7.22818.34.0 7.22818.41.0		OPEL MOVANO Box (F9) 00/09 - / OPEL MOVANO Flatbed / Chassis (U9, E9) 01/10 - / OPEL MOVANO Combi (J9) 01/10 - / OPEL MOVANO Dumptruck (H9) 00/09 - / OPEL VIVARO Box (F7) 03/05 - / OPEL VIVARO Combi (J7) 03/05 - / RENAULT ESPACE III (JE0_) 00/10 - 02/10 RENAULT MASTER II Box (FD) 00/09 - / RENAULT MASTER II Flatbed / Chassis (ED/HD/UD) 00/09 - / RENAULT MASTER II Bus (JD/ND) 00/09 - / RENAULT LAGUNA II (BG0/1_) 01/10 - / RENAULT LAGUNA II Grandtour (KG0/1_) 01/10 - / RENAULT VEL SATIS (BJ0_) 02/06 - / VAUXHALL MOVANO Mk I (A) Van (FD) 00/09 - / VAUXHALL MOVANO Mk I (A) Combi (JD) 01/10 - / VAUXHALL MOVANO Mk I (A) Chassis/Cab (ED, UD, HD) 00/09 - / VAUXHALL VIVARO Combi 04/04 - /
EGR004	EG10296-12B1 4411757 4412632 7700107797 8200231630 8200360200 8200231630 7.22818.57.0 7.22818.02.0		OPEL MOVANO Box (F9) 00/09 - 01/10 OPEL MOVANO Combi (J9) 00/09 - 01/10 OPEL VIVARO Box (F7) 01/08 - / OPEL VIVARO Combi (J7) 01/08 - / RENAULT MEGANE I (BA0/1_) 01/02 - / RENAULT MEGANE I Coach (DA0/1_) 01/02 - 03/08 RENAULT MEGANE I Classic (LA0/1_) 01/02 - / RENAULT MEGANE I Grandtour (KA0/1_) 01/02 - / RENAULT SCÉNIC I (JA0/1_) 99/09 - 03/08 RENAULT TRAFIC II Bus (JL) 01/03 - / RENAULT TRAFIC II Box (FL) 01/03 - / RENAULT MEGANE II (BM0/1_, CM0/1_) 02/11 - / RENAULT MEGANE II Coupé-Cabriolet (EM0/1_) 03/09 - / RENAULT MEGANE II Saloon (LM0/1_) 03/09 - / RENAULT MEGANE II Estate (KM0/1_) 05/05 - /

Item	OE	Photo	Applicable model
EGR005	BG10006-12 1B 17098361 5851025 5851603 93184996 581025 7.24809.12.0 7.24809.02.0 14904		OPEL VECTRA B Hatchback (38_) 95/10 - 02/07 OPEL VECTRA B (36_) 95/10 - 02/04 OPEL VECTRA B Estate (31_) 96/11 - 02/07 OPEL ASTRA G Hatchback (F48_, F08_) 98/02 - 05/01 OPEL ASTRA G Estate (F35_) 98/02 - 04/07 OPEL ASTRA G Saloon (F69_) 98/09 - 05/01 OPEL ZAFIRA (F75_) 99/04 - 05/06 VAUXHALL VECTRA (B) 95/10 - / VAUXHALL VECTRA (B) Hatchback 95/10 - / VAUXHALL VECTRA (B) Estate 96/11 - / VAUXHALL ASTRA Mk IV (G) Hatchback 98/02 - / VAUXHALL ASTRA Mk IV (G) 98/09 - / VAUXHALL ASTRA Mk IV (G) Estate 98/02 - / VAUXHALL ZAFIRA Mk I (A) 99/04 - /
EGR006	17095232 17094050 5851005 5851602 851581 93184995 7.24809 11 0 7.24809.01.0 14901		OPEL ASTRA F Hatchback (53_, 54_, 58_, 59_) 96/01 - 98/01 OPEL VECTRA B Hatchback (38_) 95/10 - 03/07 OPEL VECTRA B Estate (31_)/(36_) 96/02 - 98/01 OPEL ASTRA F Estate (51_, 52_) 96/02 - 98/01 OPEL TIGRA (95_) 94/07 - 00/12 OPEL ASTRA F Van (55_) 93/02 - 96/07 OPEL CORSA B Box (73_) 99/08 - 00/09 OPEL ASTRA F CLASSIC Saloon 98/01 - 02/08 OPEL ASTRA F CLASSIC Hatchback 98/01 - 02/08 OPEL ASTRA F CLASSIC Estate 98/01 - 05/01 VAUXHALL ASTRA Mk III (F) Hatchback 94/01 - 98/02 VAUXHALL ASTRA Mk III (F) Estate 94/01 - 98/02 VAUXHALL CAVALIER Mk III (87) 93/09 - 95/11 VAUXHALL CORSA Mk II (B) 93/03 - 00/09 VAUXHALL TIGRA Mk I 94/07 - 00/12 VAUXHALL CAVALIER Mk III Hatchback 93/09 - 95/11 VAUXHALL VECTRA (B) Hatchback 95/10 - 00/12 VAUXHALL VECTRA (B) Estate 96/11 - / VAUXHALL ASTRA Mk III (F) 92/03 - 98/09 VAUXHALL CORSA Convertible 98/01 - /

Item	OE	Photo	Applicable model
EGR007	EG10007-12 B 1 7.24809.13.0 5851009 17096243 14907		OPEL VECTRA B Hatchback (38_) 95/10 - 00/09 OPEL VECTRA B (36_) 95/10 - 00/09 OPEL VECTRA B Estate (31_) 98/05 - 00/09 VAUXHALL VECTRA (B) 95/09 - 00/08 VAUXHALL VECTRA (B) Hatchback 95/09 - 00/08 VAUXHALL VECTRA (B) Estate 96/11 - 00/08
EGR008	EG10015-12 B1 851578 17094107 5851576 5851608 7.24809.14.0 14906		OPEL OMEGA B Estate (21_, 22_, 23_) 94/03 - 00/09 OPEL SINTRA 96/11 - 99/04 OPEL OMEGA B (25_, 26_, 27_) 99/09 - 03/07 VAUXHALL OMEGA (B) 01/02 - 04/03 VAUXHALL OMEGA (B) Estate 94/03 - 00/09 VAUXHALL SINTRA 96/11 - 99/04
EGR009	EG10323-12B1 8200360201 8200282879 8200157971 8200293950 8200467030 8200542998 7.22818.61.0 7.22818.36.0 7.22818.53.0 7.22818.62.0		RENAULT MEGANE II (BM0/1_, CM0/1_) 02/11 - / RENAULT MEGANE II Coupé-Cabriolet (EM0/1_) 03/09 - / RENAULT MEGANE II Saloon (LM0/1_) 03/09 - / RENAULT MEGANE II Estate (KM0/1_) 03/08 - /
EGR010	9628355780 1628.JF 9628355780 EG10256-12B1		FIAT ULYSSE (220) 98/05 - 00/09 FIAT ULYSSE (179AX) 02/08 - / PEUGEOT 406 (8B) 99/01 - 00/08 PEUGEOT 406 Break (8E/F) 00/10 - 04/10 PEUGEOT 406 Coupe (8C) 99/01 - 00/10 PEUGEOT 206 Hatchback (2A/C) 99/04 - 00/10 PEUGEOT 407 (6D_) 04/05 - / PEUGEOT 407 SW (6E_) 04/05 - /
EGR011	46785766 55182482 55204235 55215029 60816439 851757		FIAT ULYSSE (220) 98/05 - 00/09 FIAT ULYSSE (179AX) 02/08 - / PEUGEOT 406 (8B) 99/01 - 00/08 PEUGEOT 406 Break (8E/F) 00/10 - 04/10 PEUGEOT 406 Coupe (8C) 99/01 - 00/10 PEUGEOT 206 Hatchback (2A/C) 99/04 - 00/10 PEUGEOT 407 (6D_) 04/05 - / PEUGEOT 407 SW (6E_) 04/05 - /

Item	OE	Photo	Applicable model
EGR012	55186214 55194734 55205455 55215032 5851596 851342 5851596 5851827 93178886 851342		ALFA ROMEO 159 05/09 - / ALFA ROMEO 159 Sportwagon 06/03 - / FIAT PUNTO / GRANDE PUNTO (199) 05/10 - / FIAT SEDICI 06/06 - / OPEL VECTRA C 04/04 - / OPEL VECTRA C GTS 04/04 - / OPEL SIGNUM 04/04 - / OPEL VECTRA C Estate 04/04 - / OPEL ASTRA H 05/09 - / OPEL ASTRA H Estate 05/09 - / OPEL ASTRA H GTC 05/03 - / OPEL ZAFIRA 05/07 - / OPEL ASTRA H TwinTop 05/09 - / VAUXHALL ASTRA Mk V (H) Hatchback 05/08 - / VAUXHALL ASTRA Mk V (H) Estate 05/09 - /
EGR013	46823850 55194735 55204250 55215031 93181981 5851067 851341		ALFA ROMEO 156 (932) 02/11 - 05/09 ALFA ROMEO 166 (936) 03/10 - / ALFA ROMEO 156 Sportwagon (932) 02/11 - 06/05 ALFA ROMEO 147 (937) 05/07 - / ALFA ROMEO GT 03/11 - / ALFA ROMEO 159 05/09 - / ALFA ROMEO BRERA 06/01 - / ALFA ROMEO 159 Sportwagon 07/05 - / ALFA ROMEO SPIDER (939) 08/03 - / FIAT STILO (192) 04/01 - / FIAT STILO Multi Wagon (192) 04/01 - / FIAT CROMA (194) 05/06 - / LANCIA THESIS (841AX) 03/05 - / OPEL VECTRA C 04/04 - / OPEL VECTRA C GTS 04/04 - / OPEL SIGNUM 04/04 - / OPEL VECTRA C Estate 04/04 - / OPEL ASTRA H 04/09 - / OPEL ASTRA H Estate 04/08 - / OPEL ASTRA H GTC 05/03 - / OPEL ZAFIRA 05/07 - / OPEL ASTRA H TwinTop 05/09 - / SAAB 9-5 (YS3E) 06/01 - / SAAB 9-5 Estate (YS3E) 06/01 - / SAAB 9-3 (YS3F) 04/09 - / SAAB 9-3 Convertible (YS3F) 06/01 - / VAUXHALL VECTRA Mk II (C) 04/04 - 05/08 VAUXHALL VECTRA Mk II (C) GTS 04/04 - 05/08 VAUXHALL SIGNUM 04/04 - 05/08 VAUXHALL ASTRA Mk V (H) Hatchback 04/06 - /
EGR014	EGR1103 17099322 17113527 17113589 17113614 17200257		CHEVROLET CAMARO SS 1998-2002 CHEVROLET CAMARO Z28 1998-2002 PONTIAC FIREBIRD FIREHAWK 1998 PONTIAC FIREBIRD FORMULA 1998-2002 PONTIAC FIREBIRD TRANS AM 1998- 2002

Item	OE	Photo	Applicable model
EGR015	EGV543 17096306 8-17096-306-0 17096100		Buick Century Sedan / Coupe (96) Buick Skylark (98-96) Chevrolet Beretta (96) Chevrolet Cavalier (98-96) Chevrolet Corsica (96) Chevrolet Malibu / Malibu Maxx (99-97) Chevrolet S10 Pickup (98-96) GMC S15 Pickup (98-96) Isuzu Hombre (00-96) Oldsmobile Achieva (98-96) Oldsmobile Ciera / Cutlass Ciera (96) Pontiac Grand Am (99-96) Pontiac Sunfire (98-96)
EGR016	EGV589 12568582 12576918 17093020 17096188 17096309 17112996 17113278 17113303 17113619 17200271		Acura SLX (96) Buick Lacrosse (05) Buick Lesabre Sedan / Coupe (05-02) Cadillac Deville (05-00) Cadillac Eldorado (02-00) Chevrolet Astro (02-93) Chevrolet Suburban / Fullsize Blazer / Tahoe (02-96) GMC Fullsize Pickup (02-93) Honda Passport (02-96) Isuzu Amigo (00-98) Isuzu Axiom (04-02) Isuzu Vehicross (01-99) Oldsmobile Aurora (03-01) Oldsmobile Bravada (01-96) Pontiac Bonneville (05-02) Pontiac Grand Prix (05-02) Buick Century Sedan / Coupe (99-96)
EGR017	EGV468 17096154 17113285		Buick Century Sedan / Coupe (99-96) Buick Regal Sedan / Coupe (96) Buick Skylark (98-96) Chevrolet Beretta (96) Chevrolet Corsica (96) Chevrolet Venture (99-97) Oldsmobile Achieva (98-96) Oldsmobile Alero (99) Oldsmobile Ciera / Cutlass Ciera (96) Pontiac Grand Am (99-96) Pontiac Trans Sport (98-96) Saturn L Series (03-02) Saturn I.W. Series (03-00)
EGR018	EGV513 17113535 12578038 17113613 EG10021 17094028		Chevrolet Fullsize Pickup (00-95) Chevrolet G Series Fullsize Van / Express (00-95) Chevrolet P Series Van (99-95) Chevrolet Suburban / Fullsize Blazer / Tahoe (99-95) GMC Fullsize Pickup (00-95) GMC G Series Fullsize Van / Savana (00-95) GMC P Series Van (99-95) GMC Suburban / Fullsize Jimmy / Yukon (99-95) Isuzu Hombre (97)

Item	OE	Photo	Applicable model
EGR019	EGV514 12578042 17094153 17094185 17113283		Buick Lesabre Sedan / Coupe (95-94) Buick Park Avenue (95-94) Buick Regal Sedan / Coupe (95-94) Buick Riviera (95) Chevrolet Lumina APV (95-94) Oldsmobile 98 / 98 Regency (95-94) Oldsmobile Delta 88 (95-94) Oldsmobile LSS (99-96) Oldsmobile Silhouette (95-94) Pontiac Bonneville (95-94) Pontiac Trans Sport (95-94)
EGR020	EGV589 12568582 12576918 17093020 17096188 17096309 17112996 17113278 17113303 17113619 17200271		Buick, Cadillac, Chevy, GMC, Oldsmobile, Pontiac, Each
EGR021	55184651 55184651 55219498 55201144 55219498 55184651 55201144 93177422 58 51 049 93196798 8 51 364 8 51 744 93189335 8 51 364 93177422 93189335 58 51 049 93196798 8 51 744		FIAT DOBLO Cargo (223) 10/03 - / DOBLO Cargo (223) 1.3 JTD 16V 188A9.000 1248 70 Box 05/04 - / DOBLO Cargo (223) 1.3 D Multijet 1248 75 Box 4 10/05 - / FIAT PANDA (169) 10/04 - / PANDA (169) 1.3 JTD 188A9.000 1248 70 Hatchback 09/03 - / PANDA (169) 1.3 JTD 4x4 188A9.000 1248 70 Hatchback 10/04 - / FIAT IDEA 01/04 - / IDEA 1.3 JTD 188A9.000 1248 70 MPV 4 01/04 - / OPEL MERIVA 09/03 - / MERIVA 1.3 CDTI Z13DTJ 1248 75 MPV 4 09/03 - / SUZUKI IGNIS II 09/03 - / IGNIS II 1.3 DDiS Z13DT 1248 70 Closed Off -Road Vehicle 09/03 - / SUZUKI WAGON R+ (MM) 09/03 - / WAGON R+ (MM) 1.3 DDiS 1248 70 MPV 09/03 - / VAUXHALL CORSA Mk II 04/04 - / CORSA Mk II 1.3 CDTI 16V 1248 70 Hatchback 04/04 - / VAUXHALL CORSAVAN MK II 04/04 - /

Item	OE	Photo	Applicable model
EGR022	55192348 55195196 55204941 55219499 55204941 5851060 5851065 93184196 93188772 93196799 851368 93196799		FIAT DOBLO Cargo (223) 10/05 - / DOBLO Cargo (223) 1.3 JTD 16V 188A9.000 1248 70 Box 05/04 - / DOBLO Cargo (223) 1.3 D Multijet 1248 75 Box 4 10/05 - / LANCIA MUSA 10/04 - / MUSA 1.3 Multijet 188 A9.000 1248 70 MPV 10/04 - / LANCIA YPSILON 09/06 - / YPSILON 1.3 JTD 1248 70 Hatchback 10/03 - / YPSILON 1.3 Multijet 199 A3.000 1248 90 Hatchback 4 09/06 - / YPSILON 1.3 Multijet 199 A2.000 1248 75 Hatchback 4 09/06 - / FIAT GRANDE PUNTO (199) 10/05 - / GRANDE PUNTO (199) 1.3 D Multijet 199 A2.000 1248 75 Hatchback 4 10/05 - / GRANDE PUNTO (199) 1.3 D Multijet 199 A3.000 1248 90 Hatchback 4 10/05 - / FIAT IDEA 01/04 - / IDEA 1.3 JTD 188A9.000 1248 70 MPV 4 01/04 - / OPEL ASTRA H 08/05 - / ASTRA H 1.3 CDTI Z13DTH 1248 90 Hatchback 4 08/05 - / OPEL ASTRA H GTC 04/05 - / ASTRA H GTC 1.3 CDTI 1248 90 Hatchback 4 04/05 - / OPEL ASTRA H Estate 08/05 - / ASTRA H Estate 1.3 CDTI Z13DTH 1248 90 Estate 4 08/05 - / VAUXHALL ASTRA MK V Hatchback 10/05 - /
EGR023 with hole	EG10288-12B1 5851029 90117397 90470477 90570478 9117397 7.22414.05.0 7.22414.01.0 7.22515.01.0 7.22414.51.0 14922	<b>WITH HOLE</b> 	OPEL CORSA B (73_, 78_, 79_, F35_) 03/98 - 09/00 CORSA B (73_, 78_, 79_, F35_) 1.2 i 16V X12XE 1199 65 Hatchback 03/98 - 09/00 VAUXHALL CORSA 03/98 - 09/00 CORSA 1.2 i 16V X12XE 1199 65 Hatchback 03/98 - 09/00
EGR024 without hole	EG10287-12B1 5851020 851706 851708 90543031 90570475 90570476 722414040 722414500 722141000 722515000 14928	<b>WITH OUT HOLE</b> 	OPEL CORSA B (73_, 78_, 79_, F35_) 11/96 - 09/00 CORSA B (73_, 78_, 79_, F35_) 1.0 i 12V X10XE 973 54 Hatchback 11/96 - 09/00 VAUXHALL CORSA 11/96 - 09/00 CORSA 1.0 i 12V X10XE 973 54 Hatchback 11/96 - 09/00







Item	OE	Photo	Applicable model
EGR025	5851041 5851594 9196675 93176989 4774311 93176989 9196675 7375D		CHEVROLET ASTRA Hatchback 08/02 - 00/00 ASTRA Hatchback 2.0 DTi Y20DTH 1995 101 Hatchback 4 08/02 - 00/00 CHEVROLET ASTRA Saloon 08/02 - / ASTRA Saloon 2.0 DTi GLS Y20DTH 1995 101 Saloon 4 08/02 - / OPEL ASTRA G Convertible 09/02 - 10/05 ASTRA G Convertible 2.2 DTi Y22DTR 2172 125 Convertible 09/02 - 10/05 OPEL ASTRA G Coupe (F07_) 09/02 - 05/05 ASTRA G Coupe (F07_) 2.2 DTi Y22DTR 2172 125 Coupe 09/02 - 05/05 OPEL ASTRA G Estate (F35_) 09/02 - 07/04 ASTRA G Estate (F35_) 2.0 DTi 16V X20DTH 1995 101 Estate 08/99 - 07/04 ASTRA G Estate (F35_) 2.2 DTi Y22DTR 2172 125 Estate 09/02 - 07/04 OPEL ASTRA G Hatchback (F48_, F08_) 09/02 - 01/05 ASTRA G Hatchback (F48_, F08_) 2.0 DTi 16V X20DTH 1995 101 Hatchback 08/99 - 01/05 ASTRA G Hatchback (F48_, F08_) 2.2 DTi Y22DTR 2172 125 Hatchback 09/02 - 01/05 OPEL ASTRA G Saloon (F69_) 09/02 - 01/05 ASTRA G Saloon (F69_) 2.0 DTi 16V X20DTH 1995 101 Saloon 4 08/99 - 01/05 ASTRA G Saloon (F69_) 2.2 DTi Y22DTR 2172 125 Saloon 4 09/02 - 01/05 OPEL FRONTERA B (6B_) 10/98 - 09/02 FRONTERA B (6B_) 2.2 DTi (6B_ZC, 6B_VF, 6B_66, 6B_76) X22DTH 2171 116 OPEL ASTRA G Saloon (F69_) 09/00 - 01/05 ASTRA G Saloon (F69_) 1.2 16V Z12XE 1199 75 Saloon 4 09/00 - 01/05 OPEL ASTRA G Hatchback (F48_, F08_) 09/00 - 01/05 ASTRA G Hatchback (F48_, F08_) 1.2 16V Z12XE 1199 75 Hatchback 09/00 - 01/05 OPEL ASTRA G Estate (F35_) 09/00 - 07/04 ASTRA G Estate (F35_) 1.2 16V Z12XE 1199 75 Estate 09/00 - 07/04 OPEL AGILA (H00) 09/00 - / AGILA (H00) 1.0 Z10XEP 998 60 Estate 08/03 - / AGILA (H00) 1.0 12V Z10XE 973 58 Estate 09/00 - / AGILA (H00) 1.2 16V Z12XE 1199 75 Estate 09/00 - / OPEL ASTRA H 03/04 - / ASTRA H 1.4 Z14XEP 1364 90 Hatchback 4 03/04 - / OPEL ASTRA H GTC 03/05 - / ASTRA H GTC 1.4 Z14XEP 1364 90 Hatchback 4 03/05 - / OPEL ASTRA H Estate 08/04 - / ASTRA H Estate 1.4 Z14XEP 1364 90 Estate 4 08/04 - / OPEL CORSA C (F08, F68) 09/00 - / CORSA C (F08, F68) 1.0 Z10XE 973 58 Hatchback 3 09/00 - / CORSA C (F08, F68) 1.2 Z12XE 1199 75 Hatchback 4 09/00 - / OPEL CORSA C Box (F08, W5L) 09/00 - / CORSA C Box (F08, W5L) 1.2 16V Z12XE
EGR026	7.22875.13.0 5851607 851593 9157671 93185000 851593 09157671		OPEL ASTRA G Saloon (F69_) 09/00 - 01/05 ASTRA G Saloon (F69_) 1.2 16V Z12XE 1199 75 Saloon 4 09/00 - 01/05 OPEL ASTRA G Hatchback (F48_, F08_) 09/00 - 01/05 ASTRA G Hatchback (F48_, F08_) 1.2 16V Z12XE 1199 75 Hatchback 09/00 - 01/05 OPEL ASTRA G Estate (F35_) 09/00 - 07/04 ASTRA G Estate (F35_) 1.2 16V Z12XE 1199 75 Estate 09/00 - 07/04 OPEL AGILA (H00) 09/00 - / AGILA (H00) 1.0 Z10XEP 998 60 Estate 08/03 - / AGILA (H00) 1.0 12V Z10XE 973 58 Estate 09/00 - / AGILA (H00) 1.2 16V Z12XE 1199 75 Estate 09/00 - / OPEL ASTRA H 03/04 - / ASTRA H 1.4 Z14XEP 1364 90 Hatchback 4 03/04 - / OPEL ASTRA H GTC 03/05 - / ASTRA H GTC 1.4 Z14XEP 1364 90 Hatchback 4 03/05 - / OPEL ASTRA H Estate 08/04 - / ASTRA H Estate 1.4 Z14XEP 1364 90 Estate 4 08/04 - / OPEL CORSA C (F08, F68) 09/00 - / CORSA C (F08, F68) 1.0 Z10XE 973 58 Hatchback 3 09/00 - / CORSA C (F08, F68) 1.2 Z12XE 1199 75 Hatchback 4 09/00 - / OPEL CORSA C Box (F08, W5L) 09/00 - / CORSA C Box (F08, W5L) 1.2 16V Z12XE

Item	OE	Photo	Applicable model
EGR027	12578039 17113614 2141041 EGR1152		CHEVROLET 2000-2001 PONTIAC 2000-
EGR028	17093135 17113280 12578035		CHEVROLET CORVETTE ZR-1 1993-1995
EGR029	21015284 EG10176 EGV618		SATURN SC SERIES 2000-2002 SATURN SL SERIES 2000-2002 SATURN SW SERIES 2000-2001
EGR030	22701853 EGV814		SATURN L SERIES 3.0L 2003- SATURN LW SERIES 3.0L 2003

Item	OE	Photo	Applicable model
EGR031	EG10293-12B1 03D131503B 7.22785.16.0 7.22785.12.0		SEAT CORDOBA (6L2) 10/02 - / CORDOBA (6L2) 1.2 AZQ 1198 64 Saloon 10/02 - / SEAT IBIZA IV (6L1) 02/02 - / IBIZA IV (6L1) 1.2 AZQ 1198 64 Hatchback 02/02 - / SKODA FABIA (6Y2) 01/03 - / FABIA (6Y2) 1.2 AZQ 6Y2 1198 64 Hatchback 3 01/03 - / SKODA FABIA Combi (6Y5) 01/03 - / FABIA Combi (6Y5) 1.2 AZQ 1198 64 Estate 01/03 - / SKODA FABIA Praktik 01/03 - / FABIA Praktik 1.2 AZQ 1198 64 Box 3 01/03 - / SKODA FABIA Saloon (6Y3) 01/03 - / FABIA Saloon (6Y3) 1.2 AZQ 6Y3 1198 64 Saloon 3 01/03 - / VOLKSWAGEN POLO (9N_) 10/01 - / POLO (9N_) 1.2 AZQ 1198 64 Hatchback 10/01 - /
EGR032	EG10290-12B1 06A131501F 7.22574.11.0 7.22574.12.0		AUDI A3 (8L1) 08/00 - / A3 (8L1) 1.6 APF 8L1 1595 101 Hatchback 4 09/96 - 08/00 A3 (8L1) 1.6 BFG 8L1 1595 102 Hatchback 4 08/00 - / SEAT ALHAMBRA (7V8, 7V9) 04/96 - / ALHAMBRA (7V8, 7V9) 2.0 i ADY 7V8, 7V9 1984 115 MPV 04/96 - / SEAT CORDOBA Hatchback (6K2) 06/99 - 10/02 CORDOBA Hatchback (6K2) 1.6 APF 1595 101 Hatchback 06/99 - 10/02 SEAT CORDOBA Vario (6K5) 06/99 - / CORDOBA Vario (6K5) 1.6 AEH 1595 101 Estate 4 06/99 - / SEAT IBIZA III (6K1) 08/99 - 02/02 IBIZA III (6K1) 1.6 APF 1595 101 Hatchback 08/99 - 02/02 SKODA OCTAVIA (1U2) 11/00 - / OCTAVIA (1U2) 1.6 AVU 1595 102 Hatchback 11/00 - / SKODA OCTAVIA Combi (1U5) 09/00 - / OCTAVIA Combi (1U5) 1.6 AVU 1595 102 Estate 09/00 - / VOLKSWAGEN BORA (1J2) 08/00 - 05/05 BORA (1J2) 1.6 AEH 1595 101 Saloon 10/98 - 05/05 BORA (1J2) 1.6 AVU 1595 102 Saloon 08/00 - 05/05 VOLKSWAGEN BORA Estate (1J6) 05/99 - 05/05 BORA Estate (1J6) 1.6 AVU 1595 102 Estate 08/00 - 05/05 BORA Estate (1J6) 1.6 AEH 1J6 1595 100

Item	OE	Photo	Applicable model
EGR033	EG10309-12 B1 036131503T 7.28248.17.0 7.28248.16.0		DI A2 (8Z0) 02/00 - 08/05 A2 (8Z0) 1.4 BBY 8Z0 1390 75 Hatchback 4 02/00 - 08/05 SEAT AROSA (6H) 01/00 - 06/04 AROSA (6H)1.4 16V AFK 1390 100 Hatchback 4 01/00 - 06/04 SEAT CORDOBA (6L2) 10/02 - / CORDOBA (6L2) 1.4 16V BBZ 1390 100 Saloon 10/02 - / SEAT CORDOBA Hatchback (6K2) 05/00 - 10/02 CORDOBA Hatchback (6K2) 1.4 16V AQQ 1390 100 Hatchback 02/00 - 10/02 CORDOBA Hatchback (6K2) 1.4 16V APE 1390 75 Hatchback 05/00 - 10/02 SEAT CORDOBA Vario (6K5) 06/99 - / CORDOBA Vario (6K5) 1.4 16V 1390 75 Estate 06/99 - / SEAT IBIZA III (6K1) 05/00 - 02/02 IBIZA III (6K1) 1.4 16V AQQ 1390 100 Hatchback 08/99 - 02/02 IBIZA III (6K1) 1.4 16V APE 1390 75 Hatchback 05/00 - 02/02 SEAT IBIZA IV (6L1) 02/02 - / IBIZA IV (6L1) 1.4 16V AUB 1390 100 Hatchback 02/02 - / IBIZA IV (6L1) 1.4 16V BBY 1390 75 Hatchback 4 02/02 - / SEAT INCA (6K9) 04/00 - / INCA (6K9) 1.4 16V AUA 1390 75 Box 04/00 - / SEAT LEON (1M1) 09/00 - / LEON (1M1) 1.6 16 V AUS 1598 105 Hatchback 09/00 - /
EGR034	EG 10295-12 B1 06A131501G 7.22785.14.0 7.22785.18.0		AUDI A3 (8L1) 09/96 - / A3 (8L1) 1.8 APG 8L1 1781 125 Hatchback 4 09/96 - / SEAT LEON (1M1) 11/99 - / LEON (1M1) 1.8 20V AGN 1781 125 Hatchback 11/99 - / SEAT TOLEDO II (1M2) 04/99 - 05/06 TOLEDO II (1M2) 1.8 20V AGN 1781 125 Saloon 04/99 - 05/06



Item	OE	Photo	Applicable model
EGR035	EG10294-12B1 036131503M 7.22785.17.0 7.22785.13.0		AUDI A2 (8Z0) 02/00 - 08/05 A2 (8Z0) 1.4 BBY 8Z0 1390 75 Hatchback 4 02/00 - 08/05 SEAT AROSA (6H) 01/00 - 06/04 AROSA (6H)1.4 16V AFK 1390 100 Hatchback 4 01/00 - 06/04 SEAT CORDOBA Hatchback (6K2) 05/00 - 10/02 CORDOBA Hatchback (6K2) 1.4 16V AQQ 1390 100 Hatchback 02/00 - 10/02 CORDOBA Hatchback (6K2) 1.4 16V APE 1390 75 Hatchback 05/00 - 10/02 SEAT CORDOBA Vario (6K5) 06/99 - / CORDOBA Vario (6K5) 1.4 16V 1390 75 Estate 06/99 - / SEAT IBIZA III (6K1) 05/00 - 02/02 IBIZA III (6K1) 1.4 16V AQQ 1390 100 Hatchback 08/99 - 02/02 IBIZA III (6K1) 1.4 16V APE 1390 75 Hatchback 05/00 - 02/02 SEAT IBIZA IV (6L1) 02/02 - / IBIZA IV (6L1) 1.4 16V AUB 1390 100 Hatchback 02/02 - / SEAT INCA (6K9) 04/00 - / INCA (6K9) 1.4 16V AUA 1390 75 Box 04/00 - / SEAT LEON (1M1) 11/99 - / LEON (1M1) 1.4 16V APE 1390 75 Hatchback 11/99 - / SEAT TOLEDO II (1M2) 09/00 - 05/06 TOLEDO II (1M2) 1.4 16V AHW 1390 75 Saloon 07/99 - 05/06 TOLEDO II (1M2) 1.6 16V AUS 1598 105 Saloon 09/00 - 05/06
EGR036	EG10292- 12B1 036131503R 7.22785.15.0 7.22785.11.0		SEAT AROSA (6H) 01/00 - 06/04 AROSA (6H)1.4 16V AFK 1390 100 Hatchback 4 01/00 - 06/04 SEAT CORDOBA (6L2) 09/02 - / CORDOBA (6L2) 1.4 16V BBR 1390 75 Saloon 4 09/02 - / SEAT CORDOBA Hatchback (6K2) 05/00 - 10/02 CORDOBA Hatchback (6K2) 1.4 16V AQQ 1390 100 Hatchback 02/00 - 10/02 CORDOBA Hatchback (6K2) 1.4 16V APE 1390 75 Hatchback 05/00 - 10/02 SEAT IBIZA III (6K1) 05/00 - 02/02 IBIZA III (6K1) 1.4 16V AQQ 1390 100 Hatchback 08/99 - 02/02 IBIZA III (6K1) 1.4 16V APE 1390 75 Hatchback 05/00 - 02/02 SEAT IBIZA IV (6L1) 02/02 - / IBIZA IV (6L1) 1.4 16V AUB 1390 100 Hatchback 02/02 - / SEAT INCA (6K9) 04/00 - / INCA (6K9) 1.4 16V AUA 1390 75 Box 04/00 - / VOLKSWAGEN BORA (1J2) 05/00 - 05/05 BORA (1J2) 1.4 16V AHW 1390 75 Saloon 03/00 - 05/05 BORA (1J2) 1.6 16V AUS 1598 105 Saloon 05/00 - 05/05 VOLKSWAGEN BORA Estate (1J6) 02/00 - 05/05 BORA Estate (1J6) 1.4 16V BCA 1390 75 Estate 09/01 - 05/05 BORA Estate (1J6) 1.6 16V AUS 1598 105 Estate 02/00 - 05/05



Item	OE	Photo	Applicable model
EGR037	06A131501E EG10339-12B1 7.28070.03.0		SEAT ALHAMBRA (7V8, 7V9) 10/97 - / ALHAMBRA (7V8, 7V9) 1.8 T 20V AJH 7V8, 7V9 1781 150 MPV 10/97 - / VOLKSWAGEN SHARAN (7M8,7M9,7M6) 09/97 - / SHARAN (7M8, 7M9, 7M6) 1.8 T 20V AJH 7M8, 7M9, 7M6 1781 150 MPV 09/97 -
EGR038	5851057 55556720		OPEL AGILA (H00) 08/03 - / AGILA (H00) 1.0 Z10XEP 998 60 Estate 08/03 - / OPEL ASTRA H 03/04 - / ASTRA H 1.4 Z14XEP 1364 90 Hatchback 4 03/04 - / OPEL ASTRA H GTC 03/05 - / ASTRA H GTC 1.4 Z14XEP 1364 90 Hatchback 4 03/05 - / OPEL ASTRA H Estate 08/04 - / ASTRA H Estate 1.4 Z14XEP 1364 90 Estate 4 08/04 - / OPEL CORSA C (F08, F68) 06/03 - / CORSA C (F08, F68) 1.0 Z10XEP 998 60 Hatchback 3 06/03 - / CORSA C (F08, F68) 1.2 Twinport Z12XEP 1229 80 Hatchback 4 07/04 - / CORSA C (F08, F68) 1.4 Twinport Z14XEP 1364 90 Hatchback 4 06/03 - / OPEL CORSA C Box (F08, W5L) 07/05 - / CORSA C Box (F08, W5L) 1.2 Z12XEP 1229 80 Box 4 07/05 - / OPEL MERIVA 07/04 - / MERIVA 1.4 16V Twinport Z14XEP 1364 90 MPV 4 07/04 - / OPEL TIGRA TwinTop 06/04 - / TIGRA TwinTop 1.4 Z14XEP 1364 90 Convertible 06/04 - / VAUXHALL AGILA 09/00 - / AGILA 1.0 12V Z10XE 973 58 Estate 09/00 - / AGILA 1.2 16V Z12XE 1199 75 Estate 09/00 - / VAUXHALL ASTRA MK V Hatchback 03/04 -
EGR040	EGV541 17113534 12578044 17093134 17112963 17113279 EG10024		Chevrolet Astro (94-92) Chevrolet S10 Blazer (94-92) Chevrolet S10 Pickup (94-93) GMC S15 Jimmy (94-92) GMC S15 Pickup (94-92) GMC Safari (94-92) Oldsmobile Bravada (94-92)



Item	OE	Photo	Applicable model
EGR041	EGV617 12568589 17094098 17096198 17113282 17113642 17113644		Chevrolet Camaro (02-95) Pontiac Firebird (02-95)
EGR042	161859 1618.NR 9660276280 6NU010171-101 5S6Q9D475AE 5S6Q9D475AD 11717804950		PEUGEOT 206 CC (2D) 04/05 - / 206 CC (2D) 1.6 HDi FAP 110 1560 109 Convertible 04/05 - / PEUGEOT 206 SW (2E/K) 05/04 - / 206 SW (2E/K) 1.6 HDi FAP 110 1560 109 Estate 05/04 - / PEUGEOT 307 (3A/C) 02/04 - / 307 (3A/C) 1.6 HDi 110 9HY (DV6TED4) 1560 109 Hatchback 02/04 - / PEUGEOT 307 SW (3H) 02/04 - / 307 SW (3H) 1.6 HDi 110 9HY (DV6TED4) 1560 109 Estate 02/04 - / FORD FOCUS II (DA_) 01/05 - 00/00 FOCUS II (DA_) 1.6 TDCi HHDA 1560 90 Hatchback 4 01/05 - 00/00 PEUGEOT 307 Break (3E) 02/04 - / 307 Break (3E) 1.6 HDi 110 FAP 9HY (DV6TED4) 1560 109 Estate 02/04 - / PEUGEOT 407 (6D_) 05/04 - / 407 (6D_) 1.6 HDi 110 9HY (DV6TED4) 1560 109 Saloon 05/04 - / PEUGEOT 407 SW (6E_) 05/04 - / 407 SW (6E_) 1.6 HDi 110 9HY (DV6TED4) 1560 109 Estate 05/04 - / PEUGEOT 206 Hatchback (2A/C) 05/04 - / Mini ONE COOPER
EGR043	3M5Q-9D475-CA 1353152 1748265 3M5Q-9D475-EA 30750092		FOCUS C-MAX 1.6 TDCi FOCUS II (DA_) 1.6 TDCi FOCUS II Estate (DAW_) 1.6 TDCi FOCUS II Saloon (DA_) 1.6 TDCi C-MAX 1.6 TDCi S40 II (MS) 1.6 D V50 (MW) 1.6 D



Item	OE	Photo	Applicable model
EGR044	3M5Q-9D475-AC 3M5Q-9D475-DA 1229960 1313847 1254382 1748264		FOCUS C-MAX 1.6 TDCi FOCUS II (DA_) 1.6 TDCi FOCUS II Saloon (DA_) 1.6 TDCi
EGR045	1363591 1333611 1479845 1682736 2S6Q-9D475-BA 2S6Q-9D475-BB 2S6Q-9D475-BC		PEUGEOT 206 SW (2E/K) 07/02 - / 206 SW (2E/K) 1.4 HDi 8wn (DV4TD) 1398 68 Estate 07/02 - / PEUGEOT 1007 (KM_) 04/05 - / 1007 (KM_) 1.4 HDi 8wn (DV4TD) 1398 68 Hatchback 4 04/05 - / PEUGEOT 206 Hatchback (2A/C) 09/01 - / 206 Hatchback (2A/C) 1.4 HDi eco 70 8wn (DV4TD) 1398 68 Hatchback 09/01 - / FORD FIESTA V (JH_, JD_) 11/01 - /
EGR046	96612545		DAEWOO MATIZ (KLYA) 09/98 - / MATIZ (KLYA) 0.8 F8CV 796 52 Hatchback 09/98 - / DAEWOO MATIZ (KLYA) 98/09 - / MATIZ (KLYA) 0.8 F8CV 796 38 52 Hatchback 98/09 - / MATIZ (KLYA) 1.0 995 47 64 Hatchback





Item	OE	Photo	Applicable model
EGR048	1148330 1333574 1446265 2S7Q9D475BA 2S7Q9D475BB 2S7Q9D475BC 2S7Q9D475BD 14950		FORD MONDEO III (B5Y) 09/04 - / MONDEO III (B5Y) 2.0 16V TDDi / TDCi D6BA 1998 115 Hatchback 11/00 - / MONDEO III (B5Y) 2.0 TDCi 1998 130 Hatchback 10/01 - / MONDEO III (B5Y) 2.2 TDCi 2198 155 Hatchback 09/04 - / FORD MONDEO III Saloon (B4Y) 09/04 - / MONDEO III Saloon (B4Y) 2.0 16V TDDi / TDCi D6BA 1998 115 Saloon 11/00 - / MONDEO III Saloon (B4Y) 2.0 TDCi 1998 130 Saloon 10/01 - / MONDEO III Saloon (B4Y) 2.2 TDCi 2198 155 Saloon 09/04 - / FORD MONDEO III Estate (BWY) 09/04 - / MONDEO III Estate (BWY) 2.0 16V TDDi / TDCi D6BA 1998 115 Estate 11/00 - / MONDEO III Estate (BWY) 2.0 TDCi 1998 130 Estate 10/01 - / MONDEO III Estate (BWY) 2.2 TDCi 2198 155 Estate 09/04 - / FORD TRANSIT Flatbed/Chassis(FM__ , FN__ ) 03/04 - / TRANSIT Flatbed / Chassis (FM__ , FN__ ) 2.4 TDCi 2402 137 Flatbed /Chassis 03/04 - / FORD TRANSIT Bus (FD__ , FB__ , FS__ , FZ__ , FC__ ) 03/04 - / TRANSIT Bus (FD__ , FB__ , FS__ , FZ__ , FC__ ) 2.4 TDCi 2402 137 Bus 03/04 - / FORD TRANSIT Box (FA__ ) 03/04 - /
EGR049	1220819 1333572 2S7Q9D475AC 2S7Q9D475AD		FORD MONDEO III (B5Y) 11/00 - / MONDEO III (B5Y) 2.0 16V DI / TDDi / TDCi D5BA 1998 90 Hatchback 11/00 - / MONDEO III (B5Y) 2.0 16V TDDi / TDCi D6BA 1998 115 Hatchback 11/00 - / FORD MONDEO III Saloon (B4Y) 11/00 - / MONDEO III Saloon (B4Y) 2.0 16V DI / TDDi / TDCi D5BA 1998 90 Saloon 11/00 - / MONDEO III Saloon (B4Y) 2.0 16V TDDi / TDCi D6BA 1998 115 Saloon 11/00 - / FORD MONDEO III Estate (BWY) 11/00 - / MONDEO III Estate (BWY) 2.0 16V DI / TDDi / TDCi D5BA 1998 90 Estate 11/00 - / MONDEO III Estate (BWY) 2.0 16V TDDi / TDCi D6BA 1998 115 Estate 11/00 - / FORD TRANSIT Flatbed/Chassis(FM__ , FN__ ) 03/04 - / TRANSIT Flatbed / Chassis (FM__ , FN__ ) 2.4 DI (F_A_ , F_B_ , F_C_ , F_D_ ) D2FA 2402 90 Flatbed / Chassis 01/00 - / TRANSIT Flatbed / Chassis (FM__ , FN__ ) 2.4 DI (F_A_ , F_B_ , F_C_ , F_D_ ) D4FA 2402 120 Flatbed / Chassis 01/00 - / TRANSIT Flatbed / Chassis (FM__ , FN__ ) 2.4 TDE 2402 125 Flatbed /Chassis 07/01 - / TRANSIT Flatbed / Chassis (FM__ , FN__ ) 2.4 TDE 2402 115 Flatbed /Chassis 03/04 - / FORD TRANSIT Bus (FD__ , FB__ , FS__ , FZ__ , FC__ ) 07/01 - / TRANSIT Bus (FD__ , FB__ , FS__ , FZ__ , FC__ ) 2.4 DI (F_B_ , F_C_ , F_A_ ) D4FA 2402 120 Bus 01/00 - /

Item	OE	Photo	Applicable model
EGRB050	045131501L 045131501C 038131501E EG10312-12B1 7.24809.17.0		VOLKSWAGEN POLO CLASSIC (6KV2) 09/96 - 09/01 POLO CLASSIC (6KV2) 110 1.9 TDI AFN 1896 110 Saloon 06/98 - 09/01 POLO CLASSIC (6KV2) 90 1.9 TDI AHU 1896 90 Saloon 09/96 - 09/01 AUDI A2 (8Z0) 02/00 - 08/05 A2 (8Z0) 1.2 TDI ANY 8Z0 1191 61 Hatchback 3 03/01 - 08/05 A2 (8Z0) 1.4 TDI AMF 8Z0 1422 75 Hatchback 3 02/00 - 08/05 AUDI A3 (8L1) 08/97 - 07/01 A3 (8L1) 1.9 TDI ALH 8L1 1896 90 Hatchback 4 09/96 - 07/01 A3 (8L1) 1.9 TDI AXR 8L1 1896 100 Hatchback 4 10/00 - / A3 (8L1) 1.9 TDI ASV 8L1 1896 110 Hatchback 4 08/97 - 07/01 SEAT AROSA (6H) 01/00 - 06/04 AROSA (6H) 1.4 TDI AMF 1422 75 Hatchback 3 01/00 - 06/04 SEAT CORDOBA Hatchback (6K2) 06/99 - 10/02 CORDOBA Hatchback (6K2) 1.9 TDI ALH 1896 90 Hatchback 06/99 - 10/02 SEAT CORDOBA (6L2) 09/02 - / CORDOBA (6L2) 1.4 TDI AMF 1422 75 Saloon 10/02 - / CORDOBA (6L2) 1.9 TDI ATD 1896 100 Saloon 4 09/02 - / SEAT CORDOBA Vario (6K5) 06/99 - / CORDOBA Vario (6K5) 1.9 TDI 1896 90 Estate 06/99 - / SEAT IBIZA III (6K1) 08/99 - 02/02
EGR051	038131501AQ 1100628 XM219D475AA 038131501G 038129637B		AUDI A4 (8D2, B5) 03/00 - 11/00 A4 (8D2, B5) 1.9 TDI AJM 8D2, B5 1896 116 Saloon 4 03/00 - 11/00 AUDI A4 Avant (8D5, B5) 03/00 - 09/01 A4 Avant (8D5, B5) 1.9 TDI AJM 8D5, B5 1896 115 Estate 4 03/00 - 09/01 AUDI A6 (4B, C5) 07/00 - 01/05 A6 (4B, C5) 1.9 TDI AJM 4B,C5 1896 115 Saloon 4 07/00 - 01/05 AUDI A6 Avant (4B, C5) 07/00 - 01/05 A6 Avant (4B, C5) 1.9 TDI AJM 4B,C5 1896 115 Estate 4 07/00 - 01/05 SEAT ALHAMBRA (7V8, 7V9) 04/96 - / ALHAMBRA (7V8, 7V9) 1.9 TDI 1Z 7V8, 7V9 1896 90 MPV 04/96 - / SKODA SUPERB (3U4) 08/02 - 10/05 SUPERB (3U4) 1.9 TDI AVB 1896 101 Saloon 08/02 - 10/05 VOLKSWAGEN PASSAT (3B2) 08/99 - 11/00 PASSAT (3B2) 1.9 TDI AJM 1896 115 Saloon 08/98 - 11/00 PASSAT (3B2) 1.9 TDI AVB 1896 101 Saloon 02/00 - 11/00 PASSAT (3B2) 1.9 TDI 4motion AJM 1896 115 Saloon 08/99 - 11/00 VOLKSWAGEN PASSAT (3B3) 11/00 - 05/05 PASSAT (3B3) 1.9 TDI AVB 1896 101 Saloon 11/00 - 05/05 VOLKSWAGEN PASSAT Variant (3B5) 08/99 - 11/00 PASSAT Variant (3B5) 1.9 TDI AJM 1896 115 Estate 08/98 - 11/00

Item	OE	Photo	Applicable model
EGR052	038131501AT 038131501T 7.24809.26.0		AUDI A3 (8L1) 08/00 - / A3 (8L1) 1.9 TDI ASZ 8L1 1896 130 Hatchback 4 08/00 - / A3 (8L1) 1.9 TDI quattro ASZ 8L1 1896 130 Hatchback 4 08/00 - / SEAT IBIZA IV (6L1) 03/04 - / IBIZA IV (6L1) 1.9 TDI Cupra R BPX 1896 160 Hatchback 03/04 - / SEAT LEON (1M1) 05/02 - / LEON (1M1) 1.9 TDI ARL 1896 150 Hatchback 02/01 - / LEON (1M1) 1.9 TDI ASZ 1896 130 Hatchback 05/03 - / LEON (1M1) 1.9 TDI Syncro ARL 1896 150 Hatchback 05/02 - / SEAT TOLEDO II (1M2) 05/03 - 05/06 TOLEDO II (1M2) 1.9 TDI ARL 1896 150 Saloon 10/00 - 05/06 TOLEDO II (1M2) 1.9 TDI ASZ 1896 130 Saloon 05/03 - 05/06 SKODA OCTAVIA (1U2) 01/03 - / OCTAVIA (1U2) 1.9 TDI ASZ 1896 130 Hatchback 01/03 - / SKODA OCTAVIA Combi (1U5) 01/03 - / OCTAVIA Combi (1U5) 1.9 TDI ASZ 1896 130 Estate 01/03 - / VOLKSWAGEN BORA (1J2) 11/00 - 05/05 BORA (1J2) 1.9 TDI ARL 1896 150 Saloon 05/00 - 05/05 BORA (1J2) 1.9 TDI ASZ 1896 130 Saloon 11/00 - 05/05 BORA (1J2) 1.9 TDI 4motion ARL 1896 150 Saloon 05/00 - 05/05 BORA (1J2) 1.9 TDI 4motion ASZ 1896 130
EGR053	038131501AR 038131501M 0820110583 7283D		SEAT CORDOBA (6L2) 09/02 - / CORDOBA (6L2) 1.9 TDI ATD 1896 100 Saloon 4 09/02 - / SEAT IBIZA IV (6L1) 02/02 - / IBIZA IV (6L1) 1.9 TDI ATD 1896 100 Hatchback 02/02 - / SKODA FABIA (6Y2) 01/00 - / FABIA (6Y2) 1.9 TDI ATD 6Y2 1896 100 Hatchback 4 01/00 - / SKODA FABIA Combi (6Y5) 04/00 - / FABIA Combi (6Y5) 1.9 TDI ATD 6Y5 1896 100 Estate 4 04/00 - / SKODA FABIA Saloon (6Y3) 01/00 - / FABIA Saloon (6Y3) 1.9 TDI ATD 6Y3 1896 100 Saloon 4 01/00 - / SKODA OCTAVIA (1U2) 08/97 - / OCTAVIA (1U2) 1.9 TDI AGR 1896 90 Hatchback 09/96 - / OCTAVIA (1U2) 1.9 TDI AHF 1896 110 Hatchback 08/97 - / SKODA OCTAVIA Combi (1U5) 08/00 - / OCTAVIA Combi (1U5) 1.9 TDI AGR 1896 90 Estate 07/98 - / OCTAVIA Combi (1U5) 1.9 TDI AHF 1896 110 Estate 07/98 - / OCTAVIA Combi (1U5) 1.9 TDI 4x4 ATD 1896 100 Estate 09/00 - / OCTAVIA Combi (1U5) 1.9 TDI ATD 1896 100 Estate 4 08/00 - / VOLKSWAGEN POLO (9N_) 10/01 - /

Item	OE	Photo	Applicable model
EGR054	038131501AB 038131501AM 038129637L 7327D		SEAT CORDOBA (6L2) 10/02 - / CORDOBA (6L2) 1.9 TDI ASZ 1896 131 Saloon 10/02 - / SKODA FABIA (6Y2) 06/03 - / FABIA (6Y2) 1.9 TDI RS ASZ 1896 130 Hatchback 4 06/03 - / VOLKSWAGEN POLO (9N_) 11/03 - /
EGR055	038131501AL 038131501AA 7.24809.20.0 1119320 1212966 1461304 7327D 1M21-9D475-AA 6M21-9D475-AA YM21-9D475-AA		SEAT CORDOBA (6L2) 10/02 - / CORDOBA (6L2) 1.9 TDI ASZ 1896 131 Saloon 10/02 - / SKODA FABIA (6Y2) 06/03 - / FABIA (6Y2) 1.9 TDI RS ASZ 1896 130 Hatchback 4 06/03 - / VOLKSWAGEN POLO (9N_) 11/03 - /
EGR056	03G131501A 03G131501M 7451D		SEAT ALTEA (5P1) 04/04 - / ALTEA (5P1) 1.9 TDI BKC 1896 105 MPV 04/04 - / SEAT TOLEDO III (5P2) 10/04 - / TOLEDO III (5P2) 1.9 TDI BJB 1896 105 MPV 10/04 - / SKODA OCTAVIA (1Z3) 06/04 - / OCTAVIA (1Z3) 1.9 TDI BKC 1896 105 Hatchback 06/04 - / SKODA OCTAVIA Combi (1Z5) 11/04 - / OCTAVIA Combi (1Z5) 1.9 TDI BKC 1896 105 Estate 09/04 - / OCTAVIA Combi (1Z5) 1.9 TDI 4x4 1896 105 Estate 11/04 - / VOLKSWAGEN CADDY III Box (2KA, 2KH) 04/04 - / CADDY III Box (2KA, 2KH) 1.9 TDI BJB 1896 105 Box 04/04 - / VOLKSWAGEN CADDY III Estate (2KB, 2KJ) 04/04 - /

Item	OE	Photo	Applicable model
EGR057	070128070B 070128070E 7649D		VOLKSWAGEN MULTIVAN V (7HM, 7HF) 07/04 - / MULTIVAN V (7HM, 7HF) 2.5 TDI AXD 2461 130 MPV 04/03 - / MULTIVAN V (7HM, 7HF) 2.5 TDI AXE 2461 174 MPV 04/03 - / MULTIVAN V (7HM, 7HF) 2.5 TDI 4motion AXE 2461 174 MPV 5 07/04 - / MULTIVAN V (7HM, 7HF) 2.5 TDI 4motion AXD 2461 130 MPV 5 07/04 - / VOLKSWAGEN TRANSPORTER V Flatbed / Chassis (7JD, 7JE, 7JL, 7JY, 7JZ) 07/04 - / TRANSPORTER V Flatbed / Chassis (7JD, 7JE, 7JL, 7JY, 7JZ) 2.5 TDI AXD 2461 130 Flatbed /Chassis 04/03 - / TRANSPORTER V Flatbed / Chassis (7JD, 7JE, 7JL, 7JY, 7JZ) 2.5 TDI AXE 2461 174 Flatbed /Chassis 04/03 - / TRANSPORTER V Flatbed / Chassis (7JD, 7JE, 7JL, 7JY, 7JZ) 2.5 TDI 4motion AXD 2461 130 Flatbed /Chassis 07/04 - / VOLKSWAGEN TRANSPORTER V Bus (7HB, 7HJ) 08/04 - / TRANSPORTER V Bus (7HB, 7HJ) 2.5 TDI AXD 2461 130 Bus 04/03 - / TRANSPORTER V Bus (7HB, 7HJ) 2.5 TDI AXE 2461 174 Bus 04/03 - / TRANSPORTER V Bus (7HB, 7HJ) 2.5 TDI 4motion AXD 2461 130 Bus 07/04 - / TRANSPORTER V Bus (7HB, 7HJ) 2.5 TDI 4motion AXE 2461 174 Bus 07/04 - / TRANSPORTER V Bus (7HB, 7HJ) 2.5 TDI PF 2459 131 Bus 5 06/06 - / TRANSPORTER V Bus (7HB, 7HJ) 2.5 TDI
EGR058	7211D 849156 9192805 93170138 849124		OPEL OMEGA B Estate (21_, 22_, 23_) 97/09 - 00/09 OPEL VECTRA B Hatchback (38_) 96/11 - 00/06 OPEL VECTRA B (36_) 00/09 - 02/04 OPEL VECTRA B Estate (31_) 96/11 - 00/06 VAUXHALL OMEGA (B) 00/08 - 04/03 VAUXHALL OMEGA (B) Estate 98/01 - 00/09 VAUXHALL VECTRA (B) 00/09 - / VAUXHALL VECTRA (B) Hatchback 96/09 - 00/08 CHEVROLET ASTRA Hatchback 02/08 - / CHEVROLET ASTRA Saloon 02/08 - /



Item	OE	Photo	Applicable model
EGR059	849087 849105 90530760 9128573 90530760 849105 849087		<p>OPEL OMEGA B Estate (21_, 22_, 23_) 97/09 - 00/09 OMEGA B Estate (21_, 22_, 23_) 2.0 DTI 16V X 20 DTH 1995 74 101 Estate 97/09 - 00/09 OMEGA B Estate (21_, 22_, 23_) 2.2 DTI 16V Y 22 DTH 2171 88 120 Estate 00/09 - 03/07 OMEGA B Estate (21_, 22_, 23_) 2.2 DTI 16V Y 22 DTH 2171 81 110 Estate 00/09 - 03/07 OPEL ASTRA G Hatchback (F48_, F08_) 98/02 - 05/01 ASTRA G Hatchback (F48_, F08_) 2.0 DI Y 20 DTL 1995 60 82 Hatchback 98/02 - 05/01 ASTRA G Hatchback (F48_, F08_) 2.0 DTI 16V Y 20 DTH 1995 74 101 Hatchback 99/08 - 05/01</p>
EGR063	7.21943.05.0 WAV100220 14917		<p>LAND ROVER FREELANDER (LN) 1994 20 T2N 02/1998-11/2000 LAND ROVER FREELANDER Soft Top 1994 20 T2N 02/1998-10/2006 ROVER 200 (RF) 1994 20 T2R 11/1995- 03/2000 ROVER 200 (RF) 1994 20 T2N 11/1995- 03/2000 ROVER 400 (RT) 1994 20 T2N 05/1995- 03/2000 ROVER 400 (RT) 1994 20 T2R 11/1995- 03/2000 ROVER 400 Hatchback (RT) 1994 20 T2N 05/1995-03/2000 ROVER 400 Hatchback (RT) 1994 20 T2R 11/1995-03/2000 ROVER 600 (RH) 1994 20 T2N 12/1994- 02/1999</p>
EGR064	7.22074.03.0 ERR4047 14927 WAV 100330		<p>LAND ROVER DEFENDER Cabrio (LD) 2495 11 L; 16 L; 23 L 09/1990- LAND ROVER DEFENDER Cabrio (LD) 2495 09/1990-09/2001 LAND ROVER DEFENDER Station Wagon (LD) 2495 11 L; 16 L; 23 L 09/1990-12/1998 LAND ROVER DEFENDER Station Wagon (LD) 2495 09/1990-09/2001 LAND ROVER DISCOVERY (LJ, LG) 2496 12 L; 17 L; 19 L; 21 L 10/1989-10/1998 LAND ROVER RANGE ROVER Mk II (LP) 2497 25 6T (BMW) 07/1994-03/2002</p>



Item	OE	Photo	Applicable model
EGR065	7.21723.53.0 028131501E 028131501B 028131501A		AUDI 80 (8C, B4) 1.9 TD 09.91 - 12.94 75cv AUDI 80 (8C, B4) 1.9 TDI 09.91 - 12.94 90cv à partir 8C-R-136878 AUDI 80 Avant (8C, B4) 1.9 TDI 07.92 - 01.96 90cv à partir 8C-R-136878 AUDI A4 (8D2, B5) 1.9 TDI 10.95 - 11.00 110cv AUDI A4 (8D2, B5) 1.9 TDI quattro 09.96 - 11.00 110cv AUDI A4 (8D2, B5) 1.9 TDI 01.95 - 11.00 90cv AUDI A4 (8D2, B5) 1.9 TDI 12.95 - 11.00 75cv AUDI A4 Avant (8D5, B5) 1.9 TDI 03.96 - 09.01 75cv AUDI A4 Avant (8D5, B5) 1.9 DUO 03.98 - 09.01 90cv AUDI A4 Avant (8D5, B5) 1.9 TDI quattro 09.96 - 09.01 110cv AUDI A4 Avant (8D5, B5) 1.9 TDI 02.96 - 09.01 90cv AUDI A4 Avant (8D5, B5) 1.9 TDI 02.96 - 09.01 110cv AUDI A6 (4A, C4) 1.9 TDI 06.94 - 10.97 90cv AUDI A6 (4B, C5) 1.9 TDI 04.97 - 10.00 110cv AUDI A6 Avant (4A, C4) 1.9 TDI 06.94 - 12.97 90cv AUDI A6 Avant (4B, C5) 1.9 TDI 02.98 - 04.01 110cv AUDI CABRIOLET (8G7, B4) 1.9 TDI 06.95 - 08.00 90cv
EGR066	7.21675.56.0 074131503 91799320		VW VOLVO AUDI 100 (C4) 2.5 TDI 115 CV - de 12/1990 à 06/1994 100 (C4) Avant 2.5 TDI 115 CV - de 12/1990 à 06/1994 A6 (C4) 2.5 TDI 140 CV - de 08/1994 à 02/1997 2.5 TDI quattro 140 CV - de 10/1995 à 02/1997 A6 (C4) Avant 2.5 TDI 140 CV - de 08/1994 à 12/1997 2.5 TDI 116 CV - de 06/1994 à 12/1997 2.5 TDI quattro 140 CV - de 07/1995 à 12/1997
EGR067	7.22011.53.0 7700100230 7700102850 7700105136 7700108141 7700858510		RENAULT LAGUNA Grandtour K56_ 2.2 D 1995 to 2001 [G8T 706] Engine Code: G8T 706  (VID:6441)RENAULT LAGUNA Grandtour K56_ 2.2 D 1995 to 2001 [G8T 752] Engine Code: G8T 706  (VID:6442)RENAULT LAGUNA Grandtour K56_ 2.2 D 1995 to 2001 [G8T 790] Engine Code: G8T 706  (VID:6443)RENAULT LAGUNA Grandtour K56_ 2.2 D 1995 to 2001 [G8T 794] Engine Code: G8T 706





Item	OE	Photo	Applicable model
EGR068	7.21428.70.0 92 4F 8D475 BA		FORD TRANSIT
EGR069	7.21675.56.0 91799320 074131503		VOLVO 850 (LS) 2.5 TDI VOLVO 850 Estate (LW) 2.5 TDI VOLVO S70 (LS) 2.5 TDI VOLVO S80 I (TS, XY) 2.5 TDI
EGR071	7.00147.02 66114034A0 6611403460		MUSSO (SPORTS) REXTON KORANDO
EGR072	9015237		BUICK
EGR075	4M5Q9424CD 1563296 555306		FORD C-MAX 1.8 TDCi FORD FOCUS C-MAX 1.8 TDCi FORD FOCUS II Estate (DA_) 1.8 TDCi FORD GALAXY 1.8 TDCi FORD MONDEO IV 1.8 TDCi FORD S-MAX 1.8 TDCi FORD TOURNEO CONNECT 1.8 Di FORD TRANSIT CONNECT (P65_, P70_, P80_) 1.8 Di





Item	OE	Photo	Applicable model
EGR076	03L131501E 03L131501D 03L131501G		Q5 2.0 TDI quattro (125kw) A4 Avant 2.0 TDI (105kw)A4 Avant 2.0 TDI quattro (105kw)
EGR077	03G131501J 03G131501R 03G131501B 03G131501Q 408-275-002-001 A2C53060455		AUDI A4 Saloon 2.0 TDI Compatibility...  (VID:30878)AUDI A4 Saloon 8K2, B8 2.0 TDI 1968cc  from 2008, [CAHA], DOHC, 16v, 170BHP
EGR078	1668578 4M5Q9424BE ERV239		AUDI A6 AVANT 2.0 TDI 2005 TO 2008 FORD GALAXY 1.8 TDCi FORD S-MAX 1.8 TDCi FORD TRANSIT CONNECT (P65_, P70_, P80_) 1.8 Di FORD TRANSIT CONNECT (P65_, P70_, P80_) 1.8 TDCi
EGR079	1119890 1134210 1S7G9D475AF 1S7G9D475AH 20LF01300 LF0120300Z08 30658187 31251243AA 8694697A		Ford Mondeo                      Focus 2.0
EGR080	038131501AF 038131501AN 038129637D 038131501S		SKODA OCTAVIA 2.0 TDI 16V  Compatibility...  (VID:21495)SKODA OCTAVIA 1Z3 2.0 TDI  16V 1968cc



Item	OE	Photo	Applicable model
EGR081	045131501F 045131501K 7271D		A2 1.4 TDI (55kw) A2 1.4 TDI (66kw)
EGR082	1618GZ 161831 1618S8 71793028 71793404 1231964 1436390 6M5Q9D475AA 6M5Q9D475BA		<p>Citroen - Engine 2.0 HDI C4 2004+ [HP 136 &amp; 140] C4 Coupe 2004+ [HP 136 &amp; 140] C4 Picasso 2007+ [HP 136 &amp; 150] C4 Grand Picasso 2006+ [HP 136 &amp; 150] C5 2008+ [HP 136, 140 &amp; 163] C5 Saloon 2008+ [HP 136, 140 &amp; 163] C5 Break 2008+ [HP 136, 140 &amp; 163] C8 2006+ [HP 136] Dispatch 2007+ [HP 136 &amp; 140]</p> <p>Fiat - Engine 2.0 D Multijet: Ulysse 2006+ [HP 120 &amp; 136] Scudo 2007+ [HP 120 &amp; 136]</p> <p>Ford - Engine 2.0 TDCi: C-Max 2007+ [HP 110 &amp; 136] Focus 2004+ [HP 110 &amp; 136] Focus C-Max 2003-2010 [HP 136] Modeo Mk IV 2007+ [HP 115 &amp; 130] Galaxy 2006+ [HP 115, 130 &amp; 140]</p> <p>Peugeot - 2.0 HDI: 307 2003+ [HP 136] 307 SW 2004+ [HP 136] 307cc 2005+ [HP 136] 307 Estate 2004+ [HP 136] 308 2007+ [HP 136] 407 2004+ [HP 136 &amp; 140] 407 Saloon 2004+ [HP 136 &amp; 140] 407 SW 2004+ [HP 126, 136 &amp; 140] 407 Coupe 2005+ [HP 136 &amp; 163] Expert 2000+ [HP 94 &amp; 136]</p>

Item	OE	Photo	Applicable model
EGR084	5851040 5851579 5851580 12565517 12569552 12571041 5851040 14950		OPEL ASTRA G Saloon (F69_) 03/01 - 01/05 ASTRA G Saloon (F69_) 2.2 16V Z22SE 2198 147 Saloon 4 03/01 - 01/05 OPEL ASTRA G Hatchback (F48_, F08_) 03/01 - 01/05 ASTRA G Hatchback (F48_, F08_) 2.2 16V Z22SE 2198 147 Hatchback 03/01 - 01/05 OPEL ASTRA G Estate (F35_) 03/01 - 07/04 ASTRA G Estate (F35_) 2.2 16V Z22SE 2198 147 Estate 03/01 - 07/04 OPEL VECTRA B (36_) 09/00 - 04/02 VECTRA B (36_) 2.2 i 16V Z22SE 2198 147 Saloon 09/00 - 04/02 OPEL VECTRA B Hatchback (38_) 09/00 - 07/03 VECTRA B Hatchback (38_) 2.2 i 16V Z22SE 2198 147 Hatchback 09/00 - 07/03 OPEL VECTRA B Estate (31_) 09/00 - 07/03 VECTRA B Estate (31_) 2.2 i 16V Z22SE 2198 147 Estate 09/00 - 07/03 OPEL ZAFIRA (F75_) 09/00 - 06/05 ZAFIRA (F75_) 2.2 16V Z22SE 2198 147 MPV 09/00 - 06/05 VAUXHALL VECTRA 09/00 - / VECTRA 2.2 i 16V Z22SE 2198 147 Saloon 09/00 - / VAUXHALL VECTRA Hatchback 09/00 - / VECTRA Hatchback 2.2 i 16V Z22SE 2198 147 Hatchback 09/00 - / VAUXHALL VECTRA Estate 09/00 - / VECTRA Estate 2.2 i 16V Z22SE 2198 147 Estate 09/00 - / VAUXHALL ZAFIRA 09/00 - /
EGR085	3C349F452AC 3C3Z9F452AC 4C3Z9F452A CX1959 5C3Z9F452AA		2004 Ford E350 Van EGR Valve for V8 6.0L Turbo Diesel 2004 Ford E450 Van EGR Valve for V8 6.0L Turbo Diesel 2003-04 Ford Excursion EGR Valve for V8 6.0L Turbo Diesel 2003-04 Ford F250 Truck EGR Valve for V8 6.0L Turbo Diesel 2003-04 Ford F350 Truck EGR Valve for V8 6.0L Turbo Diesel 2003-04 Ford F450 Truck EGR Valve for V8 6.0L Turbo Diesel 2003-04 Ford F550 Truck EGR Valve for V8 6.0L Turbo Diesel
EGR086	1366049 1383634 1477144 1563499 6S7Q-9D475-AA 6S7Q-9D475-AC 6S7Q-9D475-AD 6S7Q-9D475-AE 6S7Q-9D475-AG		Ford Mondeo/Jaguar X-Type FORD MONDEO MK3 2000-2007 2.2 16V 150HP MONDEO III Saloon (B4Y) MONDEO III (B5Y) MONDEO III Clipper (BWY) X-TYPE (CF1) X-TYPE Estate

Item	OE	Photo	Applicable model
EGR087	1480549 8C1Q9D475AA		PEUGEOT FIAT FORD TRANSIT MK7 2.2 2.4 LANDROVER CITROEN
EGR088	8C1Q9D475BA 1466340 6C1Q9D475AF 6C1Q9D475AG 1480560 1618R5 1618HQ 9665752480 9659694780		PEUGEOT BOXER Bus 2.2 HDi 100 PEUGEOT BOXER Box 2.2 HDi 10 PEUGEOT BOXER Platform/Chassis 2.2 HDi 10 FIAT DUCATO Bus (250) 100 Multijet 2,2 D FIAT DUCATO Box (250) 100 Multijet 2,2 D FIAT DUCATO Platform/Chassis (250) 100 Multijet 2,2 D FORD TRANSIT Bus 2.2 TDCi FORD TRANSIT Box 3.2 TDCi FORD TRANSIT TOURNEO 2.2 TDCi LANDROVER DEFENDER Cabrio (LD) 2.4 Td4 LANDROVER DEFENDER Station Wagon (LD) 2.4 Td4 LANDROVER DEFENDER Pickup (LD_) 2.4 Td4 CITROEN JUMPER Bus 2.2 HDi 100 CITROEN JUMPER Box 2.2 HDi 100 CITROEN JUMPER Platform/Chassis 2.2 HDi 100
EGR089	7.03784.05.0 BK2Q9D475CB		Ford Transit 2.2L Turbo Diesel
EGR090	7.01621.04.0 9C1Q9D475AB		FORD TRANSIT MK7 EGR VALVE 2.2/ 2.4 TDCi WATER-COOLED 2008 ON 9C1Q9D475AB FORD TRANSIT MK7 EGR VALVE 2.2/ 2.4 TDCi WATER-COOLED 2008 ON



Item	OE	Photo	Applicable model
EGR091	LR018465 1618N7 JDE3314 C2C40183 LR006995		CITROENC6 (TD_) (2005/09 - /) C6 (TD_) 2.7 HDi UHZ (DT17BTED4) 2720 150 204 Saloon 05/09 - / CITROENC5 (RD_) (2008/02 - /) C5 (RD_) 2.7 HDi DT17ED4 2720 150 204 Saloon 08/02 - / JAGUARS-TYPE (CCX) (1999/01 - /) S-TYPE (CCX) 2.7 D 2720 152 207 Saloon 04/06 - / LAND ROVERDISCOVERY III (TAA) (2004/07 - /) DISCOVERY III (TAA) 2.7 TD 276DT 2720 140 190 Closed Off-Road Vehicle 04/07 - / LAND ROVERRANGE ROVER SPORT (LS) (2005/02 - /) RANGE ROVER SPORT (LS) 2.7 TDVM 276DT 2720 140 190 Closed Off-Road Vehicle 05/02 - / PEUGEOT607 (9D, 9U) (2000/01 - /) 607 (9D, 9U) 2.7 HDi 24V DT17TED4 2721 150 204 Saloon 04/12 - / PEUGEOT407 (6D_) (2004/05 - /) 407 (6D_) 2.7 HDi UHZ (DT17) 2720 150 204 Saloon 05/10 - / PEUGEOT407 SW (6E_) (2004/05 - /) 407 SW (6E_) 2.7 HDi UHZ (DT17) 2720 150 204 Estate 05/10 - / PEUGEOT407 Coupe (6C_) (2005/10 - /) 407 Coupe (6C_) 2.7 HDi UHZ (DT17) 2720 150 204 Coupe 05/10 - /
EGR092	LR018466 1618n6 1618QF JDE8785 JDE3315 LR006994 WAV500210		CITROENC6 (TD_) (2005/09 - /) C6 (TD_) 2.7 HDi UHZ (DT17BTED4) 2720 150 204 Saloon 05/09 - / CITROENC5 (RD_) (2008/02 - /) C5 (RD_) 2.7 HDi DT17ED4 2720 150 204 Saloon 08/02 - / CITROENC5 Break (TD_) (2008/02 - /) C5 Break (TD_) 2.7 HDi UHZ (DT17BTED4) 2720 150 204 Estate 08/02 - / JAGUARS-TYPE (CCX) (1999/01 - /) S-TYPE (CCX) 2.7 D 2720 152 207 Saloon 04/06 - / JAGUARXJ (X350, X358) (2003/05 - /) XJ (X350, X358) 6 2,7 D 2720 152 207 Saloon 05/10 - / JAGUARXF (_J05_, CC9) (2008/03 - /) XF (_J05_, CC9) 2.7 D AJD 2720 152 207 Saloon 08/03 - / LAND ROVERDISCOVERY III (TAA) (2004/07 - /) DISCOVERY III (TAA) 2.7 TD 276DT 2720 140 190 Closed Off-Road Vehicle 04/07 - / LAND ROVERRANGE ROVER SPORT (LS) (2005/02 - /) RANGE ROVER SPORT (LS) 2.7 TDVM 276DT 2720 140 190 Closed Off-Road Vehicle 05/02 - / PEUGEOT607 (9D, 9U) (2000/01 - /) 607 (9D, 9U) 2.7 HDi 24V DT17TED4 2721 150 204 Saloon 04/12 - / PEUGEOT407 (6D_) (2004/05 - /) 407 (6D_) 2.7 HDi UHZ (DT17) 2720 150



Item	OE	Photo	Applicable model
EGR093	1J0906283C		AUDI A1 (8X1) , 05.1... 1.6 TDI, 05/10-, 77kW 05.10 77 - AUDI A1 (8X1) , 05.1... 1.6 TDI, 03/11-, 66kW 03.11 66 - AUDI A1 (8X1) , 05.1... 2.0 TDI, 09/11-, 105kW 09.11 105 - AUDI A1 (8X1) , 05.1... 2.0 TDI, 05/12-, 100kW 05.12 100 - AUDI A1 Sportback (8... 2.0 TDI, 09/11-, 105kW 0 - AUDI A1 Sportback (8... 1.6 TDI, 11/11-, 66kW 11.11 66 - AUDI A1 Sportback (8... 1.6 TDI, 11/11-, 77kW 11.11 77 - AUDI A1 Sportback (8... 2.0 TDI, 05/12-, 100kW 05.12 100 - AUDI A3 (8P1) , 05.0... 2.0 TDI 16V, 05/03-08/12,... 05.03 103 - AUDI A3 (8P1) , 05.0... 1.9 TDI, 05/03-05/10, 77k... 05.03 77 - 1 to 10 of 676 entries
EGR094	03C131503B		AUDI A3 (8P1) (2003/05 - /) A3 (8P1) 1.6 FSI BLP 1598 85 115 Hatchback 03/08 - / AUDIA3 Sportback (8PA) (2004/09 - /A3 Sportback (8PA) 1.6 FSI BLP 1598 85 115 Hatchback 04/09 - / SKODAOCTAVIA (1Z3) (2004/02 - /) OCTAVIA (1Z3) 1.6 FSI BLF 1598 85 115 Hatchback 04/02 - 08/10 SKODAOCTAVIA Combi (1Z5) (2004/02 - /) OCTAVIA Combi (1Z5) 1.6 FSI BLF 1598 85 115 Estate 04/02 - 08/10 VWPOLO (9N_) (2001/10 - /) POLO (9N_) 1.4 FSI AXU 1390 63 86 Hatchback 02/02 - 06/07 VWTOURAN (1T1, 1T2, 1T3) (2003/02 - /) TOURAN (1T1, 1T2, 1T3) 1.6 FSI BLP 1598 85 115 MPV 03/02 - 07/01 VWGOLF V (1K1) (2003/10 - 2009/02) GOLF V (1K1) 1.6 FSI BLP 1598 85 115 Hatchback 03/10 - 08/07 GOLF V (1K1) 1.4 FSI BLN 1390 66 90 Hatchback 03/10 - 06/07 VWGOLF PLUS (5M1, 521) (2005/01 - /) GOLF PLUS (5M1, 521) 1.6 FSI BLF 1598 85 115 Hatchback 05/01 - 08/05 GOLF PLUS (5M1, 521) 1.4 FSI BLN 1390 66 90 Hatchback 05/07 - / VWPASSAT (3C2) (2005/03 - /) PASSAT (3C2) 1.6 FSI BLF 1598 85 115 Saloon 05/03 - 08/06 VWJETTA III (1K2) (2005/08 - 2010/10)



Item	OE	Photo	Applicable model
EGR095	8200327004 8200797706 8200327011 8200691292 8200797707 8200797709 8200797710 8200797713 8200797714 8200797716 8200797719 8200797721 8200797723 8200797724 8200797726 8200797727		RENAULTLAGUNA II (BG0/1_) (2001/03 - /) LAGUNA II (BG0/1_) 2.0 dCi (BG1S) M9R 760 1995 127 173 Hatchback 06/01 - / LAGUNA II (BG0/1_) 2.0 dCi (BG1T) M9R 740 1995 110 150 Hatchback 05/08 - / RENAULTLAGUNA II Grandtour (KG0/1_) (2001/03 - /) LAGUNA II Grandtour (KG0/1_) 2.0 dCi (KG1T) M9R 740 1995 110 150 Estate 05/08 - / LAGUNA II Grandtour (KG0/1_) 2.0 dCi (KG1S) M9R 760 1995 127 173 Estate 06/01 - / RENAULTTRAFIC II Bus (JL) (2001/03 - /) TRAFIC II Bus (JL) 2.0 dCi 115 (JL0H) M9R 786 1995 84 114 Bus 06/08 - / RENAULTTRAFIC II Box (FL) (2001/03 - /) TRAFIC II Box (FL) 2.0 dCi 90 (FL0H) M9R 782 1995 66 90 Box 06/08 - / TRAFIC II Box (FL) 2.0 dCi 115 (FL0H) M9R 786 1995 84 114 Box 06/08 - / RENAULTVEL SATIS (BJ0_) (2002/06 - /) VEL SATIS (BJ0_) 2.0 dCi (BJ03) M9R 762 1995 127 173 MPV 06/01 - / RENAULTSPACE IV (JK0/1_) (2002/11 - /) SPACE IV (JK0/1_) 2.0 dCi (JK01, JK02) M9R 750 1995 110 150 MPV 06/01 - / SPACE IV (JK0/1_) 2.0 dCi (JK03, JK04) M9R 763 1995 127 173 MPV 06/01 - / RENAULTMEGANE II (BM0/1_, CM0/1_)
EGR096	A2C53322451 8200850755 18111-67JG5 18111-67JG4 H8200194323 18111-67JG4-000 147106672R 18111-67JG5-LCP		RENAULT KOLEOS, LAGUNA, MEGANE, MEGANE CC, TRAFIC II

Item	OE	Photo	Applicable model
EGR097	06F131503A 06F131503B 408265001002Z 83819 V10630053 88113		AUDIA3 (8P1) (2003/05 - /) A3 (8P1) 2.0 FSI BVZ 1984 110 150 Hatchback 03/05 - / AUDIA3 Sportback (8PA) (2004/09 - /) SEATALTEA (5P1) (2004/03 - /) ALTEA (5P1) 2.0 FSI BVZ 1984 110 150 MPV 04/05 - 09/03 SEATTOLEDO III (5P2) (2004/04 - 2009/05) TOLEDO III (5P2) 2.0 FSI BVZ 1984 110 150 MPV 04/10 - 09/05 SEATLEON (1P1) (2005/05 - /) LEON (1P1) 2.0 FSI BVZ 1984 110 150 Hatchback 05/07 - 10/05 SEATALTEA XL (5P5, 5P8) (2006/10 - /) ALTEA XL (5P5, 5P8) 2.0 FSI BVZ 1984 110 150 MPV 06/10 - 09/03 SKODAOCTAVIA (1Z3) (2004/02 - /) OCTAVIA (1Z3) 2.0 FSI BVZ 1984 110 150 Hatchback 04/11 - / SKODAOCTAVIA Combi (1Z5) (2004/02 - /) OCTAVIA Combi (1Z5) 2.0 FSI BVZ 1984 110 150 Estate 04/11 - / OCTAVIA Combi (1Z5) 2.0 FSI 4x4 BVX 1984 110 150 Estate 04/11 - / VWTOURAN (1T1, 1T2, 1T3) (2003/02 - /) TOURAN (1T1, 1T2, 1T3) 2.0 FSI BVZ 1984 110 150 MPV 03/10 - / VWGOLF V (1K1) (2003/10 - 2009/02) GOLF V (1K1) 2.0 FSI BVZ 1984 110 150 Hatchback 04/01 - 08/11 GOLF V (1K1) 2.0 FSI 4motion BVX 1984
EGR098	03G131502B 03G131501N 555192 70090700 7.00907.02.0 7.00907.01 V10-63-0014 83.840		AUDIA3 (8P1)(2003/05 - /) A3 (8P1) 1.9 TDI BXE 1896 77 105 Hatchback 03/05 - / A3 (8P1) 2.0 TDI BMM 1968 103 140 Hatchback 05/06 - / A3 (8P1) 2.0 TDI quattro BMM 1968 103 140 Hatchback 06/01 - / AUDIA3 Sportback (8PA) (2004/09 - /) A3 Sportback (8PA) 2.0 TDI BMM 1968 103 140 Hatchback 05/06 - / A3 Sportback (8PA) 2.0 TDI quattro BMM 1968 103 140 Hatchback 06/01 - / A3 Sportback (8PA) 1.9 TDI BXE 1896 77 105 Hatchback 04/09 - / AUDIA3 Convertible (2008/04 - /) A3 Convertible 1.9 TDI BLS 1896 77 105 Convertible 08/04 - / SEATIBIZA IV (6L1) (2002/02 - 2009/11) IBIZA IV (6L1) 1.9 TDI BMT 1896 74 100 Hatchback 02/02 - 09/11 IBIZA IV (6L1) 1.4 TDI BNV 1422 59 80 Hatchback 05/06 - 09/11 SEATCORDOBA (6L2) (2002/09 - 2009/11) CORDOBA (6L2) 1.4 TDI BNV 1422 59 80 Saloon 05/06 - 09/11 CORDOBA (6L2) 1.9 TDI BMT 1896 74 100 Saloon 02/09 - 09/11 SEATALTEA (5P1) (2004/03 - /) SEATTOLEDO III (5P2) (2004/04 - 2009/05) TOLEDO III (5P2) 1.9 TDI BXE 1896 77 105 MPV 04/10 - 09/05 TOLEDO III (5P2) 2.0 TDI BMM 1968 103



Item	OE	Photo	Applicable model
EGR099	14710-EC00D 14710-EC00B 14719-EC00AX2		Nissan,CABSTAR 2000> 2.5DT Truck,09/06-10/11 Nissan,NAVARA D40 2.5DT P/Up,09/06-01/10 Nissan,NP300 2.5DT P/Up,01/08- Nissan,NP300 2.5DT P/Up,01/08- Nissan,PATHFINDER 2.5DT Fd Est - dCi,09/06-01/10
EGR100	14710-MA70A		Nissan,CABSTAR 2000> 2.5DT Truck,09/06-10/11 Nissan,NAVARA D40 2.5DT P/Up,09/06-01/10 Nissan,NP300 2.5DT P/Up,01/08- Nissan,NP300 2.5DT P/Up,01/08- Nissan,PATHFINDER 2.5DT Fd Est - dCi,09/06-01/10
EGR101	070128070F 070128070C		VW TOUAREG (7LA, 7L6, 7L7) (2002/10 - 2010/05) TOUAREG (7LA, 7L6, 7L7) 2.5 R5 TDI BPE 2461 128 174 Closed Off-Road Vehicle 03/01 - 10/05 TOUAREG (7LA, 7L6, 7L7) 2.5 R5 TDI BPD 2461 120 163 Closed Off-Road Vehicle 03/08 - 10/05

Item	OE	Photo	Applicable model
EGR102	17094174 46477364 71788527		FIATTEMPRA (159) (1990/03 - 1998/12) TEMPRA (159) 1.6 i.e. (159.AS, 159.AT) 835 C1.000 1581 55 75 Saloon 92/06 - 96/08 TEMPRA (159) 1.6 i.e. (159.AJ) 159 B9.000 1581 66 90 Saloon 94/06 - 96/08 TEMPRA (159) 1.6 i.e. (159.AJ) 159 B9.000 1581 63 87 Saloon 94/06 - 96/08 TEMPRA (159) 1.6 159 A3.048 1581 51 69 Saloon 90/04 - 93/06 FIATTEMPRA S.W. (159) (1990/03 - 1997/08) TEMPRA S.W. (159) 1.6 159 A3.048 1581 51 69 Estate 93/07 - 96/07 TEMPRA S.W. (159) 1.6 i.e. (159.AJ) 159 B9.000 1581 66 90 Estate 94/06 - 96/08 TEMPRA S.W. (159) 1.6 i.e. (159.AS, 159.AT) 835 C1.000 1581 55 75 Estate 92/10 - 96/08 TEMPRA S.W. (159) 1.6 i.e. (159.AE) 835 C1.000 1581 57 78 Estate 90/10 - 96/08 FIATPUNTO (176) (1993/09 - 1999/09) PUNTO (176) 90 1.6 176 A9.000 1581 65 88 Hatchback 94/01 - 97/04 FIATPUNTO Convertible (176C) (1994/04 - 2000/06) PUNTO Convertible (176C) 90 1.6 176 A9.000 1581 65 88 Convertible 94/04 - 97/04 LANCIADEDRA (835) (1989/01 - 1999/07) DEDRA (835) 1.6 LE (835EB) CAT 159 B9.000 1581 66 90 Saloon 94/07 - 99/07 DEDRA (835) 1.6 i.e. (835AN) 835 C1.000
EGR103	4415923 8200374875 93183942		NISSANINTERSTAR Bus (X70) (2002/07 - /) NISSANINTERSTAR Box (X70) (2002/07 - /) OPELVIVARO Box (F7) (2001/08 - /) OPELVIVARO Combi (J7) (2001/08 - /) OPELVIVARO Platform/Chassis (E7) (2006/01 - /) RENAULTSPACE III (JE0_) (1996/11 - 2002/10) RENAULTMASTER II Box (FD) (1998/07 - /) RENAULTMASTER II Platform/Chassis (ED/HD/UD) (1998/07 - /) RENAULTMASTER II Bus (JD) (1998/03 - /) RENAULTLAGUNA II (BG0/1_) (2001/03 - /) RENAULTLAGUNA II Grandtour (KG0/1_) (2001/03 - /) RENAULTAVANTIME (DE0_) (2001/09 - 2003/05) RENAULTSPACE IV (JK0/1_) (2002/11 - /) VAUXHALLVIVARO Combi (J7) (2001/08 - /) VAUXHALLVIVARO Box (F7) (2001/08 - /) VAUXHALLVIVARO Platform/Chassis (E7)

Item	OE	Photo	Applicable model
EGR104	1618T1 9656911780 1427355, 6G9Q9D475AA 7.00578.05 70057805 700578050 7.00578.12 70057812 700578120 LR000997 7518142		CITROENC-CROSSER (EP_) (2007/02 - /) C-CROSSER (EP_) 2.2 HDi 4HN (DW12MTED4) 2179 115 156 Closed Off-Road Vehicle 07/02 - / FIATULYSSE (179AX) (2002/08 - /) ULYSSE (179AX) 2.2 D Multijet 4HT (DW12BTED4) 2179 125 170 MPV 08/03 - / FORDGALAXY (2006/05 - /) GALAXY 2.2 TDCi Q4WA 2179 129 175 MPV 08/03 - / FORDS-MAX (2006/05 - /) S-MAX 2.2 TDCi Q4WA 2179 129 175 MPV 08/03 - / FORDMONDEO IV Saloon (2007/03 - /) MONDEO IV Saloon 2.2 TDCi Q4BA 2179 129 175 Saloon 08/03 - / FORDMONDEO IV (2007/03 - /) MONDEO IV 2.2 TDCi Q4BA 2179 129 175 Hatchback 08/03 - / FORDMONDEO IV Turnier (2007/03 - /) MONDEO IV Turnier 2.2 TDCi Q4BA 2179 129 175 Estate 08/03 - / PEUGEOT607 (9D, 9U) (2000/01 - /) 607 (9D, 9U) 2.2 HDi 4HT (DW12BTED4) 2179 125 170 Saloon 06/05 - / PEUGEOT807 (E) (2002/06 - /) 807 (E) 2.2 HDi 4HT (DW12BTED4) 2179 125 170 MPV 06/06 - / PEUGEOT407 (6D_) (2004/05 - /) 407 (6D_) 2.2 HDi 4HP (DW12BTED4) 2179 120 163 Saloon 08/06 - / 407 (6D_) 2.2 HDi 170 4HT (DW12BTED4) 2179 125 170 Saloon 06/05 - / BMW7 (E38) (1994/10 - 2001/11) 7 (E38) 730 d M57 D30 2926 135 184 Saloon 98/08 - 00/04 7 (E38) 740 d M67 D39 3901 180 245 Saloon 99/05 - 01/11 7 (E38) 730 d M57 306 D1 2926 142 193 Saloon 00/04 - 01/11 BMW5 (E39) (1995/11 - 2003/06) 5 (E39) 530 d M57 D30 2926 142 193 Saloon 00/09 - 03/06 5 (E39) 520 d M47 D20 1951 100 136 Saloon 00/02 - 03/06 5 (E39) 525 d M57 D25 2497 120 163 Saloon 00/02 - 03/06 5 (E39) 530 d M57 D30 2926 135 184 Saloon 98/08 - 00/09 BMW5 Touring (E39) (1997/01 - 2004/05) 5 Touring (E39) 530 d M57 D30 2926 135 184 Estate 98/08 - 00/09 5 Touring (E39) 525 d M57 D25 2497 120 163 Estate 00/02 - 04/05 5 Touring (E39) 520 d M47 D20 1951 100 136 Estate 00/02 - 03/09 5 Touring (E39) 530 d M57 D30 2926 142 193 Estate 00/09 - 04/05 BMW3 (E46) (1998/02 - 2005/04) 3 (E46) 320 d M47 D20 1951 100 136 Saloon 98/04 - 01/09 3 (E46) 330 d M57 D30 2926 135 184 Saloon 99/10 - 05/02 3 (E46) 330 xd M57 D30 2926 135 184 Saloon 00/06 - 05/02 3 (E46) 320 d M47N 204 D4 1995 110 150
EGR105	7.22796.01.0 7796634 11 742247906 2247906		BMW7 (E38) (1994/10 - 2001/11) 7 (E38) 730 d M57 D30 2926 135 184 Saloon 98/08 - 00/04 7 (E38) 740 d M67 D39 3901 180 245 Saloon 99/05 - 01/11 7 (E38) 730 d M57 306 D1 2926 142 193 Saloon 00/04 - 01/11 BMW5 (E39) (1995/11 - 2003/06) 5 (E39) 530 d M57 D30 2926 142 193 Saloon 00/09 - 03/06 5 (E39) 520 d M47 D20 1951 100 136 Saloon 00/02 - 03/06 5 (E39) 525 d M57 D25 2497 120 163 Saloon 00/02 - 03/06 5 (E39) 530 d M57 D30 2926 135 184 Saloon 98/08 - 00/09 BMW5 Touring (E39) (1997/01 - 2004/05) 5 Touring (E39) 530 d M57 D30 2926 135 184 Estate 98/08 - 00/09 5 Touring (E39) 525 d M57 D25 2497 120 163 Estate 00/02 - 04/05 5 Touring (E39) 520 d M47 D20 1951 100 136 Estate 00/02 - 03/09 5 Touring (E39) 530 d M57 D30 2926 142 193 Estate 00/09 - 04/05 BMW3 (E46) (1998/02 - 2005/04) 3 (E46) 320 d M47 D20 1951 100 136 Saloon 98/04 - 01/09 3 (E46) 330 d M57 D30 2926 135 184 Saloon 99/10 - 05/02 3 (E46) 330 xd M57 D30 2926 135 184 Saloon 00/06 - 05/02 3 (E46) 320 d M47N 204 D4 1995 110 150

Item	OE	Photo	Applicable model
EGR106	LR018323		RANGE ROVER III (LM) 3.0 TD 6 RANGE ROVER SPORT (LS) 2.7 TDVM
EGR107	LR018324 LR009810		DISCOVERY III (TAA) 2.7 TD RANGE ROVER SPORT (LS) 2.7 TDVM
EGR108	14710-00Q0C 44 31 702 96161826 7701209370 H8200222772 408-265-001-018A2C53094175		<p>NISSANINTERSTAR (X70)dCi  100NISSANINTERSTAR (X70)dCi  100NISSANINTERSTAR (X70)dCi  120NISSANINTERSTAR (X70)dCi  120NISSANINTERSTAR (X70)dCi  150NISSANINTERSTAR (X70)dCi  100NISSANINTERSTAR (X70)dCi  100NISSANINTERSTAR (X70)dCi  120NISSANINTERSTAR (X70)dCi  120NISSANINTERSTAR (X70)dCi  150NISSANINTERSTARdCi  100NISSANINTERSTARdCi  120NISSANINTERSTARdCi  120NISSANINTERSTARdCi  150NISSANPRIMASTAR (X83)dCi  140NISSANPRIMASTAR (X83)dCi  115NISSANPRIMASTAR (X83)dCi  150NISSANPRIMASTAR (X83)dCi  140NISSANPRIMASTAR (X83)dCi  115NISSANPRIMASTAR (X83)dCi  150PELMOVANO Combi (J9)2.5  DTIOPELMOVANO Combi (J9)2.5  CDTIOPELMOVANO Combi (J9)2.5  CDTIOPELMOVANO Combi (J9)2.5  CDTIOPELMOVANO (F9)2.5  DTIOPELMOVANO (F9)2.5  DTIOPELMOVANO (F9)2.5  CDTIOPELMOVANO (F9)2.5  CDTIOPELMOVANO (F9)2.5  CDTIOPELMOVANO (F9)2.5  CDTIOPELMOVANO (U9, E9)2.5  DTIOPELMOVANO (U9, E9)2.5  DTIOPELMOVANO (U9, E9)2.5  CDTIOPELMOVANO (U9, E9)2.5  CDTIOPELMOVANO (U9, E9)2.5</p>

Item	OE	Photo	Applicable model
EGR109	8200129863 14 71 053 08R		SCENIC III CLIO III MEGANE III
EGR111	46535796 46778198 555029 72294710 83.655 XEGR53 88006		PALIO (178BX) 1.9 D STRADA (178E) 1.9 D PUNTO (188) 1.9 JTD 80 (188.237, .257, .337, .357) ALBEA (178_) 1.9 D DOBLO (119) 1.9 D (223AXB1A) DOBLO Cargo (223) 1.9 D (223ZXB1A) PUNTO Van (188AX) 1.9 D 60
EGR112	038131501BF 038131501AD 038131501BH 555048 70036500 V10-63-0004 83.630		A4 Avant (8E5, B6) 1.9 TDI A4 Convertible (8H7, B6, 8HE, B7) 2.0 TDI A4 Avant (8ED, B7) 2.0 TDI NEW BEETLE (9C1, 1C1) 1.9 TDI PASSAT (3B3) 2.0 TDI PASSAT Variant (3B6) 2.0 TDI MULTIVAN Mk V TRANSPORTER Mk V Platform/Chassis TRANSPORTER Mk V Box TRANSPORTER / CARAVELLE Mk V Bus SUPERB (3U4) 2.0 TDI
EGR113	074129463A 7223D 83740		TRANSPORTER / CARAVELLE IV Bus (70XB, 70XC, 7DB, 7DW) 2.5 TDI TRANSPORTER IV Box (70XA) 2.5 TDI LT 28-35 II Bus (2DM) 2.5 TDI LT 28-46 II Box (2DX0AE) 2.5 TDI LT 28-46 II Platform/Chassis (2DX0FE) 2.5 TDI
EGR114	8200270177 8200452876 8200550348 8200561269 8200550361 555169 700368050 700368150 XEGR82 83.743		KANGOO (KC0/1_) 1.5 dCi KANGOO (KC0/1_) 1.5 dCi CLIO II (BB0/1/2_, CB0/1/2_) 1.5 dCi KANGOO Express (FC0/1_) 1.5 dCi (FC1G) CLIO II Box (SB0/1/2_) 1.5 dCi SYMBOL (LB0/1/2_) 1.5 dCi MEGANE II (BM0/1_, CM0/1_) 1.5 dCi SCéNIC II (JM0/1_) 1.5 dCi (JM1F) MEGANE II Saloon (LM0/1_) 1.5 dCi LOGAN (LS_) 1.5 dCi (LS0W) LOGAN MCV (KS_) 1.5 dCi (KS0W) SANDERO 1.5 dCi LOGAN EXPRESS (FS_) 1.5 dCi (FS0K)

Item	OE	Photo	Applicable model
EGR116	076131501A 076131501B 555227 700823030 14393 V10630055 710575D 83841		TOUAREG (7LA, 7L6, 7L7) 2.5 R5 TDI MULTIVAN Mk V (7HM, 7HN, 7HF, 7EF, 7EM, 7EN) 2.5 TDI TRANSPORTER Mk V Platform/Chassis (7JD, 7JE, 7JL, 7JY, 7JZ, 2.5 TDI 4motion TRANSPORTER Mk V Box TRANSPORTER / CARAVELLE Mk V Bus CRAFTER 30-35 Bus (2E_) 2.5 TDI CRAFTER 30-50 Box (2E_) 2.5 TDI CRAFTER 30-50 Platform/Chassis (2F_) 2.5 TDI
EGR117	1618 LN AV6Q-9E456-BA 1702178 36001487 7.02209.11.0		
EGR118	6421401760 v30630012 710476D		VIANO (W639) CDI 3.0 VITO Bus (W639) 120 CDI VITO / MIXTO Box (W639) 120 CDI SPRINTER 3-t Box (906) 218 CDI SPRINTER 3-t Platform/Chassis (906) 218 CDI SPRINTER 3,5-t Box (906) 318 CDI SPRINTER 5-t Box (906) 518 CDI SPRINTER 5-t Platform/Chassis (906) 518 CDI
EGR119	5851586 24445720 555041 7.28384.13 7.28384.00 FDR172 83.639 V40-63-0037		ASTRA G Hatchback (F48_, F08_) 1.6 ASTRA G Estate (F35_) 1.6 VECTRA C 1.6 MERIVA 1.6 ZAFIRA (A05) 1.6 ASTRA H TwinTop 1.6 VECTRA Mk II (C) 1.6
EGR120	11717801942 7801942 7518195 88195 7.00684.08 7.00684.10 7.00684.12 7.00684.14 700684080 700684100 700684140 83.922		BMW 5 (E60) 520d BMW X3 (E83) 2.0 d BMW 1 (E81, E87) 120d BMW 3 (E90) 318d Mini Hatchback Mini Convertible Mini Coupe

Item	OE	Photo	Applicable model
EGR121	A6601400360 7.00306.36.0 45-8147 555265 6391400560 7.00306.27 7.00306.32.0 7518211 83.938 V30-63-0027		Smart Fortwo Cabrio Smart Fortwo Coupe
EGR122	55216292 5851089 93195431 55252380 851045 55577947 555223 7518124 7.01599.10 83.827		Fiat Doblo Großraumlimousine Fiat Doblo Kasten/Kombi Fiat Panda Opel Astra J Opel CORSA D 1.3 CDTI Fiat Punto Evo VAUXHALLASTRA Mk VI (J) VAUXHALLMERIVA Mk II (B) MITO (955) 1.3 JTDM MUSA (350) 1.3 D Multijet
EGR123	11717792077 11717804381 7792077 7804381 555228 70051203 7.00512.00 83.919 88192		BMW 1 (E81, E87) BMW 3 (E90) BMW 3 Convertible (E93) BMW 3 Coupe (E92) BMW 3 Touring (E91) BMW 5 (E60) BMW 5 Touring (E61) BMW 7 (E65, E66) BMW X3 (E83) BMW X5 (E70)
EGR124	7804351 11717804351 11717804352 7804352 7518196 7.00450.10 7.00450.08 88196 83.923 V20-63-0008		BMW 3 (E90) 335d BMW 3 Coupe (E92) 335d BMW 3 Touring (E91) 335d BMW X3 (E83) 3.0 sd BMW X6 (E71, E72) xDrive 35 d
EGR125	11717804379 11717789999 7789999 7804379 728264070 555230 72826407 7.28264.02 83.921 88194 7518194		BMW 3 (E46) 330 d BMW 3 Coupe (E46) 330 Cd BMW 3 3 Touring (E46) 330 d BMW 3 Convertible (E46) 330 Cd BMW 7 (E65, E66) 730 d BMW X5 (E53) 3.0 d BMW 5 Touring (E61) 530 d

Item	OE	Photo	Applicable model
EGR126	11712244900 11712246145 11712247177 11712248139 7.21920.62.0 7.21920.00.0 7.21920.10.0 7.21920.11.0 7.21920.12.0 7.21920.50.0 7.21920.61.0 5851014 851649 90509132 90541691		BMW 3 (E361 325 td BMW 5 (E34) 525 td BMW 5 (E39) 525 tds BMW 5 Touring (E34) 525 td BMW 5 Touring (E39) 525 tds BMW 7 (E38) 725 tds OPEL OMEGA B (25_, 26_, 27J 2.5 TD OPEL OMEGA B Estate (21_, 22_, 23J 2.5 TD VAUXHALL OMEGA (B) 2.5 TD
EGR127	83920 7804378 7785452 11717804378 11717785452 728264060 LR005791 WAV000040		BMW 3 Series BMW 5 Series BMW 7 Series Land Rover Freelander Land Rover Freelander 2
EGR128	1717793484 11717804380 11717804382 7793484 7804380 7804382 70045002 V20-63-0011 83.918 7518191 88191		BMW 1 (E87) 118 d BMW 3 (E90) 318 d BMW 3 (E90) 325 d BMW 5 (E60) 520 d BMW 5 Touring (E61) 520 d BMW 7 (E65, E66, E67) 730 Ld BMW X3 (E83) 2.0 d BMW X5 (E53) 3.0 d BMW X5 (E70) 3.0 sd
EGR130	8200411031 8200507299 8200609274 8200630740 8200796571 408-265-001-010Z		RENAULT LAGUNA, MEGANE, SCÉNIC
EGR131	A2C53217899 H8200987088 8200796674 14710-00Q0Y		RENAULT KOLEOS (HY_) 2.0 dCi RENAULT LAGUNA III (BT0/1) 2.0 dCi RENAULT TRAFIC II Bus RENAULT MEGANE III Coupe RENAULT TRAFIC Box RENAULT TRAFIC II Platform/Chassis



Item	OE	Photo	Applicable model
EGR132	V46-63-0001 7.00075.07.0 7.701058.85.0 8200542999 8200467059 8200463548 7701065038 7701067308		RENAULT
EGR133	V51-63-0001 25 182 357		
EGR134	V25-63-0001 1 682 737		
EGR135	12565309 12565309 12573722 12581876 12613270 24508966 214-2098 EGV612T		Chevrolet Equinox Pontiac Torrent Buick Rendezvous Buick Terraza Chevrolet Malibu Chevrolet Uplander Pontiac G6 Buick Century Pontiac Aztek
EGR136	030131547B 030131550 030131503F		VW Polo Polo Classic Polo Variant Seat Arosa VW Lupo

Item	OE	Photo	Applicable model
EGR137	96253548		DAEWOO MATIZ CHEVROLET
EGR138	AEGR-947 555258 14710 DB001 14710 DB002 22310 00QAA 44 15 143 44 16 427 93180002 93187484 7701058063 7701063353 408-265-001-011Z 408-265-001-011 A2C53027341		NISSAN INTERSTAR Box (X70) dCi 140 NISSAN INTERSTAR Platform/Chassis dCi 140 OPEL MOVANO Box (F9) 3.0 DTI OPEL MOVANO Combi (J9) 3.0 DTi RENAULT MASTER II Box (FD) RENAULT MASTER II Bus (JD) RENAULT TRUCKS MASCOTT Box BodyVAUXHALL MOVANO Mk I (A) Van (FD) 3.0 DTI
EGR139	038131501AG 038131501BB 038131501C 7.22477.10.0 83.716 710570D XEGR55		SEAT AROSA (6H) 1.4 TDI SEAT AROSA (6H) 1.7 SDI SEAT CORDOBA (6K2) 1.9 SDI SKODA FABIA (6Y2) 1.9 SDI SKODA OCTAVIA (1U2) 1.9 SDI VW BORA (1J2) 1.9 SDI VW CADDY II Box (9K9A) 1.9 SDI VW GOLF IV (1J1) 1.9 SDI VW LUPO (6X1, 6E1) 1.7 SDI VW POLO (6N1) 60 1.7 SDI VW POLO Saloon (6KV2) 57 1.7 SDI
EGR140	7.22477.11.0 7.22477.05.0 7.24809.18.0 7.22477.09.0 038131501AH 038131501BC V10-63-0044 555145 83.717		VW CADDY III Box (2KA, 2KH, 2CA, 2CH) 2.0 SDI VW CADDY III Estate (2KB, 2KJ) 2.0 SDI VW GOLF V(1K1) 2.0 SDI
EGR141	1C1Q9D475AC 1120698 7.28146.00.0 XEGR67		Ford Transit Box 2.0 Di Ford Transit Bus 2.0 Di Ford Transit Platform/Chassis 2.0 Di

Item	OE	Photo	Applicable model
EGR142	038131501 72247700		VW Caddy II Kasten
EGR143	059131502B 7.02132.02.0 702132070 7518214 83.941 V10-63-0059 88214		Audi A4 2.7 TDI Audi A4 Allroad Audi A5 Coupe 2.7 TDI Audi A5 Hatchback 2.7 TDI Audi A5 Convertible 2.7 TDI Audi A6 Saloon 2.7 TDI Audi A6 Estate 2.7 TDI AUDI Q5 (8R) 3.0 TDI quattro AUDI Q7 (4L) 3.0 TDI VW TOUAREG (7LA, 7L6, 7L7) 3.0 V6 TDI VW TOUAREG (7P5) 3.0 V6 TDI
EGR144	045131501D 83747 7301D 7.24809.57.0 555084 ERV058 7518097 045131501		Audi A2 Hatchback 1.4 TDI VW Lupo Hatchback 1.4 TDI
EGR145	7.22772.11.0 45-8191 555181 7.22772.09 7.22772.11 7518105 83.812 860441 88105 897353973Y 97353973 V40-63-0031		Opel Corsa C Box 1.7 Di 16V Opel Corsa C Hatchback 1.7 Di Vauxhall Corsavan Box 1.7 Di 16V Vauxhall Corsa Hatchback 1.7 Di 16V

Item	OE	Photo	Applicable model
EGR146	555185, 7518106, 8971849255, 8980919250, 88106, 851151, 97318476, 7.22772.03, 7.22772.04, 7.22772.10, 7.22772.12, 72277203, 722772030, 72277204, 722772040, 72277210, 722772100, 72277212, 722772120, 83.813, V40.63.0029		OPEL ASTRA G hatchback (F48_, F08_) 1.7 DTI 16V OPEL ASTRA G kombi (F35_) 1.7 DTI 16V OPEL ASTRA G sedan (F69_) 1.7 DTI 16V OPEL CORSA C (F08, F68) 1.7 DI OPEL CORSA C (F08, F68) 1.7 DTI OPEL CORSA C (F08, W5L) 1.7 DI 16V OPEL CORSA C (F08, W5L) 1.7 DTI 16V
EGR147	25800-26010 DEG-0104 150100-0040 150100-0041 150100-0042 150100-0070 150100-0071 150100-0072 150100-0073 25800-0R010		TOYOTA AURIS TOYOTA AVENSIS Estate TOYOTA RAV 4 III Toyota Verso
EGR148	DEG0102 150100-0030 150100-0031 150100-0032 150100-0033 25800-33010 25800-33011		TOYOTA AURIS (NRE15_, ZZE15_, ADE15_, ZRE15_, NDE15_) 1.4 D-4D TOYOTA AURIS (NZE18_, ZRE18_) 1.4 D-4D TOYOTA COROLLA sedan (E15_) 1.4 D-4D TOYOTA IQ (KGJ1_, NGJ1_) 1.4 D-4D TOYOTA URBAN CRUISER (NSP1_, NLP1_, ZSP1_, NCP11_) 1.4 D-4D TOYOTA URBAN CRUISER (NSP1_, NLP1_, ZSP1_, NCP11_) 1.4 D-4D 4WD TOYOTA VERSO S (NLP12_, NCP12_, NSP12_) 1.4 D-4D TOYOTA YARIS (NLP13_, NSP13_, NCP13_, KSP13_) 1.4 D-4D TOYOTA YARIS (SCP9_, NSP9_, KSP9_, NCP9_, ZSP9_) 1.4 D-4D
EGR149	EGV558 911-608 25620-74330		Toyota Camry Toyota Solara Toyota Celica Toyota RAV4

Item	OE	Photo	Applicable model
EGR150	2841027410 V52630004 EGR212		HYUNDAI SANTA Fé II (CM) 2.2 CRDi HYUNDAI i30 (FD) 2.0 CRDi KIA CARENS II (FJ) 2.0 CRDi KIA CEE'D SW (ED) 2.0 CRDi 140 KIA SPORTAGE (JE_) 2.0 CRDi
EGR151	284102A120		HYUNDAI ACCENT III (MC) 1.5 CRDi GLS HYUNDAI GETZ (TB) 1.5 CRDi HYUNDAI i10 (PA) 1.1 CRDi HYUNDAI i30 CW (FD) 1.6 CRDi HYUNDAI i30 (FD) 1.6 CRDi KIA CEE'D Hatchback (ED) 1.6 CRDi 115 KIA CEE'D Hatchback (ED) 1.6 CRDi 90 KIA PICANTO (BA) 1.1 CRDi KIA RIO II (JB) 1.5 CRDi
EGR152	2841027400 V52-63-0003		HYUNDAI SANTA HYUNDAI SONATA V (NF) 2.0 CRDi HYUNDAI i30 (FD) 2.0 CRDi KIA CARENS II (FJ) 2.0 CRDi KIA CEE'D SW (ED) 2.0 CRDi 140 KIA MAGENTIS (MG) 2.0 CRDi KIA PRO CEE'D (ED) 2.0 CRDi 140 KIA SPORTAGE (JE_) 2.0 CRDi
EGR153	EGR4198 4F1394 91017 1902-306213 EGV959		Kia Magentis Kia Optima
EGR154	284104A410 555125B 83.793		KIA SORENTO I (JC) 2.5 CRDi





Item	OE	Photo	Applicable model
EGR155	284104A100 555215 83896		HYUNDAI H-1 / GRAND STAREX Bus (TQ) 2.5 CRDi HYUNDAI H-1 Box 2.5 CRDi HYUNDAI H300 Box (TQ) 2.5 CRDi KIA SORENTO I (JC) 2.5 CRDi
EGR156	28410-4A470		HYUNDAI H300 Box (TQ) 2.5 CRDi
EGR157	28410-2A350		HYUNDAI i20 (PB, PBT) 1.6 CRDi Kia Cee'D Hatchback 1.6 CRDi 115 Kia Pro Cee'D Hatchback 1.6 CRDi 115 Kia Soul Hatchback 1.6 CRDi 115 Kia Venga Hatchback 1.6 CRDi 115
EGR158	284102A100		HYUNDAI MATRIX (FC) 1.5 CRDi HYUNDAI MATRIX (FC) 1.5 CRDi VGT
EGR159	2841027250 555095 83786 88133		Hyundai Getz Hyundai Tucson KIA Sportage

Item	OE	Photo	Applicable model
EGR160	18011-PWA-010 18011-PWA-030 18011-PWA-040 18011-PWA-000 18011-PWA-050		HONDA
EGR161	12581515 18011P8AA00 18011P8CA00 18011P8FA00 18011PGKA00 18011PGKA02 18011PGKA03 18011RCAA00 EGV658T		ACURA HONDA SATURN
EGR162	18011PGKA03 ENP2881		Honda Odyssey Honda Pilot
EGR163	18011PAAA00 5862060090 EGV980		ACURA HONDA ISUZU
EGR164	EGV576 18011PLMA00 18011PLMA01		Honda Civic

Item	OE	Photo	Applicable model
EGR165	18011P2MA00 2-26641 EGV982 EGR4053 EGR1741 1902-305720 70-5932		Honda Civic GX Sedan 4-Door Honda Civic HX Coupe 2-Door Honda Civic GX Sedan 4-Door Honda Civic HX Coupe 2-Door
EGR166	EGR4507 4F2057 70-6338		Honda Fit Base Hatchback 4-Door Honda Fit DX Hatchback 4-Door Honda Fit LX Hatchback 4-Door Honda Fit Sport Hatchback 4-Door Honda Fit Base Hatchback 4-Door Honda Fit DX Hatchback 4-Door Honda Fit LX Hatchback 4-Door Honda Fit Sport Hatchback 4-Door Honda Fit Sport Hatchback 4-Door Honda Fit Base Hatchback 4-Door
EGR167	EGV1132 EGR4196 70-6054 4F1368		Honda Insight Base Hatchback 3-Door
EGR168	25800-30200		
EGR170	724809630 07Z131501A 555081 7.24809.63 83.856 V10-63-0035 7268D 88121		VW PHAETON (3D_) 5.0 V10 TDI 4motion VW TOUAREG (7LA, 7L6, 7L7) 5.0 V10 TDI











Item	OE	Photo	Applicable model
EGR171	074129637C 7187D		VW Transporter IV Bus VW Transporter IV Kasten VW Transporter IV Pritsche/Fahrgestell
EGR172	03L131501F 03L13 501 7518248 70149307 70149306 88248 83.988		VW BEETLE (5C1) 2.0 TDI VW BEETLE Convertible (5C7) 2.0 TDI VW GOLF VI (5K1) 2.0 TDI VW GOLF VI Variant (AJ5) 2.0 TDI 16V VW JETTA IV (162) 2.0 TDI
EGR173	03L131477 03L131501H 03L131501Q 7.03196.10 7049542607 7.03196.09.0		VW MULTIVAN Mk V (7HM, 7HN, 7HF, 7EF, 7EM, 7EN) 2.0 BiTDI VW TRANSPORTER V Box (7HA, 7HH, 7EA, 7EH) 2.0 BiTDI VW TRANSPORTER V Bus (7HB, 7HJ, 7EB, 7EJ, 7EF) 2.0 BiTDI VW TRANSPORTER V Platform/Chassis (7JD, 7JE, 7JL, 7JY, 7JZ, 7FD) 2.0 BiTDI
EGR174	700407 1148077 1628XV 2S6Q9D475AA 2S6Q9D475AB 1483814 555010 FDR171 724809060		CITROEN C2 (JM_) 1.4 HdI CITROEN C3 I (FC_) 1.4 16V HDi CITROEN XSARA (N1) 1.4 HDi FORD FIESTA V (JH_, JD_) 1.4 TDCi FORD FUSION (JU_) 1.4 TDCi PEUGEOT 1007 (KM_) 1.4 HDi PEUGEOT 206 Hatchback (2A/C) 1.4 HDi eco 70 PEUGEOT 307 (3A/C) 1.4 HDi





Item	OE	Photo	Applicable model
EGR175	1628JZ 9635651080 1618Q0 700405 555005 88078 V42630004 700405 7518078		CITROEN BERLINGO (MF) 2.0 HDI 90 (MFRHY) CITROEN C5 I (DC_) 2.0 HDi CITROEN EVASION (22, U6) 2.0 HDI CITROEN JUMPY (U6U) 2.0 HDi 110 CITROEN XSARA (N1) 2.0 HDi 109 FIAT SCUDO Box (220L) 2.0 JTD PEUGEOT 206 Hatchback (2A/C) 2.0 HDI 90 PEUGEOT 307 Estate (3E) 2.0 HDI 90 PEUGEOT 406 (8B) 2.0 HDI 90 PEUGEOT EXPERT (224) 2.0 HDI
EGR176	162642 504121701 04008160095 7631D		CITROEN JUMPER Box 3.0 HDi 160 FIAT DUCATO Box (250) 160 Multijet 3,0 D IVECO DAILY IV Box Body / Estate 35C15 V, 35C15 V/P IVECO MASSIF Pickup 3.0 HPI MULTICAR Fumo 3,0 PEUGEOT BOXER Box 3.0 HDi PEUGEOT BOXER Platform/Chassis 3.0 HDi
EGR177	1628WV 9640341280 700406 555008 ERV040 88079		CITROEN JUMPER Box (230L) 2.0 HDI FIAT DUCATO Box (230L) 2.0 JTD PEUGEOT BOXER Box (230L) 2.0 HDI PEUGEOT BOXER Platform/Chassis (244) 2.0 HDi
EGR178	1628CF 700404 9630651780 555003 2580027A		CITROEN BERLINGO (MF) 1.9 D (MFDJY) CITROEN JUMPER Box (230L) 1.9 D CITROEN XSARA (N1) 1.9 D CITROEN XSARA Coupe (N0) 1.9 D CITROEN XSARA Estate (N2) 1.9 D PEUGEOT 306 (7B, N3, N5) 1.9 SLD PEUGEOT BOXER Box (230L) 1.9 D PEUGEOT PARTNER Combispace (5F) 1.9 D
EGR179	16287T 9619452580 700401 555004 2580018A 71788530		CITROEN EVASION (22, U6) 1.9 TD CITROEN JUMPY (U6U) 1.9 TD CITROEN XANTIA (X1) 1.9 Turbo D CITROEN XANTIA Estate (X1) 1.9 Turbo D FIAT SCUDO Box (220L) 1.9 TD FIAT ULYSSE (220) 1.9 TD (220AH5) PEUGEOT 406 (8B) 1.9 TD PEUGEOT EXPERT (224) 1.9 TD

Item	OE	Photo	Applicable model
EGR180	96 38246980 1628 NN 555200 72288802 722888010 XEGR44 88109 83.816		CITROEN C5 I (DC_) 2.2 HDi (DC4HXB, DC4HXE) CITROEN C5 II (RC_) 2.2 HDi (RC4HXE) PEUGEOT 406 (8B) 2.2 HDi PEUGEOT 406 Coupe (8C) 2.2 HDi PEUGEOT 607 (9D, 9U) 2.2 HDi
EGR181	722843070 1628VT, 45-8154, 555206, 7.22843.02, 7.22843.02.0, 7.22843.07, 72284302, 722843020, 72284307, 722843070, 7518120, 83.825, 88120, FDR254, V42-63- 0001 XEGR41		Citröen C5 Peugeot 307 Peugeot 307 SW Peugeot 406 Peugeot 607
EGR182	71793031 504150396		FIAT
EGR183	A2C59515075 504373660 A2C53374117		FIAT DUCATO Box (244) 2.8 JTD Power FIAT DUCATO Platform/Chassis (244) 2.8 JTD Power
EGR186	8973586130 8980607961 97358613 98060796 851749		ISUZU OPEL

Item	OE	Photo	Applicable model
EGR187	0021402660 V30-63-0009 WA7159D		Mercedes-Benz G-Class Mercedes-Benz Sprinter MERCEDES-BENZ UNIMOG MERCEDES-BENZ VITO (638) MERCEDES-BENZ VARIO MERCEDES-BENZ KLASA G (W461)
EGR188	9802194080 702209140		Peugeot Partner Tepee
EGR189	RE537143		John Deere
EGR190	25620-27090 135000-8110 DEG-0101 555301 83964 83964		TOYOTA AVENSIS (T25_) 2.0 D-4D TOYOTA AXIO/ALTIS Saloon (_E12J_, _E12T_) 2.0 D-4D TOYOTA COROLLA Combi (_E12J_, _E12T_) 2.0 D-4D TOYOTA RUNX (ZZE12_, NDE12_, ZDE12_) 2.0 D-4D TOYOTA COROLLA Verso (ZER_, ZZE_, R1_) 2.0 D-4D
EGR191	25620-27100 135000-7110 135000-7111 DEG0106 83969 555303		TOYOTA AVENSIS (T25_) 2.0 D-4D TOYOTA AVENSIS Combi (T25) 2.0 D-4D TOYOTA AVENSIS Saloon (T25) 2.0 D-4D

Item	OE	Photo	Applicable model
EGR192	25620-33030 135000-8120 555239 1350008120 DEG0100 83966		TOYOTA AURIS (NRE15_, ZZE15_, ADE15_, ZRE15_, NDE15_) 1.4 D-4D TOYOTA AXIO/ALTIS Saloon (_E12J_, _E12T_) 1.4 D-4D TOYOTA COROLLA Combi (_E12J_, _E12T_) 1.4 D4-D TOYOTA COROLLA Saloon (E15_) 1.4 D-4D TOYOTA RUNX (ZZE12_, NDE12_, ZDE12_) 1.4 D TOYOTA YARIS/VITZ (SCP9_, NSP9_, KSP9_, NCP9_, ZSP9_) 1.4 D-4D
EGR193	25620-27080 1350008090 555302 83968 DEG0105		TOYOTA ESTIMA (MCR3_, ACR3_, CLR3_) 2.0 D-4D TOYOTA PICNIC (_CLM2_, _ACM2_) 2.0 D-4D TOYOTA RAV 4 Mk II (CLA2_, XA2_, ZCA2_, ACA2_) 2.0 D-4D 4WD
EGR194	25620-26110 25620-0R021 25620-0R011 25620-0R020 25620-26091 135000-7140 135000-7201 135000-7161 717720044 135000-7141		TOYOTA AURIS TOYOTA AVENSIS (T25_) 2.0 D-4D TOYOTA COROLLA Verso (ZER_, ZZE_, R1_) 2.2 D-4D TOYOTA PICNIC (_CLM2_, _ACM2_) 2.2 D-4D TOYOTA RAV 4 III (ACA3_, ACE_, ALA3_, GSA3_, ZSA3_) 2.2 D-4D
EGR195	25620 37120		Toyota Prius Lexus CT200h Toyota Prius Toyota Prius V
EGR196	25620-26092		TOYOTA

Item	OE	Photo	Applicable model
EGR197	25620-0R022		TOYOTA
EGR200	646 142 00 19 646 142 01 19 647 142 00 19 647 142 02 19 7610D		MERCEDES-BENZ
EGR201	6461400460 6461400760 7389D		MERCEDES-BENZ
EGR202	6461400860 A6461400860 7353D		MERCEDES-BENZ
EGR203	03G131501E 7529D		VAG VW





Item	OE	Photo	Applicable model
EGR204	6421400160 6421400360 6421400860 7527D		MERCEDES-BENZ
EGR205	03L131512CH 03L131512AT 03L131512BJ 03L131512BL 03L131512N 03L131512DQ 03L131512AP 03L131512BB 03L131512CF		VW
EGR206	11 71 7 810 871 710327D		BMW 1 3 5 X1 X3 X4 X5 X6 SERIES E60N E70N E71 E81 E83N E84 E87N E90N
EGR207	710471D 6421401460		MERCEDES-BENZ G-CLASS (W461) G 280 CDI MERCEDES-BENZ SPRINTER 3,5 MERCEDES-BENZ SPRINTER 3-t MERCEDES-BENZ SPRINTER 4,6-t MERCEDES-BENZ SPRINTER 5-t
EGR208	074 129 499 B		



Item	OE	Photo	Applicable model
EGR209	059131501C 059131501D 059131501H 7.01782.06 701782070 701782020 88250		AUDI A4 (8K2, B8) 2.7 TDI AUDI A4 (8K2, B8) 3.0 TDI quattro AUDI A5 (8T3) 2.7 TDI AUDI A5 (8T3) 3.0 TDI quattro AUDI Q7 (4L) 3.0 TDI VW PHAETON (3D_) 3.0 V6 TDI 4motion VW TOUAREG (7LA, 7L6, 7L7) 3.0 V6 TDI
EGR210	8C3Z9D475B 8C3Z9D475C 8C3Z9D475D 8C3Z9E461A CX2366 9C3Z9D475A		Ford F-250 Super Duty Ford F-350 Super Duty Ford F-450 Super Duty Ford F-550 Super Duty
EGR211	82 00 846 454 7.00368.16.0		
EGR213	629 140 06 60 629 140 08 60 629 140 15 60 7556D		
EGR214	629 140 05 60 629 140 07 60 629 140 12 60 7557D		

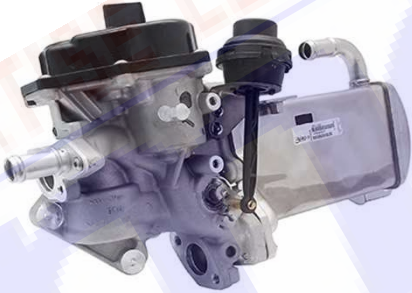

Item	OE	Photo	Applicable model
EGR215	651 140 00 60 651 140 01 60 651 140 06 60 A651 140 00 60 A651 140 01 60 A651 140 06 60 651 140 08 60 A651 140 08 60 A2C59514268		
EGR216	640 140 19 60 710073D	 <p>710073D</p>	
EGR217	642 140 04 60 642 140 18 60 7645D	 <p>7645D</p>	
EGR218	642 140 17 60 710476D		
EGR219	628 142 01 19 7396D		

Item	OE	Photo	Applicable model
EGR220	646 140 09 60 646 140 19 60 646 140 24 60 646 140 27 60 710023D		
EGR221	646 140 17 60 646 140 23 60 7625D		
EGR222	612 098 04 17 7256D		
EGR223	640 140 07 60 640 140 14 60 640 140 18 60		
EGR224	11 71 7 563 241 7574D		

Item	OE	Photo	Applicable model
EGR225	03L131512AQ 03L131512BN 03L131512DL 700439		
EGR226	03L131512BM 03L131512DS 700435		
EGR227	03L131512DN 03L131512BQ 03L 131 512 BG 03L 131 512 CD		
EGR228	03L131512AR 03L131512BP 03L131512DJ 03L131512DM		
EGR229	1618PS 9676936180 9678163380		

Item	OE	Photo	Applicable model
EGR230	1618KL 1618NQ 1682007 1836229 9M5Q9D475CA 700434		
EGR231	147106293R 8200762517 8201027384 700433		

EXPERTISE LEAD EXCELLENCE

TEMCO