



OIL PRESSURE SWITCH



P

01

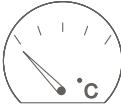

WATER TEMP. SWITCH



W

02



THERMO SWITCH



T

03

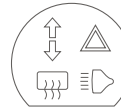

SWITCH SERIES



S

04



OIL PRESSURE SENSOR



Y

05

Odometer Sensors



L

06

Air Pressure Sensors



J

07



01-P011001

OEM NO.

Application List

	Benz 004 542 5917		PRESSURE 0.40bar	
	Facet 7.0074			

Mercedes Benz

100D
Classe G 230 G
Classe G 240 GD
Classe G 280 GE
Classe G 300 GD
T1 207D
T1 209D
T1 210
T1 307D
T1 309D
T1 407D
T1 409D
T1 410

01

01-P011002

OEM NO.

Application List

	Benz 001 542 3817		PRESSURE 0.40bar	
	Daf 0082445			

Mercedes Benz

MB 100
MB 120
MB 140
MB 160
Motores/Engines615

AUDI

60.72.75.Variant
90
100

PORSCHE

911
912

DAF

Camiones/Trucks
615.825
Motores/Engines 1160

MAN

Camiones/Trucks

SKODA

S100
S110

01-P011101

OEM NO.

Application List

	Bmw 12 611 277 642		PRESSURE 0.30bar	

BMW

316i
320i
323i
518
520i
525E
525i
528i

01-P011102

OEM NO.

Application List

	Bmw 61 311 351 799	Facet 7.0007		PRESSURE 0.40bar	
	Audi-Vw 021 919 081A,8 111 919 081A 113 919 081				
	Mercedes 000 545 43 17 Alfa Romeo 60506902 60593846 60595694 Rover Group NUC 1007 Skoda 115-094-200				

BMW

AUDI

50
80
90
100

MERCEDES BENZ

Motores/Engines OM-636

ROVER

825

ALFA ROMEO

Alfa 33
Alfa 75
Alfa 90
Alfa 155
Alfa 164
Alfa 166
Alfetta.Giulia.Giulietta
GTV
Spider

SKODA

105,120,Estelle,Rapid
Favorit.136 Coupe
VOLKSWAGEN
Escarabajo/Kafer/Beetle
Dasher.Rabbit
Golf/Jetta/Scirocco
Passat/Santana
Transporter Type2

01-P011103

OEM NO.

Application List

	Bmw 12 611 710 509		PRESSURE 0.35bar	
	Land Rover 1730160			
	Opel 12 52 569			

BMW

316i
318i
318is
318TDS
320i
320ic
323i
324D,TD
325i
325E
325TD,TDS
328i
518i
523i

BMW

524TD
530i
728i
730i
735i,IL
M 3
M5,M535i

01-P011104

OEM NO.

Application List

	Bmw 61 311 354 272		PRESSURE 0.40bar	
	Fiat 4151243 4459908 4151564 4473333			
	Seat CA-942000.04 EA-942000.04 HB-942000.30 SE-020942000A			

BMW

315
316
318
320
320i
323i
320i
325E
325i
518
518i
520
520i
525

BMW

528
525E
525i
530i
535i
1502,1600
1800,2000
M5
M535i
Secie 700

FIAT

126
127
500
525i
850
1100,1200,1300,1500
1600,1800,2100,2300
Panda
UNO 45 903

FIAT

600,800,850,127C
CL,CLX,LS,N127Fura
133
1500B
Ibiza903cc
Marbella850-903cc
Panda,Panda Trans
Terra903cc

FIAT COMM.IVECO

Camiones/Trucks
Fiorino903cc
850T 900T







01

01-P011105

OEM NO.





Application List

	Benz 12 611 277 591 005 542 9017 5508.282 5460.577	BMW	
		3(E30)324D 5(E28)524D 5(E28)524TD	
 M12x1.5		PRESSURE 0.50bar	 M4

01-P011201

OEM NO.

Application List





	Vw-Audi-Seat 056 919 081E Ford 1 669964 95VW-9278-CA	AUDI	
	Facet 7.0045	80 90 100 A3 A4 A6	FORD Galaxy
 M10x1.0		PRESSURE 0.90bar	 6.35 mm

AUDI	FORD	VOLKSWAGEN	V W COMM.
80 90 100 A3 A4 A6	Galaxy	Golf Jetta Passat Polo Vento	Caddy Caravelle LT Transporter
SEAT			
Alhambra Cordoba Ibiza Inca Terra Toledo			

01-P011202

OEM NO.

Application List





	Vw-Seat 056 919 081C 056 919 081B Porsche 911 606 230 00 911 613 571 01 Volvo 1257137 1257137-8	AUDI	
	Facet 7.0008	80 90 100 200 Coupe Fox Quattro V8 4000.5000	VOLKSWAGEN Corrado Derby Golf Jetta Passat/Santana Passat Polo,Claddic,Coupe Quantum Rabbit Scirocco Vento
 M10x1.0		PRESSURE 0.40bar	 6.35 mm

AUDI	VOLKSWAGEN	VW COMM.	VOLVO
80 90 100 200 Coupe Fox Quattro V8 4000.5000	Corrado Derby Golf Jetta Passat/Santana Passat Polo,Claddic,Coupe Quantum Rabbit Scirocco Vento	Bus Caddy Caravelle Golf van LT28,31,35,40,45 LT2.4 Transporter Type2 Transporter Vanagon	Series 240,D24 Series 240 Diesel Series 260 Diesel 740 760 780 940
SEAT			
Cordoba Terra 1300D,1400D Ibiza Toledo			

01-P011203

OEM NO.

Application List





	Vw-Seat-Audi 068 919 081 Ford 1 669989 Mercedes 013 542 05 17	AUDI	
	Facet 7.0046	80 90 A3 A4 A6 S4 S6	SEAT Cordoba Ibiza Toledo
 M10x1.0		PRESSURE 1.40bar	 6.35 mm

AUDI	SEAT	VOLKSWAGEN
80 90 A3 A4 A6 S4 S6	Cordoba Ibiza Toledo	Caddy Corrado Derby Golf LT Passat/Santana Polo,Classic,Coupe Quantum Rabbit Scirocco Transporter Type2 Vento

01-P011204

OEM NO.

Application List





	Vw 021 919 081A,B 028 919 081A,B 059 919 081 113 919 081 311 919 081A 061 919 081 Skoda 110 094 203 115 094 200 Porsche 901 613 571 01 Rover GPS 137	AUDI	
	Facet 7.0007 7.0010	A3 A4 A6 A8	FORD Galaxy
 M10x1.0		PRESSURE 0.25bar	 6.35 mm

AUDI	FORD	SEAT	VW
A3 A4 A6 A8	Galaxy	Alhambra Cordoba Ibiza Inca Marbella Terra 1400Diesel Toledo	Corrado Golf Passat Polo Vento

01-P011205

OEM NO.

Application List

	Vw-Audi-Seat 056 919 081E	AUDI	
		80 80except Diesel,V6 90 100 200 A4 A4 A8 Coupe Quattro Rs2 S6.4i V8 32V V8 4000,5000	SEAT Alhambra Cordoba Ibiza Inca Terra Toledo
 M10x1.0		PRESSURE 1.80bar	 6.35 mm

AUDI	SEAT	VW	VW COMM.
80 80except Diesel,V6 90 100 200 A4 A4 A8 Coupe Quattro Rs2 S6.4i V8 32V V8 4000,5000	Alhambra Cordoba Ibiza Inca Terra Toledo	Corrado Derby Golf/Jetta/Scirocco Passat/Santana Passat Polo,Classic,Coupe Vento	Caddy Caravelle Golf Van LT Transporter Type2 Vanagon



01-P011206

OEM NO.

Application List

	Vw-Seat 038 919 081 038 919 081C	<table border="1"> <tr> <th>SEAT</th> <th>VW</th> </tr> <tr> <td>Arosa Alhambra Cordoba Inca Leon Toledo</td> <td>Bora Golf IV Lupo New Beetle</td> </tr> </table>	SEAT	VW	Arosa Alhambra Cordoba Inca Leon Toledo	Bora Golf IV Lupo New Beetle
	SEAT		VW			
Arosa Alhambra Cordoba Inca Leon Toledo	Bora Golf IV Lupo New Beetle					
Ford 1108 808 1206 977 1M21-9278-AA						
		<table border="1"> <tr> <th>SEAT</th> <th>VW</th> </tr> <tr> <td>Arosa Alhambra Cordoba Inca Leon Toledo</td> <td>Bora Golf IV Lupo New Beetle</td> </tr> </table>	SEAT	VW	Arosa Alhambra Cordoba Inca Leon Toledo	Bora Golf IV Lupo New Beetle
SEAT	VW					
Arosa Alhambra Cordoba Inca Leon Toledo	Bora Golf IV Lupo New Beetle					
		<table border="1"> <tr> <th>SEAT</th> <th>VW</th> </tr> <tr> <td>Arosa Alhambra Cordoba Inca Leon Toledo</td> <td>Bora Golf IV Lupo New Beetle</td> </tr> </table>	SEAT	VW	Arosa Alhambra Cordoba Inca Leon Toledo	Bora Golf IV Lupo New Beetle
SEAT	VW					
Arosa Alhambra Cordoba Inca Leon Toledo	Bora Golf IV Lupo New Beetle					

01

01-P011207

OEM NO.

Application List

	Vw-Seat-Audi 038 919 081B 06A 919 081B	<table border="1"> <tr> <th>AUDI</th> <th>SEAT</th> <th>SKODA</th> <th>VW</th> </tr> <tr> <td>A4 A6 A8 Cabriolet S8</td> <td>Ibiza Toledo</td> <td>Super B</td> <td>Bora Golf Passat Polo</td> </tr> </table>	AUDI	SEAT	SKODA	VW	A4 A6 A8 Cabriolet S8	Ibiza Toledo	Super B	Bora Golf Passat Polo
	AUDI		SEAT	SKODA	VW					
A4 A6 A8 Cabriolet S8	Ibiza Toledo	Super B	Bora Golf Passat Polo							
Ford 1 100 767 1 224 914										
		<table border="1"> <tr> <th>AUDI</th> <th>SEAT</th> <th>SKODA</th> <th>VW</th> </tr> <tr> <td>A4 A6 A8 Cabriolet S8</td> <td>Ibiza Toledo</td> <td>Super B</td> <td>Bora Golf Passat Polo</td> </tr> </table>	AUDI	SEAT	SKODA	VW	A4 A6 A8 Cabriolet S8	Ibiza Toledo	Super B	Bora Golf Passat Polo
AUDI	SEAT	SKODA	VW							
A4 A6 A8 Cabriolet S8	Ibiza Toledo	Super B	Bora Golf Passat Polo							
		<table border="1"> <tr> <th>AUDI</th> <th>SEAT</th> <th>SKODA</th> <th>VW</th> </tr> <tr> <td>A4 A6 A8 Cabriolet S8</td> <td>Ibiza Toledo</td> <td>Super B</td> <td>Bora Golf Passat Polo</td> </tr> </table>	AUDI	SEAT	SKODA	VW	A4 A6 A8 Cabriolet S8	Ibiza Toledo	Super B	Bora Golf Passat Polo
AUDI	SEAT	SKODA	VW							
A4 A6 A8 Cabriolet S8	Ibiza Toledo	Super B	Bora Golf Passat Polo							

01-P011208

OEM NO.

Application List

	Vw-Seat 06A 919 081A 06A 919 081D 06A 919 081E	<table border="1"> <tr> <th>AUDI</th> <th>SEAT</th> <th>VW</th> </tr> <tr> <td>A3</td> <td>Arosa Alhambra Cordoba Leon Toledo</td> <td>Bora Golf New Beetle</td> </tr> </table>	AUDI	SEAT	VW	A3	Arosa Alhambra Cordoba Leon Toledo	Bora Golf New Beetle
	AUDI		SEAT	VW				
A3	Arosa Alhambra Cordoba Leon Toledo	Bora Golf New Beetle						
Ford 1 094 739 95VW-9278-EA								
		<table border="1"> <tr> <th>AUDI</th> <th>SEAT</th> <th>VW</th> </tr> <tr> <td>A3</td> <td>Arosa Alhambra Cordoba Leon Toledo</td> <td>Bora Golf New Beetle</td> </tr> </table>	AUDI	SEAT	VW	A3	Arosa Alhambra Cordoba Leon Toledo	Bora Golf New Beetle
AUDI	SEAT	VW						
A3	Arosa Alhambra Cordoba Leon Toledo	Bora Golf New Beetle						
		<table border="1"> <tr> <th>AUDI</th> <th>SEAT</th> <th>VW</th> </tr> <tr> <td>A3</td> <td>Arosa Alhambra Cordoba Leon Toledo</td> <td>Bora Golf New Beetle</td> </tr> </table>	AUDI	SEAT	VW	A3	Arosa Alhambra Cordoba Leon Toledo	Bora Golf New Beetle
AUDI	SEAT	VW						
A3	Arosa Alhambra Cordoba Leon Toledo	Bora Golf New Beetle						

01-P011209

OEM NO.

Application List

	Vw-Seat-Audi 06A 919 081C 036 919 081A	<table border="1"> <tr> <th>AUDI</th> <th>SKODA</th> <th>VW</th> </tr> <tr> <td>A2</td> <td>Fabia Octavia</td> <td>Bora Golf Lupo Polo</td> </tr> </table>	AUDI	SKODA	VW	A2	Fabia Octavia	Bora Golf Lupo Polo
	AUDI		SKODA	VW				
A2	Fabia Octavia	Bora Golf Lupo Polo						
		<table border="1"> <tr> <th>AUDI</th> <th>SKODA</th> <th>VW</th> </tr> <tr> <td>A2</td> <td>Fabia Octavia</td> <td>Bora Golf Lupo Polo</td> </tr> </table>	AUDI	SKODA	VW	A2	Fabia Octavia	Bora Golf Lupo Polo
AUDI	SKODA	VW						
A2	Fabia Octavia	Bora Golf Lupo Polo						
		<table border="1"> <tr> <th>AUDI</th> <th>SKODA</th> <th>VW</th> </tr> <tr> <td>A2</td> <td>Fabia Octavia</td> <td>Bora Golf Lupo Polo</td> </tr> </table>	AUDI	SKODA	VW	A2	Fabia Octavia	Bora Golf Lupo Polo
AUDI	SKODA	VW						
A2	Fabia Octavia	Bora Golf Lupo Polo						

01-P011210

OEM NO.

Application List

	Vw 028 919 081E 028 919 081G	<table border="1"> <tr> <th>AUDI</th> <th>VW SEAT</th> </tr> <tr> <td>Cabriolet</td> <td>Cordoba Ibiza Bora Golf Inca SEATInca Polo Classic Polo Variant VW Transporter VW VENTO</td> </tr> </table>	AUDI	VW SEAT	Cabriolet	Cordoba Ibiza Bora Golf Inca SEATInca Polo Classic Polo Variant VW Transporter VW VENTO
	AUDI		VW SEAT			
Cabriolet	Cordoba Ibiza Bora Golf Inca SEATInca Polo Classic Polo Variant VW Transporter VW VENTO					
Ford 1 094 738						
FAE 12870						
		<table border="1"> <tr> <th>AUDI</th> <th>VW SEAT</th> </tr> <tr> <td>Cabriolet</td> <td>Cordoba Ibiza Bora Golf Inca SEATInca Polo Classic Polo Variant VW Transporter VW VENTO</td> </tr> </table>	AUDI	VW SEAT	Cabriolet	Cordoba Ibiza Bora Golf Inca SEATInca Polo Classic Polo Variant VW Transporter VW VENTO
AUDI	VW SEAT					
Cabriolet	Cordoba Ibiza Bora Golf Inca SEATInca Polo Classic Polo Variant VW Transporter VW VENTO					
		<table border="1"> <tr> <th>AUDI</th> <th>VW SEAT</th> </tr> <tr> <td>Cabriolet</td> <td>Cordoba Ibiza Bora Golf Inca SEATInca Polo Classic Polo Variant VW Transporter VW VENTO</td> </tr> </table>	AUDI	VW SEAT	Cabriolet	Cordoba Ibiza Bora Golf Inca SEATInca Polo Classic Polo Variant VW Transporter VW VENTO
AUDI	VW SEAT					
Cabriolet	Cordoba Ibiza Bora Golf Inca SEATInca Polo Classic Polo Variant VW Transporter VW VENTO					

01-P011211

OEM NO.

Application List

	Vw 06A 919 081B 037 919 081B 037 919 081C	<table border="1"> <tr> <th>AUDI</th> <th>GOLF</th> </tr> <tr> <td>Cabriolet Alhambra</td> <td>Golf Cabriolet Polo Sharan</td> </tr> </table>	AUDI	GOLF	Cabriolet Alhambra	Golf Cabriolet Polo Sharan
	AUDI		GOLF			
Cabriolet Alhambra	Golf Cabriolet Polo Sharan					
FAE 12883						
		<table border="1"> <tr> <th>AUDI</th> <th>GOLF</th> </tr> <tr> <td>Cabriolet Alhambra</td> <td>Golf Cabriolet Polo Sharan</td> </tr> </table>	AUDI	GOLF	Cabriolet Alhambra	Golf Cabriolet Polo Sharan
AUDI	GOLF					
Cabriolet Alhambra	Golf Cabriolet Polo Sharan					
		<table border="1"> <tr> <th>AUDI</th> <th>GOLF</th> </tr> <tr> <td>Cabriolet Alhambra</td> <td>Golf Cabriolet Polo Sharan</td> </tr> </table>	AUDI	GOLF	Cabriolet Alhambra	Golf Cabriolet Polo Sharan
AUDI	GOLF					
Cabriolet Alhambra	Golf Cabriolet Polo Sharan					



01-P011212

OEM NO.

Application List

01



Audi 078 919 081A

AUDI80
110
100
A6
A8
Cabriolet
CoupePRESSURE
2.50bar

01-P011301

OEM NO.

Application List

Opel 1252560
Gm 90240259

FAE 12500

OPELAcaona C1
Corsa A
Kadett E
VectraPRESSURE
0.40bar

01-P022001

OEM NO.

Application List

Renault 77 00 694 210
77 00 715 965
Peugeot 1131.05 1131.10
Ford 1 626 244
78 GB 9278 AA
Talbot 9350087780**FORD**Granada
Sierra**PEUGEOT**204 Diesel
304 Diesel
305 Diesel
504 Diesel
505 GLD,GRD,SRD
604 Diesel,Turbo Diesel
304 Van Diesel
J7 Diesel
J9 Diesel**RENGULT**Fuego Turbo D
R-9 TD,GTD,TDE
R-18 TD,GTD
Turbo D
R-20 TD,GTD
R-30 Turbo DieselPRESSURE
0.80bar

01-P022002

OEM NO.

Application List

Renault 79 46 000 030 91 51 127 980
91 51 443 280
Peugeot 1131.04 1131.48
Citroen 91.511.279 91.514.432
85.511.279 95.591.148
Ford 1626244 78 GB 9278 AB
Talbot 9151127980
Volvo 1218028-7 1218190
1218190-5
Fiat 9151443280**BMW**BX,BX 14,160cc
C 15E 1124-1360cc
C 25E
LNA 11E,RE,RS
Visa Super,Super E
Visa 1360 GT,14 TRS**FORD**Granada Diesel
Scorpio
Sierra**PEUGEOT**104
204,204 Diesel
205
304
305
404,404Diesel
504
604 V6
305 Van**RENAULT**Alpine
R-14 1289-1360C
R-25
R-30**FIAT COMM.**Ducato 1800,2000
Talento 2000**VOLVO**Series240,260
262,264,265
760
780
GLEPRESSURE
0.60bar

01-P022003

OEM NO.

Application List

Renault 77 00 717 982
77 00 752 360
77 01 349 794
Peugeot 1131.54
Fait 79 102 483 33
Volvl 1218360-4
3287726-8**PEUGEOT**505 GTI,STI,Injection
R-9 GTX,TXE,1721CC
R-9 TD,TDE,GTD**RENAULT COUT.**R-11 TX,GTX,TXE,1721
R-11 TD,TDE,GTD
R-25 TX,GTX,2165CC
R-25 2.4V6 Turbo**RENAULT (USA)**Alliance/Encore 1721cc
GTA**RENAULT**Super 5
R-9 GTX,TXE,1721CC
R-9 TD,TDE,GTD**RENAULT Comm.**Espace Diesel,Tubro D
Express Diesel 1565 cc.
Traffic 1721 cc**VOLVO**340,360
760
780
940
960PRESSURE
0.35bar

01-P022004

OEM NO.

Application List

Renault 08 53 621 300 08 55 889 300
77 00 538 670 77 00 644 704
77 00 655 094 77 00 655 787
77 00 694 574 77 00 753 171
77 00 761 254 77 00 786 382
77 01 348 032 77 01 348 033
77 01 365 430 77 02 003 283
77 02 037 714 77 02 138 798
Fiat 4220161 4459907 5967744
Ford 3240239 3248349
Gm 08954566 09301012
Opel 1252506
Peugeot 1131.09**ALFAROMEO**Alfa 155 Gasolina/PetrolDaily
Alfa 164
Spider**FIAT COMM.**Ducato Diesel,Turbo D
Fiorino Fourgon,Combi
Talento Diesel**PEUGEOT**

505 GTI,TI,STI

RENAULT COMM.Express 956-1108-1397
Master T30.T35
R-4 F4,F6**FIAT**126 Bis 704 cc.
Croma
Duna
Panda750,1000,4x4
Regata
Ritmo
Tempra
Tipo
UNO**OPEL**Ascona A,B,C
Commodora A,B,C
Corsa A
Diplomat B
GT,GTJ Manta
Kadett E,B
Manta A,B
Monza A
Omega A
RekordA,B,C,D,E
Senator A,B**RENAULT**Alpine
Espace
Fuego
R-4
R-5
Super5
R-6,R-8,R-7,R-9,R-11
R-12,R-15,R-16,R-17
R-18 1397-1647cc
R-20,R-25TS,GTS,1995cc
R-25 Diesel**VOLVO**340 343 345 B14
343 345 B19A
360PRESSURE
0.35bar



01-P022005

OEM NO.

Application List

A
0.35barB
0.20bar

Renault	77 00 771 825---A 77 00 417 970---B
Volvo	3343427-----A
GM	91 08 194-----B
Opel	44 00 194-----B
Nissan	25240-00QAA---B 25240-00QAD---B 25240-BN700---B



14x1.5

PRESSURE
0.35 & 0.20

RENAULT

Clio 1.2, 1.4. (Energy) 1990- >
Espace 2.0, 2.0 i, 2.2i 1987-96
Espace 2.1 TD, 2.2 TD 1991- >
Laguna 2.2D, DT. (G8T) 1994- >
Megane 1.4 e, 1.6 e 1996- >
Super 5 GTX 1721 cc. 1987-90
Super 5 Diesel 1987-90
R-11 TX, GTS, TXE. 1721 1987-88
R-19 TS, GTS, TSE, 1390 1988-92

RENAULT COMM.

Express (C1, C2, C3) 1987-90
Express 1.4, 1.4 i. (E6J, E7D) 1991- >
Master 2.2 Injection (J7) 1989- >
Trafic 1989- >

RENAULT USA

RENAULT Cont.
R-19 1.2 TR, GTR. (C1G) 1992-96
R-19 1.4 (C1J, C2J, C3J) 1986-94
R-19 1.2 RL, RN. (C1G) 1987-92
R-19 1.4 (C1J, C3J) 1987-92
R-21 TL, GTL. (C2J) 1987-92
R-21 RS, GTS. (C2J) 1987-92
R-21 (A.A.) 1992-97
Twingo 1997- >

RENAULT Cont.

R-19 1.4 (E6J), 1.4 i (E7J) 1992-96
R-21 1986-94
R-25 TS, GTS. 1995 cc. 1987-92
R-25 1995 cc (J7R) 1987-92
R-25 2165 cc A. A. 1987-92
R-25 Diesel, Turbo D 1987-92
Safrane 2V6i (Z7X) 1992-97
Safrane 2.2 TD (G8T) 1997- >
Scenic 1.6 e (K7M-702) 1996- >

RENAULT

Clio 1.1 RL, RN. (C1E) 1990-96
Clio 1.2 RL (C3G) 1995-96
Clio 1.2 i (D7F-730) 1996- >
Super 5 1.0, 1.1, 1.2 1997- >
Super 5 GTL, GTS 1987-90
Super 5 1.4, 1.4 GT Turbo 1987-90
Super 5 (A.A.) 1987-90
R-11 1108-1237-1397 cc 1987-88
R-11 1.4 Turbo 1987-88

RENAULT COMM.

Express 956-1108-1397 1987-90
Express 1.1 (C1E) 1991-96
Express 1.2 (C1G) 1991-96
Express 1.4 (C3J) 1991-96

01-P022006

OEM NO.

Application List

A
0.50barB
0.50barC
0.20bar

Renault	60 01 055 056--A,B 77 00 771 828--A,B
Volvo	3343237-----A,B
Chrysler	TO-771828-----A,B
Mitsubishi	M-851148-----C
Renault	77 00 845 214--C 77 00 834 918--C



M14x1.5

PRESSURE
0.50 & 0.20

RENAULT

Clio 1.7 RT, S, Baccara 1990-96
Clio 1.8 RT, Baccara, RS 1990-94
Clio 1.9 Diesel (F8Q) 1990-94
Clio 1.6V 1794 cc. (F7P) 1991-94
Clio Williams (F7R) 1993-96
Espace 2.0 GTS, TSE. (J6) 1987-90
Espace 2.0 i GTX, TXE. (J7) 1987-90
Espace 2.2 i (J7T) 1987-90
Espace 3.0 i V6 (Z7X-755) 1997- >
Espace V6 Injection (Z7W) 1991-96
Espace D, TD, TDX 1987-90
Laguna 2.0 i 16V 1995- >
Laguna 3.0 V6 (Z7X) 1994- >
R-11 TD, GTD, TDE 1987-88
R-19 1988-97
R-21 (A.A.) 1986-94
R-21 TL, GTL. (F2N) 1986-94
R-21 TS, GTS, TSE. (F3N) 1987-94

RENAULT COMM.

Express 1.9 D (F8Q) 1991- >
Trafic 1989- >

RENAULT USA

RENAULT Cont.

R-21- TXE (J7R-750) 1986-94
R-21 2.0 TXi, GTi. (J7R) 1989-94
R-21 2.0 Turbo (J7R) 1987-94
R-21 TXE 2165 cc. 1987-94
R-21 SD, GSD. 1870 cc. 1989-94
R-21 Turbo DX 2068 cc. 1986-94
R-25 (A.A.) 1988-92
R-25 2.0 Ti, TXi. (J7R) 1988-92
R-25 TX, GTX. 2165 cc. 1987-92
R-25 2.4 V6 Turbo (Z7U) 1988-92
R-25 2.6 V6i (Z7V) 1988-92
R-25 2.8 TX V6, V6i. (Z7W) 1986-92
Safrane 2.0 i, Sl. (J7R) 1992-97
Safrane 2.1 DT (J8S) 1992-97
Safrane 2.2 i, Sl, Vi. (J7T) 1992-97
Safrane 2.5 DT (S8U) 1992-97
Safrane V6i, V6 Quadra 1992-97

01-P022007

OEM NO.

Application List



Renault	82 00 026 650
GM	93 160 284
Opel	44 10 676
Volvo	9128771-4
Nissan	25240-00QAB 25240-AW300
Jaeger	40242801



M14x1.5

PRESSURE
0.50

NISSAN

Interstar
Kubistar
Micra
Primastar

OPEL

Arena
Movano
Vivaro

RENAULT

Clio I
Clio II
Espace III
Kangoo
Laguna
Laguna
MASTER II
Megane
Scenic

**01-P022008****OEM NO.****Application List****01****A**
0.90bar**B**
2.00barNissan 25240-00QAE----A
Renault 82 00 062 452----A
77 00 771 827----B**NISSAN** **RENAULT**Interstar
KubistarClio II
Kangoo
21**01-P022101****OEM NO.****Application List**Peugeot 1131.61 1131.82
Fiat 9618305780
Nissan 25240-6F900
Renault 9618305780
Citroen 96 026 617
Hyundai 94750-29000
Citroen 1131.82 96 026 617
Jaeger 33718201
Rover GPS171
Suzuki 16582-66G00
37820-86CA0
Facet 7.0116**HYUNDAI** **CITROEN**

Lantra

AX 14D
AX 15D
Berlingo
Evasion**01-P022102****OEM NO.****Application List**Peugeot 1131.C5
Citroen 1131.C5
Renault 96 31 846 480
Nissan 25240-6F901
Toyota 83530-02040
Fiat 9631846480

Facet 7.0130**CITROEN** **PEUGEOT** **NISSAN** **RENAULT**Berlingo
Evasion
Eantia
Xsara
C15
C3
C5
C8
Jumper
Jumpy
Saxo
Xanyia
XM
Xsara
Xsara Picasso206
306
406
806
Box
Partner
Expert/Ranch
Espace
Laguna
607
Boxer
RanchMicra

FIAT
Ducato
Scudo
Ulysse

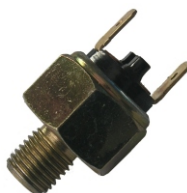
FIAT
Ducato
Scudo
UlysseEspace
Laguna**TOYOTA**
Corolla**01-P022103****OEM NO.****Application List**Peugeot 4608.11
Talbot 4040536724
SG-87171030E
Renault 08 57 030 400

FAE 21060

PEUGEOT **TALBOT**

204

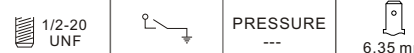
Simca 1100,1300
1301.S
1500,1501.S**01-P022104****OEM NO.****Application List**Peugeot 4608.13
4608.15
Renault 7701 348 720
0854 250 300**PEUGEOT** **RENAULT**203,403
404,404DieselColorale Prairie
Domaine Gordini
Dauphine 1091
Floride Caravelle
Fregate
Ondine
R-8 major
R-10 major
4/4**PEUGEOT COMM.**J7 Gasolina/Petrol
J7 Diesel
J9 Gasolina/Petrol
J9 Diesel



01-P022105

OEM NO.

Application List

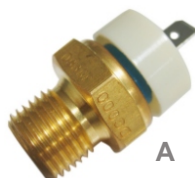

A

Citroen 1131.14 1131.45
 Peugeot 1131.14 1131.45
 Ford 1646357
 86GB9278AB

Facet 7.0021



B



M16x1.5

PRESSURE
0.6bar

6.35 mm

CITROEN

Fukang 988

CITROEN

AX 10, AX 11, AX 14 1987-92
 AX GT, AX Sport 1987-92
 AX 14 Diesel 1989-92
 AX GTI 1991-92
 Berlingo 1.1 i, 1.4 i 1996- >
 BX, BX 14 1986-91
 BX 15, BX 16, BX 19 1983-93
 BX 19 GTI, 19 GTI 16V 1986-93
 BX D, BX 17 D, BX 19D 1983-93
 BX TRD Turbo Diesel 1988-93
 C 15 E 1124- 1360 cc. 1988-94
 C 15 E 1.1 i, 1.4 i 1995-97
 C 15 D 1769 cc. 1984-97
 C 25 D 1905 cc. 1988-94
 Saxo 1996- >
 Visa GTI 1580 cc. 1985-89
 Visa Diesel 1.7 D, RD 1985-89
 XM diesel, Turbo Diesel 1990-93
 XSara 1.4 i, 1.6 i 1997- >
 ZX 1.1 iFlash 1995- >
 ZX 1.4, 1.4 i 1991-93
 ZX 1.9 Diesel ->PR-565d 1991-92

PEUGEOT

106 Gasolina/Petrol 1991- >
 106 Diesel 1991-92
 205 (TU) 1987-89
 205 1.6 GTI, 1.9 GTI 1984-94
 205 Diesel, Turbo D 1983-94
 206 1.1 i, 1.4 i, 1.6 i 1998- >
 305 1.6, 1.9, 1.8 Diesel 1983-88
 306 1.1 i, 1.4 i 1993- >
 306 1.6 i (TU5JP) 1993- >
 309 1.6, 1.9 1986-93
 309 GTI, GTI 16V 1987-93
 309 Diesel 1769-1905 cc 1986-93
 309 1.7 Turbo Diesel 1990-93
 405 1.6, 1.9, 1.9i 1987-93
 405 1.4 i, 1.6 i 1993-96
 405 Ml 16 1987-93
 405 Diesel 1988-93
 505GLD, GRD, SRD 1987-91
 505 Turbo Diesel 2.5 1987-91
 605 Diesel, Turbo Diesel 1990-91

PEUGEOT COMM.

205 Van Diesel 1985-94
 305 Van 1.9 Diesel 1981-88
 J 5 1905 Diesel 1988-94
 Partner 1.1 i, 1.4 i 1996- >
 Ranch 1.1 i, 1.4 i 1996- >

01

01-P033001

OEM NO.

Application List



Ford 0 409 160 1 027 970 81AB-9278-AA
 1 066 811 1 414 897 81AB-9278-BA
 1 647 828 3 466 716 81AE-9278-BA
 6 080 608 6 086 163 86AB-9278-BA
 6 170 902 6 499 475 86AB-9278-BB
 6 513 125 6 716 335 90AB-9278-AA
 90AB-9278-AB 92BB-9278-AA 98FB-9278-AA
 DOHZ-9278-A D4AZ-9278-A
 Mazda 1E00 18 501 1E00 18 501A
 Motorcraft SW 987 Sw1311

1/4-18
NPTPRESSURE
0.3bar

8-32

FORD

Capri MKI, II, III 1969-87
 Consul / Cortina 1970-77
 Escort 1971-88
 Fiesta 1976-88
 Granada 1972-85
 Orion 1983-88
 Scorpio 2.8i, Ghia, RS, XR4i 1985-88
 Sierra 2.0, 2.3 (V6), XR4i 1982-85
 Taunus 1.3, 1.6, 2.0 1971-83

FORD COMM.

Escort Van 1971-88
 Fiesta Van 1.0, 1.1, 1.6 1976-89
 P 100 Cortina Pick-up 1982-88
 Transit 1.6 (OHV) 1965-77
 Transit 1.6, 2.0. (OHC) 1978-87

01-P033002

OEM NO.

Application List



Ford C1TF 9278 B
 C1TZ 9278 A
 C7TZ 9278 D,F
 C9 ZZ 9278 F
 D5 TF 9278 BA,CA
 D5 TZ 9278 C

1/4-18
NPTPRESSURE
0.5bar

8-32

FORD

Ford Truck 1967-90

01-P033003

OEM NO.

Application List



Ford 6703036
 92VB-9278-AA
 6090 246
 6163 243

Facet 7.0031

1/8-28
NPTPRESSURE
0.50bar

M4

FORD

FSD 42S 2.4 D 1991- >
 FSD 42S 2.5 D 1991- >
 Transit 2.5 Diesel 1991- >
 Transit 2.5 Turbo D 1991- >
 Transit 2.5 D 1985-92
 Transit 2.5 DI 1988-00
 Transit 2.5 TD 1985-00
 Transit 2.5 TDI 1994-00

01-P033004

OEM NO.

Application List



Ford XS2Z-9278-AA
 1 053 881
 1 053 882
 1 084 764
 1 095 149
 98AB-9278-AA
 98AB-9278-CA
 Mazda YF609 18 501

1/4-18
NPTPRESSURE
0.40bar

M4

FORD

Cougar
 Escort
 Escort VII
 Fiesta IV
 Fiesta V
 Focus
 Focus RS
 Focus St170
 IKON
 Macerick
 Mondeo II
 Toureo Connect
 Transit
 Transit Connect

MAZDA

Tribute



01-P033 101

OEM NO.

Application List

01



GM 7441302
M-54006,08
M-54013
M-54017
M-54030
IHC 478097C1
Rover Group GPS 154
Saab 88 18 528
93 09 386
FAE 13530

1/4-18
NPTPRESSURE
0.40bar

6.35 mm

BEDFORD

Chevanne 1300

SAAB

90
99,99K-Jetronic
900,900i
900 K-Jetronic
900 Turbo
9000

01-P033 102

OEM NO.

Application List



GM 25036849
25036841
90384292

Standard PS-223

1/4-18
NPTPRESSURE
0.30bar

GM

Asuna 1993- >
Buick 1987-89
GM Light Trucks 1992-93
Oldsmobile 1987-88
Pontiac 1987-94

01-P033 103

OEM NO.

Application List



GM 25036935

Standard PS-222

1/8-27
NPTPRESSURE
0.30bar

G.M.

Buick 1987-88
Chevrolet 1987-96
Oldsmobile 1987-88
Pontiac 1987-88

01-P033 104

OEM NO.

Application List



GM 25036940
Isuzu 8-25036-940-0

Standard PS-211

1/8-27
NPTPRESSURE
0.30bar

G.M.

Buick 1989-96
Cadillac 1994-96
Chevrolet 1988-96
GM Light Trucks 1988-93
Isuzu 1990-91
Oldsmobile 1989-90
Ponyiac 1989-92

01-P033 105

OEM NO.

Application List



GM 3961566
6462549

Standard PS-265

1/8-27
NPTPRESSURE
3.8-5.2bar

6.35 mm

CADILLAC

Deville
Eldorado
Fleetwood/Brougham
Seville

01-P033 201

OEM NO.

Application List



Chrysler 4221289

1/8-27
NPTPRESSURE
0.30bar

6.35 mm

CHRYSLER

Valiant 6 cil
Valiant 8 cil



01-P033202

OEM NO.

Application List



Chrysler 2256800
2585105
3004105

CHRYSLER

3/8-18
NPTPRESSURE
0.20bar

6.35 mm

01

01-P033401

OEM NO.

Application List



John deere 2331154

1/8-27
NPTPRESSURE
2.3bar

6.35 mm

01-P055001

OEM NO.

Application List



Toyota 83530-30010, 83530-30040, 83530-36010, 11
83530-30021, 83530-30050, 83530-30250
Daihatsu 83530-60030-000 83530-30060-000
83530-87102 83530-87201
83530-87701, 2, 3 83530-87205
Isuzu 9-82720-208-2 9-82720-209-0
9-82720-209-2
Mazda 0866-18-501A 2691-18-501A
FEJK-18-501 JF01-18-501
E5D3-18-501
Suzuki 37820-77E90

BEDFORD - G.M.

KB, KB41 4WD Pick-up 1980-91
Midi Van 1800, 2000 D 1985-91
Midi 2.0 TD, 2.2D 1988- >

TOYOTA

Brizzard LD2 1985- >
Camry 1985-90
Carina Diesel 2.0 1982-85
Celica 1979-93
Corolla 1983-93
Corona 1970- >
Cressida 1977- >
Crown 1967-85

TOYOTA

Hi-Ace, Hi-Lux, Life-Ace 1967- >
Soarer M71 1982-83
Sprinter CE90 1987- >
Starlet EP71 1986- >
Tercel 4WD(AL25) 1982-88

OPEL

Monterey 3.1 D 1992- >

1/8-28
BSPPRESSURE
0.30bar

6.35 mm

01-P055002

OEM NO.

Application List



Toyota 83530-14060 83530-14070
83530-30090 83530-05010
83530-28010 83530-28020
83530-30100 83530-60010
83530-AA011
Honda 37240-PHM-003

TOYOTA

Avalon 3.0 i 1994- >
Camry 2.2 i, 3.0 i V6 1992- >
Celica 1.8 i, 2.2 i 1993- >
Corolla 1.3 i, 1.6 i, 1.8 i 1992- >
MR2 2.0 i Turbo, 2.2 i 1992- >
Paseo 1.5 i 1.6V 1992-95
Previa 2.4 i GL, XL 1992- >
Supra 2.0 i, TB 1992- >

TOYOTA Cont.

Tacoma 2WD, 4WD 1995- >
Tercel 1.5 i (3EE) 1992- >
Truck 2.4 i, 3.0 i 1992- >
T100 3.0 i, 3.4 i 1992- >

1/8-28
BSPPRESSURE
0.20bar

01-P055003

OEM NO.

Application List

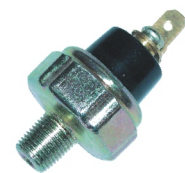

Toyota 83530-10010 83530-14040
83530-10020 83530-14050
83530-12010 83530-30030
83530-12020 83530-30041
83530-12040 83530-30043
83530-14010 83530-30080
83530-14020

TOYOTA

Camry 2.0 GL(ST141) 1984-87
Camry Diesel, Turbo D 1985-90
Camry 2.0 i, 3.0 i V6 1991-92
Carina 1970-88
Celica 1970-92
Coaster, Microbus 1.8 1973- >
Corolla 1966-93
Corona 1975-81
Cressida 2.0 (21R) 1981-82
Dyna Truck 1976- >
FX, FX 16 1987- >
Hi-Ace 1981- >
Hi-Lux 1972- >
Land Cruiser (FJ55, 56) 1975- >
Life-Ace 1973- >
MR2 1985-90

TOYOTA

Paseo 1.5 i 16V 1991-92
Pick-up 1976- >
Previa GL, XL 1990-92
Publica 1000(2K) 1970-77
Spacecruiser F1.8 (2Y) 1983-85
Sprinter 1971-87
Starlet 1978- >
Stout Truck (5R) 1973- >
Supra 1981-88
Tercel 1.3, 1.5 1979-84
Tercel 1.5 (4WD) 1983-86
Tercel 1.5 i 1990-92
Toyo-Ace Pick-up (12R) 1971- >
Truck 2.4, 3.0 i 1988-92

1/8-28
BSPPRESSURE
0.30bar

6.35 mm

01-P055101

OEM NO.

Application List



Honda 37240-PD2-003 37240-PD2-004
37240-PD4-003 37240-PT0-003
37240-PT0-004 37240-PT0-013
37240-PT0-014 37240-PT0-023
Nissan 25240-89900 25240-89901 25240-89902
25240-89910 25240-D9700 25240-W5740
25240-Y9501 25240-Y9700
Isuzu 8-94118755-0 8-94312940-0
Hyundai 94750-11110
Renault 7701 052 674
GM 94118755 94312940
Opel 1252561 1252565

NISSAN

Almera Diesel 1993-96
Bluebird 160B, 180B 1971-80
Cherry (100A, 120A, F11) 1970-79
Laurel (C30, C130, C230) 1970-79
March 1.0, 1.0 turbo 1982-86
Patrol 60, C80 Truck 1965-79
Pick-up SD-25 (USA) 1985-87
Primera 2.0 Diesel 1993-96
Puslar (USA) 1981-86

NISSAN

Sentra (USA) 1982-83
Stanza 1.6, 1.8, (T11) 1982-84
Sunny 1.2 (B110, 120Y, 210) 1973-78
Violet (C30, C130, C230) 1970-79
Violet 140J, 160J, (710) 1973-82
160 K, 180 K, Skyline 1972-79
200 C, 240 C, 260 C 1966-79
240 K GT Skyline 1975-79
280 C (Cedric, Gloria) 1977-79
1000, 1200, 1300 1965-75
1400, 1600 1965-75
2000, 2300, (130, 230) 1968-70

1/8-28
BSPPRESSURE
0.30bar

4 mm



01-P055102

OEM NO.

Application List

01



Honda	37240-657-013	37240-657-305
	37240-657-003	37240-P13-003
	37240-P13-004	37240-P13-013
	37240-P13-014	37240-PA6-004
	37240-PCX-003	
Mazda	0222-18-501,A	0813-18-501,A
	R 207-18-501	R 207-18-5010
Suzuki	37820-82001	
Daihatsu	83530-87704	

1/8-28
BSPPRESSURE
0.30bar

HONDA

Accord 1600.1800
Accord 2.3i SR
Ballade 1300,1500
Civic
Legend
Jazz/city1231cc
Prelude 1600,1829
Coupe
Prelude
Quintet.Vigor

MAZDA

626 626 II 626III
E2000

SUZUKI

Alto
Jimmy
Samurai
Sidekick
Swift
Vitara
Baleno
Esteem
Grand Vitara
Ignis
Sa413
SAMURAL
Sidekick
SJ410,SK410
Super-carry
Wagon R,X-90

01-P055201

OEM NO.

Application List



Nissan	25240-G2400	25240-89960
	25240-70J00	25240-89915
	25240-89920	
Ford	1953653	1953654
Renault	25 24 089960	

1/8-28
BSPPRESSURE
0.20bar

INFINITI

G20 / J30 / M30

1990- >

NISSAN Cont.

Primera 1.6 / 2.0

1990- >

Pulsar NX 1986- >

Quest / Sentra 1984- >

Serena 1.6 i / 2.0i / 2.0D 1992- >

Silvia / Stanza / Sunny 1990- >

Terrano / Van 1986- >

Vanette 1985- >

NISSAN

Altima / Axxess 1989- >

Bluebird / Maxima / Micra 1988- >

NX600 / NX2000 1990- >

Pathfinder 1986- >

01-P055202

OEM NO.

Application List



Nissan 25240-4M400

1/8-28
BSPPRESSURE
0.15bar

NISSAN

Almera ii
Almera ii Hatchback
Almera Tino
Patrol GR II
Primera
Primera Estate
Terrano II
X-Trail

01-P066001

OEM NO.

Application List



Kia KK150-18-501D

Facet 7.0016

1/8x28
BSPPRESSURE
0.3

KIA

Pride

MAZDA

01-P066002

OEM NO.

Application List



Kia OK900-18-501C
Hyundai 94750-21030

1/8x28
BSPPRESSURE
0.3

KIA

Carnival
Clarus
Sedona
Sephia
Sporage

HYUNDAI

Accent
Amica
Atos
Coupe
Elantra
Excel
Gallopier
Lantra
Pony
Precis
Scoupe
Sonata
Stellar
Tiburon

01-P066101

OEM NO.

Application List



Daewoo 90336039

96281689

GM 55 354 378

90 335 039

90 336 039

Opel 12 52 557

12 52 562

Saab 45 04 585

90 568 684

Facet 7.0069



M14x1.5

PRESSURE
0.3-0.55bar

DAEWOO

Lanos
Leganza
Nubira
Rezzo
Tacuma

OPEL

Astra F
Astra G
Calibra A
Combo
Corsa
Frontera B
Kadet
Meriva
Omega
Senator
Signum
Sintra
Speedster
Tigra
Vectra,Zafira



01-P00002

OEM NO.

Application List

01



Volvo 1347003
1347003-4
3545316-6
3545696-1

M14x1.5

PRESSURE
0.50bar

VOLVO		VOLVO Cont.	
Series 240	1988-93	940 2.3 i (B230)	1990- >
Series 260	1988-93	940 2.3 i Turbo (B230FT)	1990- >
360 2.0, 2.0 i. (B200)	1984-89	960 2.0 i (B200, B204)	1990- >
740 2.0 GL, 2.0 i. (B200)	1984-90	960 2.0 i Turbo (B200FT)	1990- >
740 2.0 i (B204)	1987-90	960 2.3 i (B230, B234)	1990- >
740 2.3, 2.3 i. (B230)	1984-90	960 2.3 i Turbo (B230FT)	1990- >
740 Turbo (B23FT)	1984-90	960 2.9 i 24V (B6304F)	1990- >
760 GLE (B23F)	1983-89	850 2.0 i (B520)	
760 Turbo (B23FT)	1985-90	850 2.0 i Turbo	1991- >
780 2.0 i (B204GT)	1987-90	850 2.3 i Turbo (B523)	1991- >
780 2.0 i Turbo (B200ET)	1987-90	850 2.4 i (B525)	1991- >
	1991- >	940 2.0 i (B200, B204)	1990- >
	1990- >		

01-P099001

OEM NO.

Application List



A

Application/Suitable

Paykan
Fiat 33331115
Land Rover RTC3651
Rover GPS101
GM 94 603087



B

Facet 7.0027

 1/8-27
NPTF
PRESSURE
0.50

6.35 mm

PAYKAN

AUSTIN

INNOCENT

ROVER

800 820
Maestro
Mini
Montego



02-W011001

OEM NO.

Application List

	Mercedes 005 565 0324 002 542 25 17 005 542 10 17 005 542 26 17 Daewoo 6615423017 Volkswagen 2D0919 501C			----	
	M14x1.5				

Mercedes Benz	Mercedes comm.	DAEWOO
190 D 190 Turbo D 200 D 200 Turbo D 250 Dissel 250 Turbo D	208 D 308 D 408D 508D L-407D L-407DG MB 100 MB 120 MB 140 MB 180 O-309 D	Korando Musso
Mercedes cont .		
C 200 D C 200 Turbo E 200 D E 220 D F 250TD		

02

02-W011002

OEM NO.

Application List

	Mercedes 008 54245 17			----	
	Facet 7.3139				

Mercedes BENZ	Mercedes cont .	Mercedes cont .
200 CE,E,TE. 200 D,TD,AA. 220 CE,E,TE. 280 E,TE. 300 E,CE,SE,SEL,TE 320 CE,E,TE. 400 E,SE,SEL. 500 E,SE,SEC,SEL,SE.	600 SE,SEC,SEL,SL,V12 C 180 C200, C220 C 200 D C 280 E 200 E 200 Diesel E 220	E 250 TD E 420, E 500 S 280, S 320 S 420, S 500 S 600 V12 SL 280, SL 320. SL 500

02-W011003

OEM NO.

Application List

	Mercedes 002 54273 17 007 542 09 17 004 542 56 17			102°C	
	Facet 7.3515				

Mercedes BENZ
LK/LN2 814 LK/LN2 817 MK 1222 MK 1224 AF MK 1226 AF MK 1227 A MK 1422 MK 1424 MK 1427 F MK 1722/26 MK 1827/31 MK 2422/26 MK 2524/27/31 NG 1019, 1219, 1222 O 303-404-405 S K 1831-3538

02-W011004

OEM NO.

Application List

				105°C	

Mercedes BENZ

02-W011005

OEM NO.

Application List

	BENZ 008 54256 17 Volkswagen 062919 501			19	

Mercedes BENZ	Volkswagen
C-Class E-Class G-Class S-Class Sprinter Saloon V-Class Vito	28-46 II Box 28-46 II Flatbed/Chassis

02-W011006

OEM NO.

Application List

	BENZ 000 54251 18 Smart 0003118V002 0000 00			----	

BENZ	PUCH
CL Classe AA Classe CC Classe EE Classe GG Classe M ML Classe S Classe V CLK SL Sprinter Vaneo VITO	G-Modell G 500
SMART	
Cabrio City-Coupe	



02-W011007

OEM NO.

Application List



Mercedes 001 54223 17

Mercedes Benz

L-406 D
207 D 65 CV.
307 D 65 CV.
Motor/Engine om616-934
Camiones/Trucks

Mercedes Benz

1060,1061,1090,1093
1080-50,1083-50,1086-50
1091,2010,2011,2080,3060
1217 T1,1231 T1
1217,1223,2323K T2
2011-50,2090-50,3068
2181/60,3076-D Turbo
5020,5022,5051,6030.
Autobus/Bus 5720.20

M14x1.5



M4

02

02-W011201

OEM NO.

Application List

Seat 027 919 501
049 919 501
WO 049919.501
SE-021947000I
Volvo 1257216
3517501
3517501-7
VW 049 919 501A
049 919 501 1
175 919 501

Facet 7.3073

M10x1



4



6.35 mm

Volkswagen comm.

Caddy
Caracelle
Golf van
LT Series
Transporter
Vanagon

Volkswagen

Corrado
Dasher Diesel
Derby
Golf/Jetta/Scirocco
Passat/Santana
Polo.Clsaaic.Coupe

AUDI

50
80
90
100
Coupe
Quattro
4000
V8

SEAT

Alhambra
Ibiza II
Malaga
Terra
Toledo

Volvo

740 Diesel
760 GLE Diesel
780 Diesel
940 Diesel
960 Diesel

02-W011202

OEM NO.

Application List

VW 035 919 369M
BMW 12 62 1288 158
13 62 1 288158
Ford 1 626 473
Seat 035 919 369M
Volvo 1275494
Mercedes 004 153 1628
004 153 25 28

Facet 7.3126

M14x1.5



19



VOLKSWAGEN

Golf Syncro GT
Golf
A6
Passat
SEAT

AUDI

90
100
A6
A8
Coupe
Quattro
Rs2
S6
V8

FORD

BMW

Serie 7 (E32)
730
750
840
850

02-W011203

OEM NO.

Application List

VW 034 906 161
026 906 1612
Bosch 0280 130 053
0280 130 054

Facet 7.3229

M10x1



19



AUDI

80
90
100
A6

AUDI Cont .

Cabriolet
Coupe

02-W011204

OEM NO.

Application List



VW 251 919369

VW
Golf
Polo
Santana
Scirocco
Transporter

Ø 20 mm



02-W011205

OEM NO.

Application List

VW 059 919501A
078 919 501C
Skoda 059 919501A
Seat 059 919501A
Ford 1100619
1124770
XM21-8A570-BA

Ø 20 mm



VW

GOLF IV
New Beetle
Passat

Ford

Galaxy

Skoda

Octavia
Superb

SEAT

AUDI

A2
A3
A4
A6
A8
TT

SEAT

Alhambra
Arosa
cordoba
Ibiza
Inca
Leon
Toledo
Cordoba



02-W011206

OEM NO.

Application List

	VW 002 542 07 18 Mercedes 002 542 07 18 Ford 1 669 965 95VW-12A648-BA Seat 025 906 04 1A Renault 77 00 865 290 GM 09109661 Mitsubishi M-809548 Volvo 30809548	Facet 7.3101 FAE 33630 VDO 323.805/013/001 Standard TS-360				

AUDI	SEAT	VW COMM.
80 100 A4 A6 Coupe	Alhambra Cordoba Ibiza Inca Toledo	Caddy Caravelle LT Transporter
FORD	VW	
Galaxy	Corrado Golf Passat Polo Vento	

02

02-W011207

OEM NO.

Application List

	VW 078 919 501B 059 919 501					

AUDI	SEAT
A3 A4 A6 A8 Cabriolet	Alhambra Arosa Cordoba Ibiza Toledo Octavia
Volkswagen	
Bora Golf Lupo New Passat Polo Sharan Transporter	

02-W011301

OEM NO.

Application List

	Opel 1338448 1342561 1342567 1342568 GM 90246852 94472002 03439088 Daewoo 03439088	Facet 7.3005				

OPEL	OPEL COMM.
Admiral B Admiral A,B,C Astra Caltra Commodore A,B,C Corsa A,B Diplomat B Frontera GT,GT1/J Kadett C,D,E Kapitan B Manta A,B Monza A Omega Rekord C,D,E Senator A,B Tigra Vectra	Astra Furgon Bedford Blitz Combo Kadett Van Rekord
DAEWOO	
	Aranos Espera

02-W011302

OEM NO.

Application List

	Opel 1342855 GM 90573077	Facet 7.3268				

OPEL
Vectra OMEGA

02-W011303

OEM NO.

Application List

	Opel 12 36 302 13 38 450 GM 25036979 25037182 25036708 10045847 12146312 15326386 Daewoo 25036797 Fiat 7 604 097	Honda 8-2503-697-90 Isuzu 8-25036-979-0 Chrysler 33004281 Mitsubishi M33004281 Md3004281	Facet 7.3129 Standard Tx3 Mte-thomson 4040				

GM	OPEL	DAEWOO
Acura Asuna Buick Cadillac Chevrolet GM HD trucks GM Light trucks Geo Honda Isuzu Jeep Oldsmobile Pontiac	Astra Corsa Frontera Monterey Omega Lotus	Aranos Espero
HONDA	Chrysler	
Passport	Chrysler Dodge Eagle Jeep Mitsubishi Plymouth	
ISUZU		
Pick-up Rodeo Trooper		

02-W022001

OEM NO.

Application List

	Renault 7910245553 7910245551 Peugeot 0242.20 Ford E1ZZ-10884A Fiat 7910247507					

RENAULT
Alpine A310 Fuego R-9 R-11 R-8 R-20 R-30 Trafic



02-W022002

OEM NO.

Application List



Renault	0242.63 77 00 686174 77 00 767102 77 01 348488	Peugeot	1337.72 1338.02 0042790300 0015794500
Citroen	97509510 97519138 95495591 95579683 0424.43 0424.30	Talbot	97 509 51080 SM-71446000
		Volvo	299085-7
		Facet	7.3007

M14x1.25		---	6.35 mm
----------	--	-----	---------

RENAULT	PEUGEOT	CITROEN
Espace Turbo D,DX	205 Diesel	AX
Fuego	205 Van Diesel	BX
Master	305 Diesel	C15E,C15D
R-9	305 Van	C25E,C25D
R-11	405	Visa
R-18	504	ZX
R-25 TX,GTX,TXE.	505	
R-25 TD,GTD,TBD,TDX	604	
Trafic	604	
Trafic Diesel 2068cc.	J5	

02

02-W022003

OEM NO.

Application List

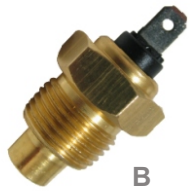
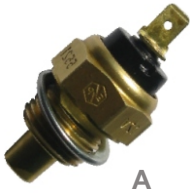

Renault	77 00503 200 77 01 349086
Citroen	95.581.212
Peugeot	0242.14
Fiat	5494830
Talbot	7810240000

Facet 7.3008
FAE 31020

Peugeot	0242.14
Citroen	95.581.212
Renault	77 00503 200 77 01 349086
Talbot	7810240000
Fiat	5494830

FAE 31020

M18x1.5		21	6.35 mm
---------	--	----	---------

CITROEN	RENAULT
C 25D	Estafette
CX	R-5,R-8,R-12,R-14
Visa	R-15,R-16,R-17,R-18
	Fuego.1397
	R-20L,TL,T GTL.1647
	Trafic 1397 cc.

PEUGEOT
104
204
304
404
504
J5,J7,J9

FIAT COMM.
Ducato Diesel Motor CRD

02-W022004

OEM NO.

Application List



Renault	77 00 737 571 77 00 869 343
GM	91 09810
Opel	4401 810
Volvo	3344169 3345511

Facet 7.3191

M12x1.5		---	
---------	--	-----	--

RENAULT	VOLVO
Alpine	440
Clio Injection	460
Espace	480
Laguna	
Megane Injection	
R-19	
R-21	
Safrane	
Scenic	
Twingo	
Express	
Master	
Trafic	

02-W022005

OEM NO.

Application List



Renault 77 00810 879

RENAULT	OPEL
Clio	Movano
Kangoo	Carisma
Megane	
Megane break	
R-19	
Scenic	
Express	

M14x1.25		115°C/120°C	
----------	--	-------------	--

02-W022006

OEM NO.

Application List



Renault 77 00778 782

RENAULT
Alpine
R-19
R-25
Master
Trafic

M14x1.25		120°C	
----------	--	-------	--



02-W022007

OEM NO.

Application List

	Renault 77 00 101 968 77 00 113 867 Nissan 22630-00QAB GM 91 159949 Opel 4408333			
	FAE 33725			

RENAULT	FIAT	NISSAN
Avantime Clio II Espace Kangoo Laguna Master Scenic Trafic Twingo Vel satic	Palio Siena	Kubistar Primastar

02

02-W022008

OEM NO.

Application List

	Renault			
	Ø 9.5mm			6.35 mm

RENAULT
R-5 R-8 Major R-10 R-10 Major

02-W022101

OEM NO.

Application List

	Peugeot 1338.A7 1338.88 Citroen 96368023 Renault 9636777180 Fiat 9628454680 Toyota 89422-02020			
	Facet 7.3276			

CITROEN	PEUGEOT	RENAULT
Berlingo C15 C8 Evasion Jumpy Xsara	206,307,406, 607 806 807 Expert Partner	Avantime Laguna

02-W022102

OEM NO.

Application List

	Citroen 96.368.027 96310010 Peugeot 1338 A6 1338 97 Renault 963677728 Fiat 9631000880			
				21

CITROEN	RENAULT	PEUGEOT
Berlingo C3 Jumper Saxo Xantia Santia	Clio FIAT Ducato Ulysse	106 206 306 307 406 Partner

02-W022103

OEM NO.

Application List

	Peugeot 1338.C7 Opel 13 38 467 62 38 266 13 38 511 62 38 422 62 35 605 62 38 935 62 38 179 Fiat 500382599 99455420 60814715 GM 15 393755 91 298 691 90541 520 93 174 208 90 541 937 97 227 219 90 542 063 Facet 7.3239			
				19

PEUGEOT	CITROEN	FIAT
Boxer	Jumper	Bravo Ducato Marea Multipla
OPEL		
Astra Vectra Zafira		

02-W022104

OEM NO.

Application List

	Citroen 1338.10 1338.55 Peugeot 1338.10 1338.55 Fiat 9603324880 9621000680			
				19

PEUGEOT	CITROEN	FIAT
306A/C 405A/C 406A/C 106 605 805 Boxer Expert Partiver	AX Evasion ZX Xantia XM Berlingo Jumpy Saxo Sxara	Ducato Scudo Ulysse



02-W022105

OEM NO.

Application List



Peugeot 1338.85
Fiat 9625202480
Citroen 1338.85

FAE 34430

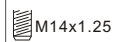

50 °C



CITROEN

Berlingo
Xsara
Jumpy
Scudo

PEUGEOT

206
306
Expert
Partner
Ranch

02

02-W022106

OEM NO.

Application List



Peugeot 1338.86
Fiat 9624350280
Renault 9624350880
9624350280

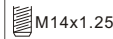

115 °C



PEUGEOT

206
306
Partner
Ranch

CITROEN

Berlingo
Jumpy
Xsara

FIAT

Scudo

02-W022107

OEM NO.

Application List



Citroen 96.018.426
Peugeot 1338.09
Fiat 9601842680

FAE 32290

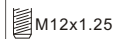

19



CITROEN

AX
Berlingo Diesel
Jumper Diesel
Turbo D
Jumpy
Xantia
XM
Xsara
ZX

FIAT

Ulysse
Ducato

PEUGEOT

106
306
405
406
605
Boxer
Expert
Partner
806

02-W022108

OEM NO.

Application List

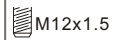

Peugeot 1920.k9
Citroen 96.131.470
Fiat 9613147080

FAE 33120
Facet 7.3148

19



PEUGEOT

106
306
405
406
605
Boxer
Expert
Partner

CITROEN

Berlingo
Evasion
Jumper
Saxo
Xantia Injection
XM
Xsara Injection
ZX

FIAT

Ulysse

02-W022109

OEM NO.

Application List



Peugeot 0242.83
Citroen 0242.83

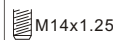

117 °C



PEUGEOT

206
306
Partner
Ranch

CITROEN

Berlingo
Saxo
Xsaxo
Xsara

02-W022110

OEM NO.

Application List



Peugeot 1338F8
Citroen 96566364





CITROEN

PEUGEOT



02-W022111

OEM NO.

Application List

	Peugeot 1338C1 Fiat 9632562080 Citroen 96.325.624 Ford 1 204 700 1 342 631 2S6Q12A648AA 2S6Q12A648AB	
	Ø 20 mm	

CITROEN	FIAT	PEUGEOT
Berlingo C3 C5 C8 Xsara Xsara picasso	Scudo Ulysse	307 406 607
	FORD	
	Fiesta Fusion	

02

02-W022112

OEM NO.

Application List

	Citroen 1920 Y7 Fiat 7760958 Peugeot 1920 Y7	
	Facet 7.3547	

CITROEN	FIAT	PEUGEOT
Jumpy	Scudo	Expert

02-W022113

OEM NO.

Application List

	Citroen 95.640.493 Renault 1290.C4	
	Facet 7.3177	

CITROEN	PEUGEOT
AX XM ZX	106 205 306 309 405 605

02-W033001

OEM NO.

Application List

	Ford 3 405 645 3 465 427 3601 374 B3C8-18840 B593-18840-A F32Z-12A648-A F42Z-10884-A GM 91 171 768 96 062 513 Mazda B 3C8-18-840 B593-18-840A N 391-18-840 N F02-18-840 Y 702-18-840 Suzuki 13650-51G10 13650-57F00 13650-61B00 13650-71C00 Toyota 89422-20010 89422-35010 Volkswagen J89 42220010 Volvo 30874172 8653103	
	Facet 7.3177	

FORD	MAZDA	SUZUKI-SANTANA	TOYOTA
Probe Ranger	121 323 626 929	Samurai Siderick Sj413 SWIFT VITARA	Mr2 PASEO Pick up previa RAV Supre Tacoma Tercel Truck T 100 Van 4 Runner
VOLVO	B 2200 Miata MPV	TOYOTA	
S40 S60 S80 V40 V70 Xc70 Xc90	MX-3 MX-5 MX-6 RX-7 Xedos-6	Avalon Camry Carina E Celica Corolla Cressida land cruiser	
VOLKSWAGEN			
Taro			

02-W033002

OEM NO.

Application List

	Ford 1583836 6058836 1657685 77 FB-10884-AA 89FB-10884-AA	
	Facet 7.3028	

FORD
Capri Consul Cortina(GB) Escort Escort RS Fiesta Ganada Taunus Zephyr. Escort van FT Series P 100 Cortina pick-up Transit

02-W033003

OEM NO.

Application List

	Ford 6136366 6146864 6 108 298 6 113258 85 FB 10884AA 86 AB 10884AA 84 DA 10884AA	
	Facet 7.3136	

FORD
Escort Fiesta Orion Transit KA Sierra Courier Fiesta



02-W033004

OEM NO.

Application List



Ford 1784077
6076967
81 AB 10884 AA
C4 AH 10884

Facet 7.3069



FORD

Corsair
Escort
Fiesta
Orion

02

02-W033005

OEM NO.

Application List



Ford 7203359
95VW-10A998-AA
Seat-VW-Skoda 1H0 919563

Facet 7.3154



FORD

Alfa 33

SEAT

Alhambra
Cordoba
Ibiza
Inca
Leon
Toledo

SKODA

Tractores/tractors

VOLKSWAGEN

Bora
Corrado
Golf
Passat
Polo
Vento

02-W033006

OEM NO.

Application List



Ford 1626262
3340711
3408302
3510216
F2AF-12A648AA
1629085
6740335
1644646
3331737
3510218



FORD

Escort
Fiesta
Galaxy
Granada MKIII
Mondeo
Orion
Scorpio
Sierra/Sapphire
Combi van
Courier van
Fiesta van
P 100
Transit
Sapphire

FORD

Sierra
Transit TD

02-W033007

OEM NO.

Application List



Ford 4 337456
7 158 126
F5AF-12A648-AA
F5AF-12A648-AB
Mazda 1 E00 18 510
Z ZM1-18-707

Facet 7.3284



MAZDA

121 III

FORD

Cougar
Escort
Fiesta
Focus
Fusion
Galaxy
Ikon
Ka
Mondeo
Orion
Puma
Scorpio
Transit
Windstar

02-W033008

OEM NO.

Application List



Ford XS2Z-10884AA
XS6Z-12A648CA

SMP TX-90
MTE-THOMSON 4067
IGUACU 815



FORD

Ford
Ford truck
Mazda
Mercury

02-W033009

OEM NO.

Application List



Ford 98FF-6G004-AC
YS4Z-6G004-AB
1 079 267
4 074 917

SMP TS-431









02-W033010

OEM NO.

Application List





	Ford 6146863 85BB-10884-AA			FORD Sierra
	 1/8-27 NPT		 13	 M5

02

02-W033011

OEM NO.





Application List

	Ford C6DZ-10884A C6DZ-10884B D0HZ-10884A D9TZ-10884A			FORD HD Trucks Lincoln	GM Chevrolet
	 3/8-18 NPT		 17	 M4	

02-W033101

OEM NO.





Application List

	GM 25036135 25037346 8993115 8993146 8993164			GM AMC Buick Cadillac Chevrolet HD Trucks Light Trucks Oldsmobile Pontiac
	 3/8-18 NPT		 22	 6.35 mm

02-W033102

OEM NO.





Application List

	GM 21020124			GM Saturn
	 1/8-27 NPT		 13	

02-W033103

OEM NO.





Application List

	GM 25037345 8993105 8993106 8993107 8993372			GM Buick Chevrolet HD Trucks Light Trucks
	 1/2-14 NPT		 21	 6.35 mm

02-W033104

OEM NO.

Application List

	GM 12334869 1512678 1513130 1513321 1513462 546702 6400759 6402382 6402383 6489277 6489278			GM Buick Cadillac Chevrolet GMC Oldsmobile Pontiac
	 1/2-14 NPT		----	 6.35 mm



02-W033201

OEM NO.

Application List



Chrysler 5011852AA

CHRYSLER

Dodge light trucks

M14x1.5



19



02

02-W055001

OEM NO.

Application List

Toyota 83420-12010
83420-20011
83420-16010
83420-20020
Subaru 21203-AA000
82080-4150

Facet 7.3042

M16x1.5



17

6.35 mm

TOYOTA

Daihatsu 1300,1600

SUBARU

1300,1400,1600,1800
Leone
Loyale
L Series
XT CoupeCarina
Corolla
Celica
Cressida
Crown
Dyna pick-up,Truck
Hi-Ace Van,pick-up
Hi-Lux Pick-up
Landcruiser
Publica 1000
Sprinterr
Starlet
Stout truck
Supra
Toyo-Ace Pick-upToyota 83420-16010 83420-20010 83420-20020
GM 94841819 94847543
Hyundai 94650-11110
Mitsubishi MD-001380 MD-603427 MD-095556
Subaru 21203-AA000 82080-4150
Volkswagen J83420 200 20

Facet 7.3041

M16x1.5



17

6.35 mm

TOYOTA

TOYOTA

MITSUBISHI

MITSUBISHI

Camry
Carina
Celica
Corolla
Corona
Cressida
Crown
FX,FX16,GTS
Hi-Ace
Landcruiser
Lite-Ace
Mr2
Pick-up
PreviaSpaceCruiser
Starlet
Supra
Terrel
Truck
4RunnerArrow
Celeste
Colt 1200,1400,1600
Conquest
Cordia
Decia
Eterna
Foklift
Fortie 1600
Galant
Jeep
Lancer
L200,L300
MirageMontero
Pajero,Shogun
Pick-up
Sapporo 1600,2000
Sigma 1600,1850,2000
Stredia
T120van,Pick-up

02-W055002

OEM NO.

Application List

Toyota 83420-16020 83420-16030
Daihatsu 83420-8703000
GM 94247437 91138061 96052069
Hyundai 94650-32500 94650-32510 94650-32520
Isuzu KL01-18-51X B541-18-51X JE15-18-51X
Mitsubishi MD-091056 94650-32510 94650-32520
Subaru 21230-AA030
Suzuki 34850-82011 34850-82012 34850-82001
Ford 3 395475 Facet 7.3079 7.30801/8-28
BSP

12

6.35 mm

MITSUBISHI

TOYOTA

Colt
Cordia
Diamante,Eclipse.
Expo
Galant
L200,L300,pick-up,Van
Mirage
Monter,Pajero
Precis
Space Runner.Space wagon
Truck,van
3000 GTCamry
Celica
Corolla
Mr2
Paseo
Sprinter
Starlet
Tacoma
Terrel
Truck
4 Runner

02-W055003

OEM NO.

Application List

Toyota 89422-05010 89422-05020
Isuzu 8-94205-866-0
BMW 13 621284 397 13 621 401 945
13 621 709966 13 621357 414
Citroen 91 514 549 0242.46 1338 57
GM 90 410792 90 080939 90 510 183
92 017 805 94 205 866
Hyundai 39220-22010
Isuzu 8-94205-866-0
Opel 13 38444 13 38451 13 38458 62 38 317
Peugeot 0242.46 1338.57
Volkswagen 025906 041 6U0919 501
X03 952 640
Volvo 1332396-9
Nissan 11023-V0700 22630-10G00
22630-G2402 22630-N4200
22630-P8100
Renault 77 00582 688
Skoda 004 435010
Ford 1957 002
Bosch 0280 130025 0280 130026
0280 130 033 0280 130 068
0280 130 077 0280 130 107
Land Rover ERR2081
Saab 45 03 132 93 57 021 47 70 228
Seat 025 906041

Facet 7.3127 7.3128

M12x1.5



19



TOYOTA

OPEL

CITROEN

AVENSIS
VOLVO
340,360,740,760
VOLKSWAGEN
Caravelle
Golf
Vento
Transporter Type2Ascona Injection
Astra except diesel
Calibra
Combo
Corsa
Frontera
Kadett
Manta B,Monza A
Omega
Rekord E,SenatorA
SenatorB
Sintra
Tigra
VectraAx11
BX19GTI,TZI,GT16V
C15E
Cx25
Jumpy 1580 SPI
Visa
XM
ZX

SKODA

Favorit
Felicia
Pick-up

ISUZU

Amigo
Rodeo
Trooper

SEAT

Ibiza Injection
Malaga Injection
Toledo

HYUNDAI

Accent
Coupe
Scoupe

SAAB

900.9000

FIAT

RENAULT
Laguna
R-25 Injection
PEUGEOT
106,205,305,306
309,405,505,606Barchetta
Brava/Bravo
Croma
Fiorino
Marea
Panda
Punto
Tempra
Tipo DGT
UNO

BMW

316
320
325
518
520
525
530
535
728
735
M3
M5
Z1



02-W055004

OEM NO.

Application List

	Toyota 83420-16040 83420-20030 Volkswagen J8342020030 J8342016040			
	Facet 7.3161			
	M16x1.5			

TOYOTA	VOLKSWAGEN
Camry Carina Celica Hi-Ace Land Cruiser Mr2 Previa RAV4 Supra Truck	Taro

02

02-W055101

OEM NO.

Application List

	Honda 37750-611-154 Mazda 0 118 18 510 0 11889 181 Suzuki 34850-65011 34850-78E21 Ford D27Z-10884A Fiat 553621200 6553621200 Daihatsu 83420-87701 83420-87701-000			
	Facet 7.3161			
	M16x1.5			

DAIHATSU	ISUZU	SUZUKI
Charade/Delta/Hijet	Trooper II	Carry L50,LJ50,ST90K Cervo Jimmy 800(4WD)797cc LJ50,LJ80,LJ81 Sj410 Super Carry

HONDA	MAZDA
Accord 1600,1800 Ballade 1300,1500 Civic Prelude 1600,1829 Quintet,Quint SV	626 629 Rx9 B 1600,1800,2000,2200

02-W055102

OEM NO.

Application List

	Honda 37750-PC1-004 Mazda G607-18-510 Rover GTR 141 GTR 142 Ford E92Z-10884-C Kia KK150-18-51X KK151-18-510 KK151-18-510A			
	Facet 7.3056			
	1/8-28 BSP			

HONDA	MAZDA	KIA	ROVER
Accord City 45,56 Civic Integra Jazz Legend Prelude Vigor	121 323 B 2200 B 2600	Pride Trade	200 213S 200 216 GSI 400 416 800 827

02-W055103

OEM NO.

Application List

	Honda 37870-PJ7-003 37870-PK2-005 48160-96K-004 ISUZU 5-86202-847.0 Rover MEK 100070 MEK 100120 GTR210			
	Facet 7.3198			
	M12x1.5			

ACURA	HONDA	ROVER
Integra Legend NSX Odyssey Vigor	Acord Civic Concerto Prelude CR-V CRX Insight Legend Nsx Odyssey	400 416Si 600 618 620 623

02-W055104

OEM NO.

Application List

	Honda 37870-PLC-004 37870-PNA-003			
	Facet 7.3299			
	M10x1.25			

HONDA
Civic CR-V Jazz Stream

02-W055201

OEM NO.

Application List

	Nissan 25080-89900 25251-37700			
	Facet 7.3161			
	11 mm			

NISSAN-DATSUN
Bluebird Cherry Laurel,Laurel sixl Patrol60,Truck80 4WD Stanza Sunny Violet



02-W055202

OEM NO.

Application List

Nissan 25080-89903
25080-F3900

Facet 7.3078



NISSAN

Altim
Bluebird
Cherry
Langley
Liberta
March
Maxima
Micra
Pathfinder
Patrol GR
Pick-up
Prairie
Primera
Pulsar
Sentra

NISSAN

Stanza
Sunny
Terrano
100 NX
200 SX
240 SX
300 ZX

02

02-W055203

OEM NO.

Application List



Nissan 25280-89902

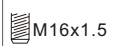

NISSAN

Bluebird
Laurel six
Pick-up
Prairie
Pulsar
Sentra
Silvia
Stanza
Sunny
Terrano
200 SX
280 ZX
310,510
720 Pick-up

02-W055204

OEM NO.

Application List



Nissan 25080-62200



NISSAN

Nissan 1.3

02-W055205

OEM NO.

Application List



Nissan 25080-9F900



NISSAN

Almera
Sentra
Sunny
100NX
Maxima
Pathfinder
Pick-up

02-W055206

OEM NO.

Application List

Nissan 22630-44B10 22630-D9701 22630-D9702
22630-71L00 22630-99B10 22630-00QA8
22630-0M200 22630-1W400 22630-44B20
22630-43Y00 22630-99B00
Ford 1 960 041 1 960 296 1 961 789
GM 93 180 124
Opel 44 15 176
Renault 22 63044 B20 7701 058 398

Facet 7.3225



NISSAN

Serena
Maxima
Cicra
Primera
200 SX
350 Z
Almera
Interstar
Pathfinder
Patrol GR II
Pick up
Sunny
Terrano
Trade
X-Trail

OPEL

Movano

RENAULT

Espace
Master
Vel Satis

FORD

Maverick
Infin Q45

02-W055301

OEM NO.

Application List

Ford E7GZ-10884-B
Mazda 8 569 18 510
Motorcraft SWE 2093
KIA KKY01-18-510

Facet 7.3068

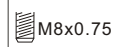

FORD IMPORT

Festiva/Tracer

MAZDA

B 2200
GLC
RX-7
323
626
929



02-W055401

OEM NO.

Application List

	Mitsubishi MC-850079 MC-843920 MD-050214 MD-005051	MITSUBISHI Colt Galant L200 L300 Lancer Pajero Space Gear Space Wagon		
	M16x1.5		17	

02

02-W055402

OEM NO.

Application List

	Mitsubishi MD-177572 MD-182467 Hyundai 39220-35710 Daihatsu 89422-87101-000 98422-87202-000 Volvo 30874182 Denso 179700-0240	DAIHATSU Cuore Domino Mira Move			MITSUBISHI Carisma Colt Colt Space Star ExpoLRV Galant Lancer Space Star	VOLVO S40 V40
	3/8-19 RC		19			

02-W055403

OEM NO.

Application List

	Mitsubishi MD-149338 GM 97036606 97069786 Opel 1341031 1341038 Hyundai 39220-35510 39220-35520 ISUZU 8-97036606-0 8-97069786-1 Kia 3922035510 3922035520	MITSUBISHI Colt Diamante Expo ExpoLRV Lancer Mirage Montero Pajero Pick-up Space Runner Space Wagon			HYUNDAI Truck 3000 GT Elantra Gallopel Lantral	OPEL Monterey Campo	KIA Joice
	3/8-19 RC		19		Facet 7.3144		

02-W055404

OEM NO.

Application List

	Suzuki 13650-64B00	SUZUKI Swift Swift DOHC		
	Facet 7.3226	M12x1.5		19

02-W066002

OEM NO.

Application List

 A Black B Green	KIA OK95B-18-840 OK011-18-840 OK054-18-84X K8574-18-840	KIA Pride Clarus Sephia Sportage		
	M12x1.5		19	

**02-W066001****OEM NO.****Application List**

KIA KK150-18-510A
KK150-18-510B
Daihatsu 83420-87702-000
ISUZU 5-86202-837-0
SUZUKI 34850-70B10

KIA

Pride

DAIHATSU

Appkayse
Charade
Cuore
Feroza F300

SUZUKI

SWIF II

1/8-28
BSP

4 mm

02**02-W066101****OEM NO.****Application List**

Daewoo 12191170
25036898
96181508
96182634

DAEWOO

Aranos
Espero
Evanda
Lanos
Leganza
Nexia
Nubira
Rezzo
Tacuma

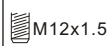

M12x1.5



19

**02-W066201****OEM NO.****Application List**

Hyundai 39220-38020

HYUNDAI

Accent
Coupe GK
Getz TB
Matrix FC

3/8-19
RC

19

**02-W066202****OEM NO.****Application List**

Hyundai 39230-26700
Kia 39220-38030

HYUNDAI

Coupe GK
Matrix FC
Xg25
Magentis

3/8-19
RC

19

**02-W066203****OEM NO.****Application List**

Hyundai 39220-02500
39220-02510
KIA 39220-38010

HYUNDAI

Elantra
Excel
Lantra
Pony
Precis
Scoupe
Sonata



19

**02-W077001****OEM NO.****Application List**

Fiat 4067572 4409505 4108672 4414600
4276954 4448131 4349082 7591297
4407984 7727854

FIAT

Cinquecento 704
124
125
126
127
131
132
Argenta
Barchetta
Brava
Cinquecento
Coupe
Croma

FIAT

Ducato
Duna
Florino
Marea
Palo
Panda
Punto
Regata
Ritmo
Seicento
Tempra
Tipo
UNO
X1-9

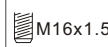

M16x1.5



**02-W077002****OEM NO.****Application List**

	Fiat 7548005 7588883			
	M16x1.5			

FIAT

Panda 750
Panda 1.0i Fire
Panda 1.1 i Fire
Panda 4x4 1.0
Tipo 1.1
Uno 45 1.0 Fire
Uno 45 1.0 Fire (DAV-15)
Uno 45 1.0 Fire S/SL

1986-91
1986-91
1986-91
1986-91
1988-91
1989-91
1989-91
1985-89

FIAT

Uno 45 1.0i Fire
Uno 60 1.1 Fire (1108cc)
Uno 60 1.1i Fire (1108cc)
Uno 1.0 iFire
Uno 1.0 iFire (USA'83)
Uno 1.1 iFire
Uno 1.1 iFire (USA'83)

1989-91
1989-91
1989-91
-> 1991
-> 1991
-> 1991
-> 1991

02**02-W077003****OEM NO.****Application List**

	Fiat 5108205			
	M22x1.5			

FIAT TRACTORS**02-W077004****OEM NO.****Application List**

	Fiat 7588856 7589337 82357865			
	M14x1.5		---	

FIAT

Coupe
Croma
Tipo

02-W077005**OEM NO.****Application List**

	Fiat 4171667 34362106 634362106			
	M16x1.5		---	

FIAT**SEAT****02-W077006****OEM NO.****Application List**

	FIAT			
	M18x1.5			

FIAT**02-W077007****OEM NO.****Application List**

	Fiat 4746856 4840434			
	M16x1.5			

IVECO

370
470
570
670
Bus 811
Bus 871



02-W077008

OEM NO.

Application List



Fiat 46474712
46474713
Alfa Romeo 60814402

Facet 33720

M12x1.5



FIAT

Barchetta Gasolina/Petrol
Barva Gasolina/Petrol
Barvo Gasolina/Petrol
Coupe Gasolina/Petrol
Palio Weekend
Punto Gasolina/Petrol
Siena

02

02-W077009

OEM NO.

Application List



Fiat 46414596
Jaeger 401930
GM 90 411 977

FAE 33760

M12x1.5





FIAT

Brava
Bravo
Marea
Palio
Siena
GTV
Spider

02-W077010

OEM NO.

Application List



Fiat 4824207
5969930
7762302

M16x1.5



115 °C



FIAT

Corma
Punto
Ducato
Talento Diesel

02-W099001

OEM NO.

Application List



Paykan

5/8-18
UNF



22



PAYKAN

02-W099002

OEM NO.

Application List



Paykan

5/8-18
UNF



22



PAYKAN

02-W099003

OEM NO.

Application List



Paykan

5/8-18
UNF



18

6.35 mm





PAYKAN

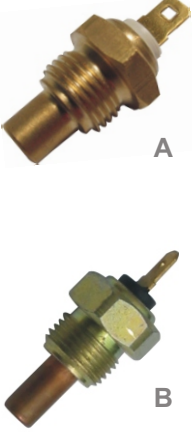

02-W00001

OEM NO.

Application List





	Volvo 460191 460191-0 Rover PRC4372	VOLVO 240 340-360 740 760		
	Facet 7.3029 FAE 31360	 5/8-18 UNF		 19

02

02-W00002

OEM NO.





Application List

	Volvo 9125463	VOLVO S60 C70 S40 S70 S80 V40 V70		
	Facet 7.3304 FAE 32425	 M12x1.5		 19

02-W100101

OEM NO.





Application List

	Lada 2101-38086000 2101-21082110 15TM106	LADA 1200-1500 1200-1600 NIVA 2121 SAMARA 2108,2109		
	 M16x1.5 con		 ---	

02-W100102

OEM NO.





Application List

	Lada TM104-3808000	LADA		
	 3/8-18 NPT		 19	 M4

02-W100103

OEM NO.

Application List

	Lada TM100-3808000 TM111-3808000-02	LADA Ja-31512		
	 3/8-18 NPT		 19	 6.35 mm



02-W100104

OEM NO.

Application List

02



Lada 19.3828000

LADA

 M12x1.5



 19





03-T011001

OEM NO.

Application List

	Mercedes	005 545 70 24	50°C
		006 545 70 24	50°C
		006 545 90 24	60°C
	M14x1.5		

Mercedes Benz	M.B.COMM.
190, 190E, 190D	208
200, 250 Diesel	210
300 D, TD 4Matic	308
E 250 Turbo D	310
	510

03-T011002

OEM NO.

Application List

	Mercedes	006 545 14 24	100°C
		006 545 39 24	100°C
	M14x1.5		

Mercedes Benz	M.B.COMM.
190, 190E, 190D	208
200, 250 Diesel	210
300 D, TD 4Matic	308
E 250 Turbo D	310
	510

03

03-T011003

OEM NO.

Application List

	Mercedes	006 545 15 24	100-95°C
		006 545 40 24	100-95°C
	M14x1.5		

MERCEDES
E200 Diesel
190, 190E, 190D
200 Diesel
200 Turbo D
230 E, CE, TE
300 GE 4X4
100 Bus D
Cabriocet 300
Coupe 230C, CE
Coupe 280C, CE
E-CLASS
G-CLASS
Kombi
S-class 260 SE
S-class 300
Saloon
Ti box
Ti bus

03-T011004

OEM NO.

Application List

	Mercedes	007 545 45 24	75-70°C
	M14x1.5		

MERCEDES
E200 Diesel
190, 190E, 190D
200 Diesel
200 Turbo D
230 E, CE, TE
300 GE 4X4
100 Bus D
Cabriocet 300
Coupe 230C, CE
Coupe 280C, CE
E-CLASS
G-CLASS
Kombi
S-class 260 SE
S-class 300
Saloon
Ti box
Ti bus

03-T011005

OEM NO.

Application List

	Mercedes	006 545 45 24	105-100°C
			115-105°C
		006 545 42 24	100-95°C
			107-97°C
		006 545 61 24	105-100°C
		006 545 64 24	120-115°C
			105-100°C
			120-115°C
	FEA	38120 38130 38140	
	M14x1.5		

Mercedes BENZ	Mercedes BENZ
250 Diesel	190
250 GD 4X4	G-CLASS
250 Turbo D	
300 CE	
300 E 4MATIC	
300 GD 4X4	
300 TE 4MATIC	
350 GD 4X4	
500 SE, SEC, SEL.	
190	
E-CLASS E250	
E-CLASS E300	
E 200 Diesel	
190 E	
200	

03-T011101

OEM NO.

Application List

	BMW	1378073	91-86°C
			99-94°C
		61 311 378 073	91-86°C
			99-94°C
		61 318 361 787	80-73°C
			88-81°C
	M14x1.5		

BMW	BMW CONT.
316i	324D, TD
318i, is, Touring, 16v	325E, I, Cabrio
318is	325i
320ic	518i
320i	520i, 525i
	530i, 535i
	524 TD
	730i, 735i, IL
	757i V12
	840 Ci
	850i, Ci, CSI
	M3, Coupe
	M5



03-T011102

OEM NO.

Application List



GM	100-95°C	92 045 312
Renault	100-95°C	77 00 739708
Volvo	100-95°C	1276229
		1276229-0
		3206773-8

BMW

320i 320iC 323i
324D, TD
325i, iC, iX
520i, 528i
524D, TDi
728, 728i, iS
730i, 732i, 733i
745i
M 535i



03-T011103

OEM NO.

Application List

03

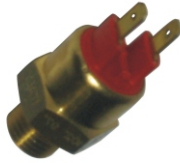

BMW	102-97°C	1 364 273
		61 311364 273

BMW

320i 320iC 323i
324D, TD
325i, iC, iX
520i, 528i
524D, TDi
728, 728i, iS
730i, 732i, 733i
745i
M 535i



03-T011104

OEM NO.

Application List



GM	90 192051	65°C
Opel	1239232	65°C

BMW

320i 320iC 323i
324D, TD
325i, iC, iX
520i, 528i
524D, TDi
728, 728i, iS
730i, 732i, 733i
745i
M 535i

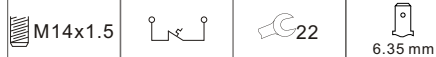

03-T011201

OEM NO.

Application List



Audi	823 959481F 823 959 481L 923 959 481A 923 959 481J 175 919 481 823 959 481G 823 959 481K 823 959481 823 959 481H 251 959 481	Ford	6077896 6077897 6077985 6104433 6104434 6104435 6115344 6120662 6120663 6132218 77FB8B607A 77FB8B607A2D 78FB8B607A 81AB8B607A3A D8 RZ 8B607 C
VW	96029641 5.435.033 95.632.734 95.492.854 5.463.397 5.190.542 96.015.494 95.493.258	G.M.	90087398 94121028 90108636
Citroen	1264.20 1264.21 1264.14 0242.10 0242.12 1264.04 1264.13	Renault	60 00 001 356 77 00 748 169 77 00 622 755
Opel	1341003 1341002 1341007 1341008		

AUDI

50
80
90
100
Coupe
Quattro, Sport, Quattro
4000
5000
Fox

VW

Derby
Golf
Jetta
Scirocco
Passat
Polo Classic, Coupe
Santana
Caddy
Type 2
Transport
Vanagon
Dsher
Quantum
Rabbit
LT

FORD

Escort (OHV, CVH) 1980-84
Escort 1.6 iXR3 i, Cabrio 1982-86
Escort RS Turbo 1984-86
Fiesta 1.0, 1.1, 1.3, XR2i 1976-83
Fiesta 1.0, 1.1. (OHV) 1983-86
Fiesta 1.3, 1.4, XR2. (CV) 1983-86
Granada 2.3, 2.8, 2.8 i. (CV) 1980-85
Orion 1.3, 1.6, 1.6 i. (CV) 1983-86
Sierra XR4 i 1982-85
Escort 1.0 (OHV) 1980-86
Escort (CHV) 1980-86
Escort 1.6 iXR3 i, Cabrio 1982-86
Fiesta 1.0, 1.1, 1.3. (OHV) 1976-83
Fiesta 1.0, 1.1. (OHV) 1983-86
Fiesta 1.3, 1.4, XR2. (OHV) 1983-86
Fiesta 1.6 XR2 (OHV) 1981-83
Escort 1.6 Diesel 1984-86
Fiesta 1.6 Diesel 1984-86
Orion 1.6 Diesel 1984-86
Granada A.A. (E) 1980-85
Granada Diesel 2.5 1980-85
Orion 1.3, 1.6, 1.6 i. (CV) 1983-86
Pinto 1.6 (USA) 1977-80
Sierra XR4 i 1982-85
Sierra 2.3 Diesel 1982-84
Escort 35, 55 Van 1985-86
Fiesta Van 1.0, 1.1 1976-89

CITROEN

CX 2000	1975-78
CX 2200	1975-76
CX 2.0, 2.2	1975-85
LNA 11 RE	1982-84
Visa Super, Super E	1978-81
Visa Crono 1.3	1982-87
Visa II	1984-89
Visa GT	1982-89
Visa 11	1984-89
AX 10, AX 11, AX 14	1987-89
AX GT, AX Sport	1987-89

OPEL

Ascona B, C	1975-88
Commodore B, C	1972-86
Corsa A 1.0, 1.2, 1.3	1982-87
Kadett D	1980-84
Kadett E	1984-88
Manta B	1975-88
Monza A 2.2, 2.5, 3.0	1981-87
Omega	1986-88
Senator A	1978-87
Senator B 2.5i, 3.0i	1987-88
Kadett 1.0	1980-84
Rekord E	1978-86
Senator A 2.3 TD	1978-87







03-T011202

OEM NO.

Application List

	Volkswagen 357 919 369E			
	Facet 7.4107			
∅ 20 mm		119-112°C		

SEAT

Ibiza
Audi A3
Ford Galaxy



VW

Corrado
Golf
Jetta
Passat
Transporter
VENTO

03-T011203

OEM NO.

Application List

	Volkswagen 09109661 119°C 191 919 369A 119°C 251 919 369B 55-65°C			
	GM 90 508084 120-115°C Opel 13 41045 120-115°C Mitsubishi M-809548 119°C Ford 7 355021 112°C Seat 95VW-8B607-EB 112°C 191 919 369A 119°C 251 919 369B 55-65°C			
∅ 20 mm		119°C 112°C 55-65°C 120-115°C		

VW

Corrado
Passat
LT
Golf/Jetta D,TD
Lupo
New Beetle
Passat
Polo
Vento D
Opel Arena
Megane
Scirocco
Caddy

VW COMM.

Transporter
Caravelle
Transporter
Transporter Digifant

SEAT

Alhambra
Cordoba
Ibiza
Toledo

MITSUBISHI

Carisma

AUDI

A3
S3
TT
A6

OPEL

Vectra B

FORD

Galaaxy

SKODA





Octavia

03

03-T011204

OEM NO.

Application List

	AUDI-SEAT-VW 95-85°C 191 959 481C 102-92°C 251 919 481C 251 919 481D 321 959 481A 321 959 481C 321 959 481D			
	Porsche 951 606481 00 Volvo 34489161 34512160			
	Seat 88-79°C SE-023952600A 110-102°C			
	FAE 37840 38150			
				
	M22x1.5		29 95-85°C 102-92°C	

AUDI

80/100
90/200
A3
A4
A6
A8
Coupe
S4
S6

VOLKSWAGEN

Caddy
Corrado
Golf/Jetta/Scirocco
Golf/Vento
Passat
Polo, Classic, Coupe
Caravelle
Transporter
Type 2

SEAT

Ibiza
Ibiza II
Malaga
Cordoba/Ibiza
Inca
Toledo

SKODA

Felicia
Pick-up



VOLVO

Series440 460 480

03-T011205

OEM NO.

Application List

	VW 95-90°C 140 959 481B 102-97°C			
	VW/Audi 1H0 959 481B Ford 721 5818 95 VW 959 481B			
	VW 90-80°C 1H0 959 481 97-87°C 1H0 959 481C			
	M22x1.5		29	

VOLKSWAGEN

Golf
Lupo
New Beetle
Passat
Polo
Vento

AUDI

A3
TT

FORD

Galaxy

SEAT

Alhambra
Arosa
Cordoba
Ibiza
Inca
Leon



03-T011206 OEM NO. Application List

	Seat/Skoda/VW 95-90°C 867 959 481			AUDI A3 SEAT Arosa Leon Toledo II SKODA Octavia Octavia RS	VOLKSWAGEN Bora Golf II Golf III Golf IV Jetta II Lupo Passat Polo Vento
	M22x1.5				

03



03-T011207 OEM NO. Application List

	Audi/VW 95-90°C 811 959481 893 959 481			AUDI 80 90 100 200 A4,Avant,Quattro A8 Cabriolet Coupe,Coupe Quattro S4
	M22x1.5			

03-T011208 OEM NO. Application List

	Audi-seat-VW 65°C 035 919 369C			AUDI 80 100 Coupe SEAT Toledo VOLKSWAGEN Derby Golf Passat Passat/Santana Polo Coupe Polo Scirocco Carb. VW COMM. Caddy Transporter
	M10x1.0			

03-T011209 OEM NO. Application List

 A  B	Audi-VW 95-90°C 307 959 481 1 321 959 481 B 321 959 481 E 321 959 481 G Seat 88-79°C SE-021952600B 92-87°C SE-021952600A Volvo 92-87°C 3416584-5			AUDI 4000 SEAT Cordoba Ibiza Inca Toledo Terra 1300Diesel Terra 1400Diesel Malaga Ibiza Marbella VOLKSWAGEN Derby Golf/Jetta/Scirocco Golf/Vento Passat/Santana Passat Polo Classic,Coupe Quantum Rabbit Vento Caddy Golf Van Transporter Type 2 VOLVO 440 460 480 FIAT Brava Cinquecento Cucato Duna Florino Danda Punto Pegato Talento Tempra Tipo Uno
	M22x1.5			

03-T011210 OEM NO. Application List





	Seat/Audi/VW/Skoda 053 919 501A			AUDI 80 100 Coupe A6
	∅20mm		120°C	

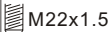

03-T011211

OEM NO.





Application List

	Audi/VW 87-76°C 251 959 481G 93-82°C 251 959 481K 251 959 481H		VW COMM.	AUDI
	FAE 37950		Caravelle Transporter	AUDI A8
				

03-T011212

OEM NO.

Application List





	Volkswagen 8D095 481B		AUDI	VOLKSWAGE
	FAE 38391		A2 A4 A6 A8	Passat Passat Variant
		95-90°C 102-97°C		

03

03-T011301

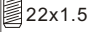
OEM NO.





Application List

	Opel 105-100°C 1846201 120-115°C		OPEL
	GM 90482428		Corsa Tigra
			

03-T011302

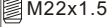
OEM NO.







Application List

	Opel 90-82°C 1341028 82-68°C 1341021		FIAT	FIAT COMM.	OPEL	VAUXHALL
	GM 87-82°C 90357303 97-92°C 90307873		Regata Ritmo	Ducato	Astra Calibra Vectra	Astra Calibra Vectra
Fiat 90-82°C 7586250 97-92°C 7570837 97-92°C 46520219						

03-T011303

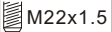
OEM NO.

Application List

 A 95-90°C 120-115°C	Opel 1846326 ----- A 1846341 ----- B 1846324 ----- C		OPEL
	GM 90357304 ----- A 90492454 ----- B 90339414 ----- C		Calibra Omega B Carlton
 B 100-95°C 120-115°C	C 110-105°C 120-115°C		
FAE 38235 38230			
			



03-T011304

OEM NO.

Application List



A
88-83°C
95-90°C

B
95-90°C
105-100°C

C
100-95°C
110-105°C

D
92-87°C
101-96°C

Eith 268112 ----- A
GM 90341759 --- A
90355880 --- B
90339409 --- B
90355879 --- C
90339408 --- C

Opel 1341033 --- A
1341039 --- B
1341026 --- B
1341027 --- C
1341025 --- C

VOLVO 3463731-4 --- D
3463711 --- D

FAE 38210
38240

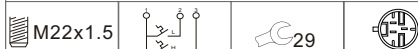

OPEL	VOLVO	VAUXHALL
Calibra Vectra	Serie 440 460 480	Calibra Vectra Astra Calibra Frontera Omega Sintra Zafira

03

03-T011305

OEM NO.

Application List



Opel 100-95°C 90339500
GM 1341023
90339500

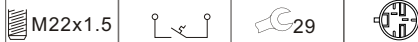

OPEL
Calibra
Vectra
Cavalier MK

03-T011306

OEM NO.

Application List



Opel 100-95°C 1341030
GM 90449435



OPEL
Astra 1.4 i (14NV, 14SE) 1991-98
Astra 1.4 i Cat. (C14NZ, 3B) 1992-98
Astra 1.6 i (X16SZ, SZR) 1991-98
Astra 1.6 i Cat. (C16NZ, 3B) 1992-98
Astra 1.6 i 16V 1994-98
Astra 1.8 i Cat. (C18NZ) 1991-94
Corsa 1.5 Diesel (4EC1) 1993- >
Corsa 1.7 D Combo 1993- >

03-T022001

OEM NO.

Application List



Renault 77-67°C 60 01 023839
92-82°C 77 00 782503
Opel 92-82°C 44 02 309
GM 09 110 309



OPEL	RENAULT Cont.
ARENA 1.9 D 1998-01	R-11 1987-88
ARENA 2.5 D 1998-01	R-19 1988-97
MOVANO 1.9 DTI 2000-01	R-21 1988-93
MOVANO 2.5 D 1999- >	R-25 1987-92
MOVANO 2.8 DTI 1998-01	Safrane 2.0 i, Si. (J7R) 1992-97
RENAULT	Safrane 2.1 DT (J8S) 1992-97
Clio 1990-96	Scenic 1996- >
Clio 1.9 D, TD 1990- >	Twingo 1993- >
Espace 2.0, 2.0 i, 2.2 i 1987-90	RENAULT COMM.
Espace 1997- >	Express
Laguna 1994- >	Express 1.1, 1.2, 1.4
Megane, Classic, Cabriolet 1996- >	Express 1.2 e, 1.4 e
Megane Break 1999- >	Express 1.6 D, 1.9 D
Super 5 1987-90	Kangoo 1.9 D (F8Q) 1997- >
	Master 2.5 Diesel (S8U) 1998- >
	Master 2.8 DTI (S9W) 1998- >
	Trafic 1989- >

03-T022002

OEM NO.

Application List



Renault 92-82°C 77 00 809773
100-95°C



RENAULT
R-19 TD, GTD. (F8Q) 1989-92
R-19 1.9 Diesel (F8Q) 1992-97
R-19 TBD (F8Q) 1990-92
R-19 1.9 Turbo D (F8Q) 1992-97





03-T022003 OEM NO. Application List



Renault	87-77°C	77 00 839072
	92-82°C	77 01 036113
		77 00 421969
		77 01 040964
GM		91 61054
OPEL		45 00754

M22x1.5

RENAULT		RENAULT	
Clio Automatics	1990- >	Master 2.5 Diesel (SBU)	1998- >
Espace	1997- >	Master 2.8 DTI (S9W)	1998- >
Espace Automatics	1991- >		
Laguna	1994- >		
Megane	1996- >		
R-19 Automatics	1988-92		
R-25 Automatics	1992-97		
Safrane Automatics	1992- >		
Scenic	1996- >		

03-T022101 OEM NO. Application List



Peugeot	65-60°C	1264.28
---------	---------	---------

M22x1.5



65-60°C



PEUGEOT	
Peugeot 405	

03

03-T022102 OEM NO. Application List





Citroen	96.064.750	-----	A
	96.085.909	-----	B
	95.638.684	-----	C
	1264.36	-----	C
Peugeot	1264.44	-----	C
	1264.25	-----	A
	1264.38	-----	A
	1264.45	-----	A
	1264.27	-----	B
	1264.24	-----	C
	1264.36	-----	C
	90.458.540	-----	B
GM	90.492.455	-----	B

A
97-92°C
101-96°C

B
84-79°C
88-83°C

C
92-87°C
97-92°C

M22x1.5



CITROEN		PEUGEOT COMM.	
AX 15 D, TD	1994- >	Expert 1.9 TD	1996- >
Berlingo 1.8 D, 1.9 D	1996- >	Partner 1.7 D, 1.9 D	1996-97
Evasion 2.0 iTurbo	1994- >	Ranch 1.7 D, 1.9 D	1996- >
Saxo Diesel	1997- >	106	1996- >
Saxo 1.6 i16V VTS	1997- >	205	1990-93
Xantia	1993- >	206 1.9 Diesel (DW8)	1998- >
XSara 1.8 iExclusive	1997- >	306	1993- >
XM	1992- >	309	1990-93
ZX	1993- >	405	1990-96
		406	1996- >
		605	1990- >
		806 2.0 iTurbo	1994- >

03-T022103 OEM NO. Application List



Citroen	97-92°C	96.064.561	-----	A
	97-92°C	96.064.503	-----	B
	95-86°C	96.009.503	-----	C
	92-87°C	93.123.564	-----	C
Peugeot	92-87°C	93.138.637	-----	C
	92-87°C	1264.43	-----	C
	95°C	1264.29	-----	A
	97-92°C	1264.26	-----	A
	95-86°C	1264.23	-----	A
	92-87°C	1264.31	-----	A
	92-87°C	1264.43	-----	A
	92-87°C	1264.43	-----	A

M22x1.5

CITROEN		PEUGEOT	
AX 11, AX 14, AX GTI	1991- >	106	1991- >
AX 14 D (PR.4860-5117)	1990-91	205	1989-93
Evasion 1.8 i, 2.0i X, SX	1994- >	306	1993- >
Saxo	1996- >	309 1.1 i, 1.3 i, 1.7 TD	1989-93
Xantia except Diesel	1993-97	405 Gasolina / Petrol	1990-93
XSara	1997- >	406 1.6 i, 1.8 i, 16V	1996- >
XM 2.0 Diesel	1989-91	806 1.8 i, 2.0 i, 16V	1994- >
ZX Gasolina / Petrol	1991-96	Expert Gasolina / Petrol	1996- >
ZX 1.9 Diesel	1991-92	Partner Gasolina / Petrol	1996- >

CITROEN COMM.

Berlingo 1.1 i, 1.4 i, 1.8 i 1996- >



Jumpy 1580 SPI 1995- >

03-T022104 OEM NO. Application List



Citroen	95-85°C	95.495.385	-----	A
	102-87°C	95.576.325	-----	B
		95.612.640	-----	B
Peugeot	93-88°C	91.517.674	-----	A
	97-92°C	96.019.305	-----	A
		1264.18	-----	A
	84-79°C	95.516.467	-----	A
Renault	97-92°C	60.01.008.060	-----	A
	101-96°C		-----	A

M22x1.5





CITROEN		PEUGEOT	
BX 16, BX 19	1983-93	305 1.3, 1.5	1983-87
BX 19 GTI	1986-93	305 1.6 GT	1983-88
BX 19 Diesel, Turbo D	1983-89	305 Diesel 1.7, 1.9	1979-88
C 15 D 1769 cc.	1993-96	309 1.6, 1.9	1986-87
CX 2.0, 2.2	1985-89	309 Diesel 1.7, 1.9	1986-87
CX 2.5 IE, GTI, TRI, RI	1985-89	505 GTI, STI, Injection	1984-87
CX 2.5 FTI Turbo, Turbo 2	1985-89	505 Turbo	1986-91
CX 2.5 Diesel, DI Turbo	1985-89	505 Diesel, Turbo D	1986-91
Visa Diesel	1984-86	604 Turbo D, GRD, SRD	1984-87



03-T033001

OEM NO.

Application List

	Ford 120°C	C8GY-10884A D1FZ-10884A E43Z-10884A D6AZ-10884A
	 3/8-18 NPT	  21  M4





FORD

Ford L4,L6
Ford Truck
Lincoln
Mercury

03-T033002

OEM NO.

Application List

	Ford 95-90°C 110-95°C	6154134 70001605 87BB8B607AA 87BB8B607AB
	95-90°C 100-95°C	6190785 6190786 7001606 89BB8B607DA 89BB8B607DB
 M22x1.5		 29 

FORD

Escort 1.4, 1.6 (CVH) 1990-95
Escort 1.4 iEFI 1995- >
Escort XR3i, Cabriolet 1990-95
Escort RS Turbo (CVH) 1990-95
Fiesta 1.4 CLX, CTX. (CVH) 1990-95
Fiesta 1.6 S, XR2i. (CVH) 1990-95
Orion 1.4, 1.6. L, GL, Ghia 1990- >
Orion 1.6 iEFI (CVH) 1990- >





FORD Cont.

Shaphire RS Cosworth 1988-90
Scorpio 2.0, 2.0 i. (OHC) 1985-92
Sierra 1.6, 1.8, 2.0 1985-93
Sierra 1.8 Automatic 1986-90
Sierra Cosworth 1988-93
Transit 1.6, 2.0. (OHC) 1985-92
Motores/Engines DL20H1 1985-92

03-T033003

OEM NO.

Application List

	Ford 102-97°C	1652990 6142676 6146107 6169111 6169112 6186463 6186464 85GB8B607B1A
	100-95°C	7001612 92FB-8B607-AB
 M22x1.5		 29 

FORD

Escort 1.1, 1.3, 1.3 i 1988-95
Escort 1.6 i 16V, 1.8 i 16V 1995- >
Fiesta 1989-95
Fiesta 1.1 i, 1.3i, 1.4 i 1992-95
Orion 1.3 CL (HCS) 1988-93
Scorpio 2.4 i, 2.9 i. (V6) 1989-95
Sierra 1.8 (CVH) 1988-93
Sierra 2.0, 2.3. (V6) 1985-87
Sierra XR4i. XR 4x4 1985-93





FORD COMM.

Courier 1.3 1991- >
Fiesta Van 1.0, 1.1 1989- >

03-T033004

OEM NO.

Application List

	Ford 80-75°C	61 55 859 86AB-8B607-AA
	 3/8-18 NPT	  25 





FORD

Escort 1.4 (CVH/HL14) 1986-87
Fiesta 1.4 (CVH/HL14) 1986-87
Orion 1.4 (CVH/HL14) 1986-87

03-T033005

OEM NO.

Application List





	Ford 96-83°C	E43F8B607AA E43Z8B607A
	 1/2-14 NPT	  25 

FORD

03-T033006

OEM NO.

Application List

	Ford 47°C 113°C	81864650 1864653
	 M14x1.5	  22 

FORD



03-T033101

OEM NO.

Application List

	GM 110°C	1993409 25036982 6490440 6490469 6490555			GM Buick Cadillac Chevrolet GMC Oldsmobile Saab Chevrolet GM HD Trucks GM Light Trucks
	119-130°C	1993351 1993369 6402186	1993564 25036503 1993462	1994095 6400092	
	Standard TS-25				

03-T033102

OEM NO.

Application List

	GM 115-110°C	3040674 3053247 3090289 14043275			G.M. Buick 1982-83 Cadillac 1986- > Chevrolet 1986-92 Oldsmobile 1986- > Pontiac 1987-92
	Buick	10045782			
	Standard TS-25				

03

03-T033103

OEM NO.

Application List

	GM	1993303 1993316 1993444 1993350 1993521 1993559 1998140	1998189 2854562 6400006 6400211 6402372 1993581		GM Buick Chevrolet GMC Oldsmobile Pontiac
	Standard TS-25				
			55°C 110°C		

03-T033104

OEM NO.

Application List

	GM 128°C	25036035 25036136 25036300 8992347 25036371 25036468	25036452 25036535 25037175 25037176 8993427 25036042		G.M. Buick 1982-87 Chevrolet 1982-87 GM Light Trucks 1982-90 Oldsmobile 1982-88 Pontiac 1982-86
	AMC	8933001542			
	Standard TS-25				

03-T033201

OEM NO.

Application List

	Chrysler 97°C	19021185 42212284			CHRYSLER
	95-90°C	19021008 5209923			
	Standard TS-25				

03-T055001

OEM NO.

Application List

	Toyota 85-80°C	89428-10090 89428-10100 89428-10110			TOYOTA Carina Van ET176V (3E) 1988-92 Celica 1.6 i (4AFE) 1991-93 Corolla 1.3 (2E, 3E, 1N) 1985-93 Corolla 1.3 (EE100-2E) 1992- > Corolla 1.3 XL (EE90) 1987-93 Corolla 1.8 i GTi (7AFE) 1992- > Corolla Wagon (2E, 3E) 1987-92 Corona Van ET176V (3E) 1987-92	
	85-90°C	89428-20060				TOYOTA Cont. Corsa 1.5 (EL31 3E) 1986- > Paseo 1.5 i 16V (5SFE) 1992-95 Sprinter 1.3 (EE80 2E) 1985-87 Sprinter 1.3 (EE90 2E) 1987- > Starlet 1.0 (EP70, 80) 1984- > Starlet 1.0 Turbo (2E, 1N) 1985- > Starlet 11.3 i, Turbo. (2E) 1985- > Tercel 1.3, 1.5, (2E) 1986-90 Tercel 1.51 (3E) 1992- > Treno EE90 (2E) 1987- >
	Facet 7.5095 FAE 36160					



03-T055002		OEM NO.		Application List	
	GM 90-85°C	94 846 018		TOYOTA	TOYOTA Cont.
		94 840 250		Camry 1.8, 2.0, 2.2 4cyl	Sprinter 1.5 (3A)
	Toyota 90-85°C	89428-15011		Camry 2.0 GLI (ST141)	Sprinter 1.6 (4A)
		89428-32010		Camry 2.5 V6, 3.0 V6	Sprinter 1.6, 1.6 i, Carib
	92-87°C	89428-10031		Camry Diesel	Sprinter 1.6 i 16V (4AGE)
	97-92°C	89428-10050	Facet 7.5070	Carina 1.5 (3A)	Sprinter 1.8 Diesel
Daihatsu		89428-10050-000	FAE 37660	Carina 1.6 (FWD)	Tercel 1.3 (FWD)
	M16x1.5			17	

03

03-T055003		OEM NO.		Application List	
	Toyota 95-90°C	89428-30030		TOYOTA	
	90-85°C	89428-15010		Corolla	
		89428-10030		Tercel	
				Starlet Kp60	
	M16x1.5			17	

03-T055004		OEM NO.		Application List	
	Toyota 90-85°C	89428-15020		LEXUS	TOYOTA Cont.
		89428-15030		LC400 4.0i V8	MR2 1.6 Injection DOHQ
				SC400 4.0i V8	MR2 2.0 i (3SFE, 3SGE)
				TOYOTA	MR2 2.0 Turbo (3SGTE)
				Camry 2.0 Turbo D	MR2 2.2 i (5SFE)
				Carina 2.0 Diesel	MR2 2.0 i (AL25G)
				Celica 2.0 i Turbo DOHQ	Sprinter 1.5 (AL25G)
				Celica 2.0 (5SFE)	Tercel 1.3 (FWD)
				Corolla 1.8 Diesel (1CLQ)	Tercel
				Corolla 1.8 Diesel (EU)	Tercel Station Wagon
				Corona 2.0 i DOHC	
				Corona 2.0 Diesel	
	M16x1.5			19	

03-T055005		OEM NO.		Application List	
	GM 92-87°C	94 853 091		TOYOTA	
	Toyota	89428-12150		Celica 1.6 i (4AFE)	1991-93
		89428-12160		Celica 1.8 i (7AFE)	1993->
	Facet 7.5198			Corolla 1.6 i (4AFE)	1992->
	FAE 36710			Corolla 1.8 i (7AFE)	1992->
				Paseo 1.5 i 16V (5EFE)	1992->
				Tercel 1.5 i (3EE)	1992->
				Starlet	
				Corolla	
				Paseo	
	M16x1.5			17	

03-T055006		OEM NO.		Application List	
	Toyota 105-100°C	89428-20020		LEXUS	TOYOTA
				Lc400	Camry
				Sc400	Carina
					Celica
					Corolla
					Corona
					Mr2
					Sprinter
					Tercel
					Tercel stationwagon
	M16x1.5			19	

03-T055007		OEM NO.		Application List	
	Toyota 97-92°C	89428-24010		TOYOTA	
	95-90°C	89428-33020		Supra 3.0 i (2JZGTE)	1993->
				Supra 3.0 i TB (USA)	1993->
	M16x1.5			21	



03-T055008

OEM NO.

Application List

	Toyota 105-100°C 89427-14070 Mazda 97-92°C PN41-18-840			
	M16x1.5			

TOYOTA	MAZDA
Pick-up	RX-7

03-T055009

OEM NO.

Application List

	Toyota 75-70°C 89427-12040 89427-12051			
	Facet 7.5269 FAE 37730	3/8-19 BPS		

TOYOTA
Carina CA6/SA60. (1C) 1979-84 Carina CA67 (1C) 1984-86 Carina 20 D CT150 (2C) 1982-85 Carina E D, TD 1996- > Corolla CE70/71/72 1981-85 Corolla KE70/73 1981-85 Corolla 1.8 DCE80 (1C) 1983-85 Hi-Ace 1.8 RH23/33 1981-82 Hi-Ace (3Y) 1982-88

03

03-T055101

OEM NO.

Application List

	Honda 92-87°C 37760-611-005 37760-634-005 37760-PA0-001 37760-PA0-003 37760-PB2-003			
	Rover Group BNP1883 Suzuki 17680-70020 17680-78000	M16x1.5		

HONDA	NISSAN	SUZUKI
Accord 1600, 1800 Accord 1300, 1500 Civic Integra Jazz/city 1231 cc Jazz/city 45,56 Prelude 1600 cc. Coupe, Quint	Bluebird 160B, 180B Bluebird 1.6GL, 1.8GL Cherry Langley Micra Silvia	Alto 350,550,FX,796 800 Cervo Cultus Fronte Sprint
HONDA CONT.	NISSAN CONT.	
Quint SV TN-Acty Van, Pick-up Tody Vigor 1600, 1800	210 280 ZX 310 510	

03-T055102

OEM NO.

Application List

	Honda 95-90°C 37760-P00-003 37760-P00-004 37760-PLZ-E01 112-107°C 37773-PT3-A01			
	Isuzu 95-90°C 5-86202-839-0 112-107°C 5-86202-840-0	M18x1.5		

ACURA	HONDA	ROVER
Integra odyssey Vigor	Accord Civic Prelude	618 620 623

03-T055103

OEM NO.

Application List

	Honda 92-87°C 37773-PH1-003 37773-PH1-621 37773-PH2-004 95-90°C 37773-P13-004			
	Mazda 92-87°C PEJ100080	M16x1.5		

HONDA	ROVER
Accord Prelude Vigor Civiciv IV	618 620 623

03-T055104

OEM NO.

Application List

	Honda 109-104°C 37760-PJ0-A01 37760-PJ0-661 37760-PR4-A01 92-77°C 37770-PY3-A01			
	Facet 7.5158 FAE 36430	M16x1.5		





HONDA
Integra Legend II

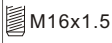

03-T055201

OEM NO.

Application List

	Nissan	95-90°C	21595-60A00
		92°C ON	21595-06B00
		102-97°C	21595-64A00
		100-95°C	21595-74Y10
		95-85°C	21595-63A00
		87-82°C	21595-07F00
			21595-63A01
	Facet	7.5055	7.5178 FAE 37770
	M16x1.5		 22
			





NISSAN

Langley 1.5 (E15S)	1986-88
Langley Turbo (E15T)	1986-88
Pulsar E16 (USA)	1987-88
Sentra E16 i, E16S. (USA)	1986-88
Sunny (N13) 1.0 (E10S)	1986-88
Sunny (N13) 1.3 (E13S)	1986-90
Sunny (N13) 1.5 (E15S)	1986-88
Sunny (N13) 1.6 (E16S)	1986-88

03-T055202

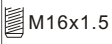
OEM NO.

Application List

	Nissan	102-97°C	21595-02E00
			21595-D4000
		87-97°C	21595-D3000
	Facet	7.5066	FAE 37520
	M16x1.5		 22
			

NISSAN





Auster (T12)	1985-86
Bulebird (T12, T72)	1986-90
Bulebird (A.A.)	1988-92
Maxima (USA)	1984-94
Stanza 1.6, 1.8	1986-87

03

03-T055203

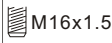
OEM NO.

Application List

	Nissan	92-87°C	21595-04R00
	M16x1.5		 27
			





NISSAN

Prairie

03-T055204

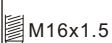
OEM NO.

Application List





	Nissan	95-90°C	21595-05A00
	M16x1.5		 22
			

NISSAN

03-T055205

OEM NO.

Application List

	Nissan	60-65°C	21595-N4700
			21595-P7100
			21595-02P00
			21595-P8100
			21595-P8200
	Isuzu		8-94483-1551-0
			8-97068-804-0
	GM		97068804
	3/8 GAS		 19
			 4 mm





NISSAN

Trooper II Diesel
Jackaroo
Rodeo

03-T055206

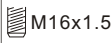
OEM NO.

Application List

	Nissan	90-85°C	21595-01A00
			21595-04A00
	Mitsubishi	85-80°C	MB-605079
	M16x1.5		 22
			

NISSAN





NISSAN		NISSAN Cont.	
310 1488 cc. (USA)	1985-91	Prairie 1.8	1983-84
AD 1.3, 1.5, 1.7 D	1982->	Pulsar 1.3, 1.5, Turbo	1986-91
Cherry (N12)	1982-86	Pulsar 1.7 Diesel	1991->
Langley 1.5, Turbo	1982-84	Sentra (USA)	1991-94
Langley 1.7 D (CD17)	1983-84	Sunny (B11) 1.3, 1.5	1992->
Liberta 1.5, Turbo	1982-87	Sunny 1.5 Turbo (E15ET)	1992-94
Liberta 1.7 Diesel	1983-87	Sunny 1.7 D (CD17)	1992-93
Prairie 1.5 (E15S)	1982-85	Sunny California	1993->



03-T055301

OEM NO.





Application List

	Mazda 90-85°C B6S7 18 840 97-92°C N350 18 840	MAZDA	121 232 323 626 Miata MX-3 MX-5 MX-6
	KIA 90-85°C K201-18-840 97-92°C On35018840		
	Facet 7.5189 7.5205		
 M16x1.5		 17	

03-T055302

OEM NO.

Application List



	Ford 97-92°C E7 R4 10884A E7 RY 10884A E8 BZ 10884A F1 JY 10884A	FORD USA	MAZDA
	Mazda 97-92°C B303-18-840 E301-18-840A F8B8-18-840 F8B8-18-840A		
	90-85°C BJO1-18-840 E508-18-840A F8B5-18-840		121 323 626 929 E 1800,2000 GLC Hatchback MX-6 RX7,Coupe
	Facet 7.5069 FAE 37610		
 M16x1.5		 17	 6.35 mm

03

03-T055303

OEM NO.





Application List

	Mazda 15.5°C E565-18-840	MAZDA
 3/8-18		 21
		 4 mm

03-T055304

OEM NO.





Application List

	Mazda 36°C RF03-18-840	MAZDA
 M10x1.5		 14
		 6.35 mm

03-T055305

OEM NO.





Application List

	Mazda 10°C HE01-18-840	MAZDA
 3/8-18		

03-T055401

OEM NO.

Application List

	Mitsubishi 85-80°C MB-007639 100-95°C MB-435745	MITSUBISHI	MITSUBISHI Cont.
	Denso 100-95°C 071400-3350		
 M16x1.5		 17	 6.35 mm

Chariot 1983- >	Lancer 1200, 1400, 1600 1972-84
Colt 1200, 1400, 1600 1978-85	Lancer 1.3, 1.5, Van 1983-90
Colt 1400, 1600, Turbo 1986-90	Lancer 1.6 Turbo 1983-87
Conquest 1984- >	Lancer 2000 Turbo 1981-90
Cordia 1600 GSL, Turbo 1982-86	Lancer 1800 Diesel, Van 1983-91
Cordia 1800, 2000, (USA) 1982-86	Mirage 1982-89
Galant 1600 1985-87	Saga 1985- >
Galant 2000 Turbo, EX 1982-88	Sapporo 2000, Turbo 1979-84
Galant Diesel 1980- >	Station 2000 Turbo, 2600 1982-85



03-T055402 **OEM NO.** **Application List**

	Mitsubishi 85-80°C MB-356704	MITSUBISHI		
	Facet 7.5109	Mirage		
	M16x1.5			

03-T055403 **OEM NO.** **Application List**

03

	Mitsubishi 85-80°C MB-660663 MB-845063	MITSUBISHI		
	95-90°C MB-660664	MITSUBISHI Cont. Colt 1.3 i GLI (4G13) 1993- > Colt 1.6 i, 4WD. (4G92) 1992- > Colt 2.0 Diesel (4D68) 1992- > Diamante 3.0 i, Wagon 1991- > Eclipse 1.8 i (4G37) 1988- > Eclipse 2.0 i, TB, 4WD 1989- > Eterna (4G37, 4G63, 65) 1988- > Expo 2.4 i (4G64) 1991- > MITSUBISHI Cont. Expo LRV 1.8 i, 2.4 i 1991- > Galant 2.0 i, TB, 4WD. (4G63) 1988-93 Lancer 1988-91 Lancer 1.3 i GLI (4G13) 1993- > Lancer 1.6 i, 4WD. (4G92) 1992- > Lancer 2.0 Diesel (4D68) 1992- > Mirage 1987-91 Mirage 1.5 i, 1.8 i. (USA) 1992- > Space Runner 1.8 i 16V Space Runner Turbo D Space Wagon 1.8 i 16V Space Wagon 2.0 i 16V Space Wagon 2.4 i Space Wagon Turbo D 3000 GT 3.0 i V6, Turbo		
	Facet 7.5173	M16x1.5		

03-T055404 **OEM NO.** **Application List**

	Mitsubishi 115-110°C MD-142766	MITSUBISHI		
	3/8BPS 19 h con.			
	6.35 mm			

03-T055405 **OEM NO.** **Application List**

	Mitsubishi 97-92°C MD-102329	MITSUBISHI		
	1/8-27 NPT			
	6.35 mm			

03-T055406 **OEM NO.** **Application List**

	Suzuki 87-82°C 17680-84000 17680-84201 17680-84201-000	MARUTI		
	Facet 7.5199 FAE 36240	800 E01,E02		
	M16x1.5			





SUZUKI-SANTANA	
Alto	
Cervo	
Fronte	
Maruti	
Might Boy	
Vitar	

03-T055407 **OEM NO.** **Application List**



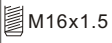



	Suzuki 85-80°C 17680-82020 17680-82030	SUZUKI		
	Nissan 90-83°C 21595-01B00 21595-03B60 21595-38E00	NISSAN		
	M16x1.5			

NISSAN	
March	
Micra	



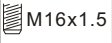

**03-T055408****OEM NO.****Application List**

	GM 102-97°C 96 060 144 96 065 484 100-95°C 96 060 143 96 063 056 96 065 661	17680-60B20 17680-60B10	SUZUKI			
	Suzuki 102-97°C 17600-70830 100-95°C 17600-70821 17680-70B10		17680-60B20 17680-60B10	SWIFT		
	Facet 7.5172 7.5148					





03-T055409**OEM NO.****Application List**

 A	Suzuki 90-85°C 17680-82001 17680-82011	17680-82011 96051827 96055554	SUZUKI		GM	
	GM			Alto Cervo Fronte Maruti M-800 Might boy Vitara Swift Sa413		Sprint Sprint Turbo
 B						



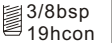

03**03-T055410****OEM NO.****Application List**

	GM 100-95°C 96065719	17680-50F10 17680-50F00	SUZUKI			
	Suzuki 100-95°C 96065719 95-90°C 17680-50F00		Swift			
	Facet 7.5186 7.5282					

03-T055411**OEM NO.****Application List**

	Daihatsu 92-87°C 83430-87701	83430-87701-000 553321201 6553321201	DAIHATSU		INNOSENTI	
	Innocenti			Charade Cuore Domino FellowMAX		Mini S,SE,SL Mini Turbo
						

03-T055412**OEM NO.****Application List**





	Daihatsu 72°C-OFF 83430-87719-000	DAIHATSU				
		Small 990				
	Facet 7.5256					



03-T066001

OEM NO.





Application List

	KIA 91-86°C KK150-18-840 75-70°C KK150-18-840A			KIA Pride
	 M16x1.5		 17	 6.35 mm

03-T066002

OEM NO.

Application List





	KIA 91-86°C OK201-18-840 OK201-18-840A			KIA Sephia
	 M16x1.5		 21	

03

03-T066003

OEM NO.





Application List

	KIA 30-25°C OPN11-18-840 60-55°C KF621-18-840 72-67°C OF823-18-840 17°C OFF OE357-18-840 17°C ON KKY01-18-840			KIA Jumbo titan Wide Bongo Frontier
	 3/8x19		 21	 4 mm

03-T066101

OEM NO.





Application List

	Daewoo 105-100°C 2169005010			DAEWOO Musso
	 M16x1.5		 19	

03-T066201

OEM NO.





Application List

	Hyundai 110-105°C 25360-29107 85-80°C 25360-37200			HYUNDAI Lantra II
	Facet 7.5274 7.5278			
 M16x1.5		 24		

03-T066202

OEM NO.

Application List





	Hyundai 100-95°C 93920-37100 90-85°C 25360-M2002 85-80°C 25360-37100			HYUNDAI
	KIA 100-95°C 25361-M2000			KIA Joice
FAE 36485 Facet 7.5246				
 M16x1.5		 21		



03-T077001

OEM NO.

Application List

	Fiat 92-87°C	4402824	4413840	4413842
		3934328	4478950	4478951
		4478952	5951985	5951987
		3939836		
Seat		HA-952600.00		
		HA-952600.01		
		HH-952600.00		
		HH-952600.01		
	M22x1.5			





FIAT

127 903-1050 cc., Sport 977-83
 128 1116-1290, Coupel 926-82
 131 1976-85
 132 1977-82
 238 A, B, B1, E 1978-81
 242, E 1976-85
 Fiorino 903-1050 cc. - > 1979
 Ritmo 60. 65. 75 1978-79

03-T077002

OEM NO.

Application List

	Fiat 83-76°C	7745216
	88-83°C	
	FAE 38200	
	M22x1.5	
		
		

FIAT



Ducato
 Talento Diesel
 Punto
 Punto Convertible 60

03

03-T077003

OEM NO.

Application List

	Fiat 88-83°C	59 588 28
	92-87°C	75 762 81
		76 287 99
		76 95 951
	M22x1.5	
		





FIAT

Duna DS
 UNO
 Fiorino BUS 60

03-T077004

OEM NO.

Application List

	Fiat 97°C	41 093 78
		41 463 50
Seat		EA-95260.00
		EA-95260.01
		EA-96260.02
		EA-95260.03
		
		
		
		6.3 mm

FIAT

600
 850
 850T



SEAT

600
 600D
 800
 600L, E, Especial
 850N, D
 133

03-T100101

OEM NO.

Application List

	Lada 92-87°C	2103-03808-20000
		TM108-3803
	M22x1.5	
		

LADA



04-R120401

OEM NO.

Parameters & Materials

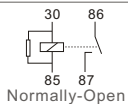
**A**
BlackHella 4RA003 510-081
Opel 1238611
Nissan 01501081-0
Panykan

Normally-Open

12V 4P 30A
Black Base
Black CoverOutline L*W*H
26.5x26.5x52

Contact Material	AgNi,AgSnO ₂	Terminal	4Pin	Remark:
Volts	12V	Rated Current	30A	
Ambient Temp.	-25C-85C	Machine Life(min.)	1x10 ⁷	
Electric(min.)	1x10 ⁵			

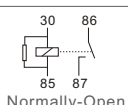
**B**
WhiteHella 4RA003 510-081
Opel 1238611
Nissan 01501081-0
Panykan

Normally-Open

12V 4P 30A
White Base
Black CoverOutline L*W*H
26.5x26.5x52

Contact Material	AgNi,AgSnO ₂	Terminal	4Pin	Remark:
Volts	12V	Rated Current	30A	
Ambient Temp.	-25C-85C	Machine Life(min.)	1x10 ⁷	
Electric(min.)	1x10 ⁵			

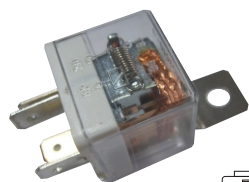
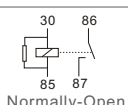
**C**
CleanHella 4RA003 510-081
Opel 1238611
Nissan 01501081-0
Panykan

Normally-Open

12V 4P 30A
White Base
Clean CoverOutline L*W*H
26.5x26.5x52

Contact Material	AgNi,AgSnO ₂	Terminal	4Pin	Remark:
Volts	12V	Rated Current	30A	
Ambient Temp.	-25C-85C	Machine Life(min.)	1x10 ⁷	
Electric(min.)	1x10 ⁵			

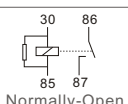
**A1**Hella 4RA003 510-081
Opel 1238611
Nissan 01501081-0
Panykan

Normally-Open

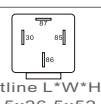
12V 4P 30A
Black Base
Black CoverOutline L*W*H
26.5x26.5x52

Contact Material	AgNi,AgSnO ₂	Terminal	4Pin	Remark:
Volts	12V	Rated Current	30A	
Ambient Temp.	-25C-85C	Machine Life(min.)	1x10 ⁷	
Electric(min.)	1x10 ⁵			

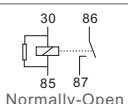
**B1**Hella 4RA003 510-081
Opel 1238611
Nissan 01501081-0
Panykan

Normally-Open

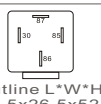
12V 4P 30A
White Base
Black CoverOutline L*W*H
26.5x26.5x52

Contact Material	AgNi,AgSnO ₂	Terminal	4Pin	Remark:
Volts	12V	Rated Current	30A	
Ambient Temp.	-25C-85C	Machine Life(min.)	1x10 ⁷	
Electric(min.)	1x10 ⁵			

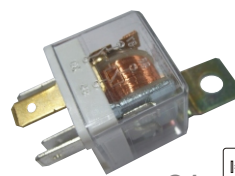
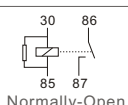
**C1**Hella 4RA003 510-081
Opel 1238611
Nissan 01501081-0
Panykan

Normally-Open

12V 4P 30A
White Base
Clean CoverOutline L*W*H
26.5x26.5x52

Contact Material	AgNi,AgSnO ₂	Terminal	4Pin	Remark:
Volts	12V	Rated Current	30A	
Ambient Temp.	-25C-85C	Machine Life(min.)	1x10 ⁷	
Electric(min.)	1x10 ⁵			



04-R240401

OEM NO.

Parameters & Materials



A
Black



Universal Hella 4RA003 510-091

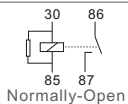

24V 4P 30A
Black Base
Black Cover



Contact Material	AgNi,AgSnO ₂	Terminal	4Pin	Remark:
Volts	24V	Rated Current	30A	
Ambient Temp.	-25C-85C	Machine Life(min.)	1x10 ⁷	
Electric(min.)	1x10 ⁵			



B
White



Universal Hella 4RA003 510-091

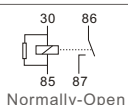

24V 4P 30A
White Base
Black Cover



Contact Material	AgNi,AgSnO ₂	Terminal	4Pin	Remark:
Volts	24V	Rated Current	30A	
Ambient Temp.	-25C-85C	Machine Life(min.)	1x10 ⁷	
Electric(min.)	1x10 ⁵			

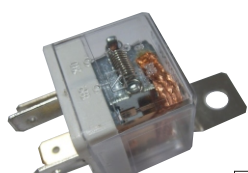

C
Clean



Universal Hella 4RA003 510-091

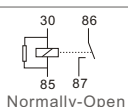

24V 4P 30A
White Base
Lean Cover



Contact Material	AgNi,AgSnO ₂	Terminal	4Pin	Remark:
Volts	24V	Rated Current	30A	
Ambient Temp.	-25C-85C	Machine Life(min.)	1x10 ⁷	
Electric(min.)	1x10 ⁵			



A1



Universal Hella 4RA003 510-091

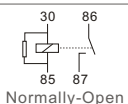

24V 4P 30A
Black Base
Black Cover



Contact Material	AgNi,AgSnO ₂	Terminal	4Pin	Remark:
Volts	24V	Rated Current	30A	
Ambient Temp.	-25C-85C	Machine Life(min.)	1x10 ⁷	
Electric(min.)	1x10 ⁵			



B1



Universal Hella 4RA003 510-091

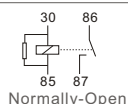

24V 4P 30A
White Base
Black Cover

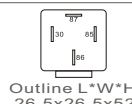

Contact Material	AgNi,AgSnO ₂	Terminal	4Pin	Remark:
Volts	24V	Rated Current	30A	
Ambient Temp.	-25C-85C	Machine Life(min.)	1x10 ⁷	
Electric(min.)	1x10 ⁵			



C1



Universal Hella 4RA003 510-091

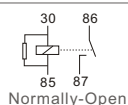

24V 4P 30A
White Base
Clean Cover

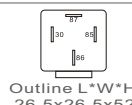

Contact Material	AgNi,AgSnO ₂	Terminal	4Pin	Remark:
Volts	24V	Rated Current	30A	
Ambient Temp.	-25C-85C	Machine Life(min.)	1x10 ⁷	
Electric(min.)	1x10 ⁵			







04

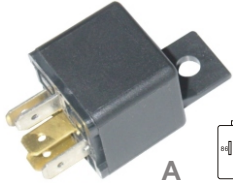

04-R120501

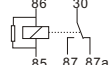
OEM NO.

Parameters & Materials

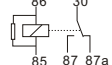
 A	Universal Hella 4RD 003 520-081 Fiat 4320625 4320629 82357825		 12V 5P 20/30A Black Base Black Cover	 Outline L*W*H 26.5x26.5x52
	 A1	Universal Hella 4RD 003 520-081 Fiat 4320625 4320629 82357825		 12V 5P 20/30A White Base Black Cover

Contact Material	AgNi,AgSnO ₂	Terminal	5Pin	Remark:
Volts	12V	Rated Current	20/30A	
Ambient Temp.	-25C-85C	Machine Life(min.)	1x10 ⁷	
Electric(min.)	1x10 ⁵			







Contact Material	AgNi,AgSnO ₂	Terminal	5Pin	Remark:
Volts	12V	Rated Current	20/30A	
Ambient Temp.	-25C-85C	Machine Life(min.)	1x10 ⁷	
Electric(min.)	1x10 ⁵			

04

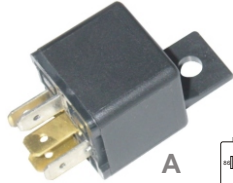
04-R240501

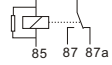
OEM NO.

Parameters & Materials

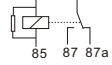
 A	Universal Hella 4RD 003 520-091		 24V 5P 20/30A Black Base Black Cover	 Outline L*W*H 26.5x26.5x52
	 A1	Universal Hella 4RD 003 520-091		 24V 5P 20/30A White Base Black Cover



Contact Material	AgNi,AgSnO ₂	Terminal	5Pin	Remark:
Volts	24V	Rated Current	20/30A	
Ambient Temp.	-25C-85C	Machine Life(min.)	1x10 ⁷	
Electric(min.)	1x10 ⁵			

Contact Material	AgNi,AgSnO ₂	Terminal	5Pin	Remark:
Volts	24V	Rated Current	20/30A	
Ambient Temp.	-25C-85C	Machine Life(min.)	1x10 ⁷	
Electric(min.)	1x10 ⁵			

04-R120502

OEM NO.

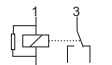
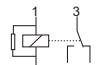
Parameters & Materials

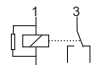
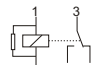

	Universal Hella 4RD 007 794-031 4RD 007 794-032		 12V 5P 40/20A White Base Black Cover	 Outline L*W*H 26.5x26.5x52
		Universal Hella 4RD 007 794-031 4RD 007 794-032		 12V 5P 40/20A White Base Black Cover

Contact Material	AgNi,AgSnO ₂	Terminal	5Pin	Remark:
Volts	12V	Rated Current	40/20A	
Ambient Temp.	-25C-85C	Machine Life(min.)	1x10 ⁷	
Electric(min.)	1x10 ⁵			

04-R240502

OEM NO.

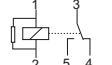
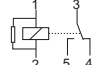
Parameters & Materials

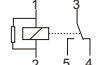
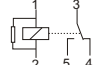
	Universal Hella 4RD 007 903-011 4RD 003 903-017		 24V 5P 20/30A White Base Black Cover	 Outline L*W*H 26.5x26.5x52
		Universal Hella 4RD 007 903-011 4RD 003 903-017		 24V 5P 20/30A White Base Black Cover



Contact Material	AgNi,AgSnO ₂	Terminal	5Pin	Remark:
Volts	24V	Rated Current	20/30A	
Ambient Temp.	-25C-85C	Machine Life(min.)	1x10 ⁷	
Electric(min.)	1x10 ⁵			



04-R120402

OEM NO.

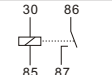
Parameters & Materials



	Bosch 0332 019453		
		12V 4P 30A Black Base Black Cover	 Outline L*W*H 29x33x55

Contact Material	AgNi,AgSnO ₂	Terminal	4Pin	Remark:
Volts	12V	Rated Current	30A	
Ambient Temp.	-25C-85C	Machine Life(min.)	1x10 ⁷	
Electric(min.)	1x10 ⁵			

04-R124501

OEM NO.

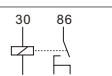
Parameters & Materials

	Bosch 0332 019150		
		12V 5P 30A Black Base Black Cover	 Outline L*W*H 29x33x55



Contact Material	AgNi,AgSnO ₂	Terminal	5Pin	Remark:
Volts	12V	Rated Current	30A	
Ambient Temp.	-25C-85C	Machine Life(min.)	1x10 ⁷	
Electric(min.)	1x10 ⁵			

04

04-R120503

OEM NO.

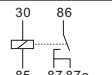
Parameters & Materials



	Bosch 0332 209150		
		12V 5P 20/30A Black Base Black Cover	 Outline L*W*H 29x33x55

Contact Material	AgNi,AgSnO ₂	Terminal	5Pin	Remark:
Volts	12V	Rated Current	20/30A	
Ambient Temp.	-25C-85C	Machine Life(min.)	1x10 ⁷	
Electric(min.)	1x10 ⁵			

04-R244501

OEM NO.

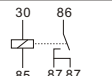
Parameters & Materials



	Bosch 0332 014203		
		24V 5P 30A Black Base Black Cover	 Outline L*W*H 29x33x55

Contact Material	AgNi,AgSnO ₂	Terminal	5Pin	Remark:
Volts	24V	Rated Current	30A	
Ambient Temp.	-25C-85C	Machine Life(min.)	1x10 ⁷	
Electric(min.)	1x10 ⁵			

04-R240503

OEM NO.

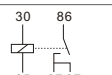
Parameters & Materials



	Bosch 0332 209203		
		24V 5P 20/30A Black Base Black Cover	 Outline L*W*H 29x33x55

Contact Material	AgNi,AgSnO ₂	Terminal	5Pin	Remark:
Volts	24V	Rated Current	20/30A	
Ambient Temp.	-25C-85C	Machine Life(min.)	1x10 ⁷	
Electric(min.)	1x10 ⁵			

04-R120504

OEM NO.

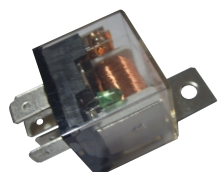
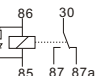
Parameters & Materials

	Universal		
		12V 5P 30/40A Black Base Clean Cover	 Outline L*W*H 27x32x53

Contact Material	AgNi,AgSnO ₂	Terminal	5Pin	Remark:
Volts	12V	Rated Current	30/40A	
Ambient Temp.	-25C-85C	Machine Life(min.)	1x10 ⁷	
Electric(min.)	1x10 ⁵			





04-R240504

OEM NO.

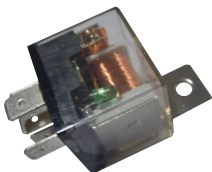
Parameters & Materials

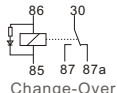

Universal

	24V 5P 30/40A	
Change-Over	Black Base	Outline L*W*H 27x32x53
	Clean Cover	

Contact Material	AgNi,AgSnO ₂	Terminal	5Pin	Remark:
Volts	24V	Rated Current	30/40A	
Ambient Temp.	-25C-85C	Machine Life(min.)	1x10 ⁷	
Electric(min.)	1x10 ⁵			

04-R120403

OEM NO.

Parameters & Materials

04



A
White Pin



B
Yellow Pin





A1



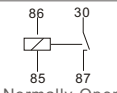

B1

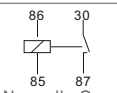

Universal	509110	
Ford	79NU 13844 2A	
	86TU 13842AA	
	86TU 14NO 89AA	
GM	52266198	
	94607594	

	12V 4P 30A	
Normally-Open	Black Base	Outline L*W*H 27x32x53
	Black Cover	

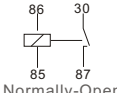

Universal	509110	
Ford	79NU 13844 2A	
	86TU 13842AA	
	86TU 14NO 89AA	
GM	52266198	
	94607594	

	12V 4P 30A	
Normally-Open	Black Base	Outline L*W*H 27x32x53
	Black Cover	

Universal	509110	
Ford	79NU 13844 2A	
	86TU 13842AA	
	86TU 14NO 89AA	
GM	52266198	
	94607594	

	12V 4P 30A	
Normally-Open	Black Base	Outline L*W*H 27x32x53
	Black Cover	

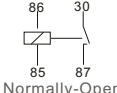
Universal	509110	
Ford	79NU 13844 2A	
	86TU 13842AA	
	86TU 14NO 89AA	
GM	52266198	
	94607594	

	12V 4P 30A	
Normally-Open	Black Base	Outline L*W*H 27x32x53
	Black Cover	

Contact Material	AgNi,AgSnO ₂	Terminal	4Pin	Remark:
Volts	12V	Rated Current	30A	
Ambient Temp.	-25C-85C	Machine Life(min.)	1x10 ⁷	
Electric(min.)	1x10 ⁵			

Contact Material	AgNi,AgSnO ₂	Terminal	4Pin	Remark:
Volts	12V	Rated Current	30A	
Ambient Temp.	-25C-85C	Machine Life(min.)	1x10 ⁷	
Electric(min.)	1x10 ⁵			

Contact Material	AgNi,AgSnO ₂	Terminal	4Pin	Remark:
Volts	12V	Rated Current	30A	
Ambient Temp.	-25C-85C	Machine Life(min.)	1x10 ⁷	
Electric(min.)	1x10 ⁵			

Contact Material	AgNi,AgSnO ₂	Terminal	4Pin	Remark:
Volts	12V	Rated Current	30A	
Ambient Temp.	-25C-85C	Machine Life(min.)	1x10 ⁷	
Electric(min.)	1x10 ⁵			



04-R120505

OEM NO.

Parameters & Materials

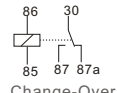

Chrysler	4671056	
GM	12088504	12065116
	12077876	12088594
	12088596	12167112
	22555387	22570060
	30013238	

	12V 5P 30/40A	
Change-Over	Black Base	Outline L*W*H
	Black Cover	













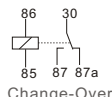

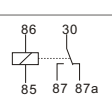

Contact Material	AgNi,AgSnO ₂	Terminal	5Pin	Remark:
Volts	12V	Rated Current	30/40A	
Ambient Temp.	-25C-85C	Machine Life(min.)	1x10 ⁷	
Electric(min.)	1x10 ⁵			

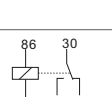

04-R120506

OEM NO.

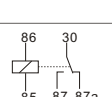
Parameters & Materials

 A White Pin	Universal			
	 Change-Over	12V 5P 30/40A Black Base Black Cover	 Outline L*W*H 27x32x53	
 B Yellow Pin	Universal			
	 Change-Over	12V 5P 30/40A Black Base Black Cover	 Outline L*W*H 27x32x53	
 A1	Universal			
	 Change-Over	12V 5P 30/40A Black Base Black Cover	 Outline L*W*H 27x32x53	
 B1	Universal			
	 Change-Over	12V 5P 30/40A Black Base Black Cover	 Outline L*W*H 27x32x53	

Contact Material	AgNi,AgSnO ₂	Terminal	5Pin	Remark:
Volts	12V	Rated Current	30/40A	
Ambient Temp.	-25C-85C	Machine Life(min.)	1x10 ⁷	
Electric(min.)	1x10 ⁵			

Contact Material	AgNi,AgSnO ₂	Terminal	5Pin	Remark:
Volts	12V	Rated Current	30/40A	
Ambient Temp.	-25C-85C	Machine Life(min.)	1x10 ⁷	
Electric(min.)	1x10 ⁵			

Contact Material	AgNi,AgSnO ₂	Terminal	5Pin	Remark:
Volts	12V	Rated Current	30/40A	
Ambient Temp.	-25C-85C	Machine Life(min.)	1x10 ⁷	
Electric(min.)	1x10 ⁵			







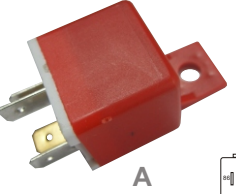

Contact Material	AgNi,AgSnO ₂	Terminal	5Pin	Remark:
Volts	12V	Rated Current	30/40A	
Ambient Temp.	-25C-85C	Machine Life(min.)	1x10 ⁷	
Electric(min.)	1x10 ⁵			

04

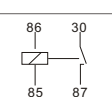
04-R120404

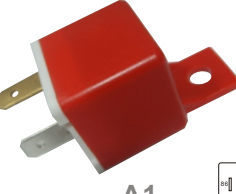
OEM NO.

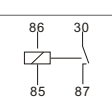
Parameters & Materials

 A Red	Universal			
	 Normally-Open	12V 4P 30A White Base Red Cover	 Outline L*W*H 26.5x26.5x52	
 A1	Universal			
	 Normally-Open	12V 4P 30A White Base Red Cover	 Outline L*W*H 26.5x26.5x52	

Contact Material	AgNi,AgSnO ₂	Terminal	4Pin	Remark:
Volts	12V	Rated Current	30A	
Ambient Temp.	-25C-85C	Machine Life(min.)	1x10 ⁷	
Electric(min.)	1x10 ⁵			

Contact Material	AgNi,AgSnO ₂	Terminal	4Pin	Remark:
Volts	12V	Rated Current	30A	
Ambient Temp.	-25C-85C	Machine Life(min.)	1x10 ⁷	
Electric(min.)	1x10 ⁵			



04-R120402

OEM NO.

Parameters & Materials



B
Black



Universal

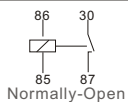

12V 4P 30A
Black Base
Black Cover

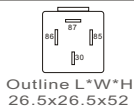

Outline L*W*H
26.5x26.5x52

Contact Material	AgNi,AgSnO ₂	Terminal	4Pin	Remark:
Volts	12V	Rated Current	30A	
Ambient Temp.	-25C-85 C	Machine Life(min.)	1x10 ⁷	
Electric(min.)	1x10 ⁵			



C
White Base



Universal

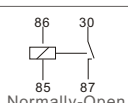

12V 4P 30A
White Base
Black Cover

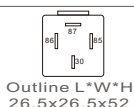

Outline L*W*H
26.5x26.5x52

Contact Material	AgNi,AgSnO ₂	Terminal	4Pin	Remark:
Volts	12V	Rated Current	30A	
Ambient Temp.	-25C-85 C	Machine Life(min.)	1x10 ⁷	
Electric(min.)	1x10 ⁵			

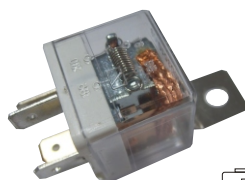

D
Clean



Universal

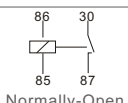

12V 4P 30A
White Base
Clean Cover

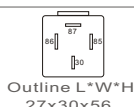

Outline L*W*H
27x30x56

Contact Material	AgNi,AgSnO ₂	Terminal	4Pin	Remark:
Volts	12V	Rated Current	30A	
Ambient Temp.	-25C-85 C	Machine Life(min.)	1x10 ⁷	
Electric(min.)	1x10 ⁵			



B1



Universal

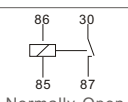

12V 4P 30A
Black Base
Black Cover

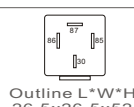

Outline L*W*H
26.5x26.5x52

Contact Material	AgNi,AgSnO ₂	Terminal	4Pin	Remark:
Volts	12V	Rated Current	30A	
Ambient Temp.	-25C-85 C	Machine Life(min.)	1x10 ⁷	
Electric(min.)	1x10 ⁵			



C1



Universal

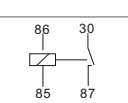

12V 4P 30A
White Base
Black Cover



Outline L*W*H
26.5x26.5x52

Contact Material	AgNi,AgSnO ₂	Terminal	4Pin	Remark:
Volts	12V	Rated Current	30A	
Ambient Temp.	-25C-85 C	Machine Life(min.)	1x10 ⁷	
Electric(min.)	1x10 ⁵			



D1



Universal

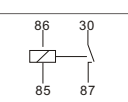

12V 4P 30A
White Base
Clean Cover

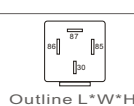

Outline L*W*H
27x30x56

Contact Material	AgNi,AgSnO ₂	Terminal	4Pin	Remark:
Volts	12V	Rated Current	30A	
Ambient Temp.	-25C-85 C	Machine Life(min.)	1x10 ⁷	
Electric(min.)	1x10 ⁵			



04-R066001 **OEM NO.** **Parameters & Materials**

	Kia	KKY01-61-580	
			 Outline L*W*H

Contact Materials	AgNi,AgSnO ₂	Terminal	12 Pin	Remark:
Volts	12V	Rated Current	25A	
Ambient Temp.	-25°C-85°C	Machine Life(min.)	1x10 ⁶	
Electricity(min.)	1x10 ⁶			

04-R066002 **OEM NO.** **Parameters & Materials**

	Kia	K191-67-830C	
			 Outline L*W*H

Contact Materials	AgNi,AgSnO ₂	Terminal	7 Pin	Remark:
Volts	12V	Rated Current	30A	
Ambient Temp.	-25°C-85°C	Machine Life(min.)	1x10 ⁶	
Electricity(min.)	1x10 ⁶			

04

04-R066003 **OEM NO.** **Parameters & Materials**

	Kia MAZDA	KKY02-67-67-740 KKY02-67-67-740	
			 Outline L*W*H

Contact Materials	AgNi,AgSnO ₂	Terminal	4 Pin	Remark:
Volts	12V	Rated Current	30A	
Ambient Temp.	-25°C-85°C	Machine Life(min.)	1x10 ⁶	
Electricity(min.)	1x10 ⁶			

04-R066004 **OEM NO.** **Parameters & Materials**

	Kia	KKY01-67-740	
			 Outline L*W*H

Contact Materials	AgNi,AgSnO ₂	Terminal	4 Pin	Remark:
Volts	12V	Rated Current	30A	
Ambient Temp.	-25°C-85°C	Machine Life(min.)	1x10 ⁶	
Electricity(min.)	1x10 ⁶			

04-R066005 **OEM NO.** **Parameters & Materials**

 A With KKY01-67-740	Kia	KKY01-67-740	
			 Outline L*W*H
 B With KKY02-67-67-740	Kia	KKY02-67-67-740	
			 Outline L*W*H

Contact Materials	AgNi,AgSnO ₂	Terminal	4 Pin	Remark:
Volts	12V	Rated Current	30A	
Ambient Temp.	-25°C-85°C	Machine Life(min.)	1x10 ⁶	
Electricity(min.)	1x10 ⁶			



04-R066006

OEM NO.

Parameters & Materials

	Kia	KKY01-61-581			Outline L*W*H

Contact Materials	AgNi,AgSnO ₂	Terminal	12 Pin	Remark:
Volts	12V	Rated Current	25A	
Ambient Temp.	-25°C-85°C	Machine Life(min.)	1x10	
Electrice(min.)	1x10			

04-R066007

OEM NO.

Parameters & Materials

	Kia	KKY01-61-0540			Outline L*W*H

Contact Materials	AgNi,AgSnO ₂	Terminal	5 Pin	Remark:
Volts	12V	Rated Current	30A	
Ambient Temp.	-25°C-85°C	Machine Life(min.)	1x10	
Electrice(min.)	1x10			

04-R066008

OEM NO.

Parameters & Materials

	Kia	077200-0482			Outline L*W*H
	Toyota	85940-95D00			

Contact Materials	AgNi,AgSnO ₂	Terminal	5 Pin	Remark:
Volts	12V	Rated Current	30A	
Ambient Temp.	-25°C-85°C	Machine Life(min.)	1x10	
Electrice(min.)	1x10			

04-R022101

OEM NO.

Parameters & Materials

	Citroen	Dc00319980	96271095	
			96271096	
	Peugeot	96075406	96196965	
		1929.49	1920.3X	
		1920.3N		

Contact Materials	AgNi,AgSnO ₂	Terminal	15 Pin	Remark:
Volts	12V	Rated Current	20/30A	
Ambient Temp.	-25°C-85°C	Machine Life(min.)	1x10	
Electrice(min.)	1x10			

04-R022102

OEM NO.

Parameters & Materials

	Peugeot	03 538		
	Renault	7700755267		
		7700810930		
		7702082573		
		7700804117		
		7700810931		

Contact Materials	AgNi,AgSnO ₂	Terminal	5 Pin	Remark:
Volts	12V	Rated Current	25A	
Ambient Temp.	-25°C-85°C	Machine Life(min.)	1x10	
Electrice(min.)	1x10			

04-R022103

OEM NO.

Parameters & Materials

	Peugeot	21 31		
	Renault	7700810932		
		7700810933		
	Citroen	9606364880		

Contact Materials	AgNi,AgSnO ₂	Terminal	4 Pin	Remark:
Volts	12V	Rated Current	25A	
Ambient Temp.	-25°C-85°C	Machine Life(min.)	1x10	
Electrice(min.)	1x10			



04-R099001 **OEM NO.** **Parameters & Materials**



Peugeot 10758
Paykan 10758

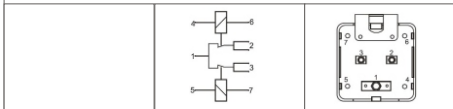

Contact Materials	AgNi, AgSnO ₂	Terminal	8 Pin	Remark:
Volts	12V	Rated Current	25A	
Ambient Temp.	-25°C-85°C	Machine Life(min.)	1x10 ⁶	
Electricity(min.)	1x10 ⁶			

04

04-R099002 **OEM NO.** **Parameters & Materials**

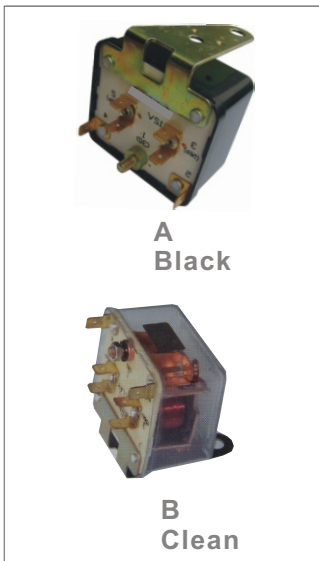

Peugeot 10758A
Paykan 10758A

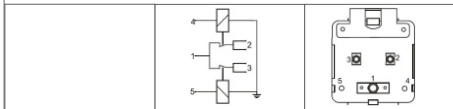

Contact Materials	AgNi, AgSnO ₂	Terminal	6 Pin	Remark:
Volts	12V	Rated Current	25A	
Ambient Temp.	-25°C-85°C	Machine Life(min.)	1x10 ⁶	
Electricity(min.)	1x10 ⁶			

04-R099003 **OEM NO.** **Parameters & Materials**



Paykan 75824V

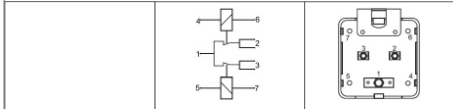

Contact Materials	AgNi, AgSnO ₂	Terminal	6 Pin	Remark:
Volts	12V	Rated Current	25A	
Ambient Temp.	-25°C-85°C	Machine Life(min.)	1x10 ⁶	
Electricity(min.)	1x10 ⁶			



05-S011001		OEM NO.	Application List
	Benz 000 8209010		BENZ 190 200-300 260 SE-560SEL 280 SL-500SL S-CLASS 260 SE,280,300 380,420,500,560
	 8Pin		

05-S011002		OEM NO.	Application List
	Benz 124 8200110		BENZ
	 8Pin		

05

05-S011003		OEM NO.	Application List
	Benz 1148545 510 124 820 4510KZ		BENZ(W124)
	 5Pin		

05-S011004		OEM NO.	Application List
	Benz 1148454 610 124 820 4610KZ		BENZ(W124)
	 5Pin		

05-S011005		OEM NO.	Application List
	Benz 124 82047 10KZ		BENZ(W124)
	 6Pin		

05-S011006		OEM NO.	Application List
	Benz 124 82048 10KZ		BENZ(W124)
	 6Pin		

**05-S022101****OEM NO.****Application List**

	Peugeot 6552.V0 6552.V1			PEUGEOT
			6Pin	

05-S022102**OEM NO.****Application List**

	Peugeot 96086187			PEUGEOT 405
			5Pin	

05-S022103**OEM NO.****Application List**

	Peugeot			PEUGEOT SAMAND
			6Pin	

05**05-S022104****OEM NO.****Application List**

	Peugeot			PEUGEOT SAMAND
			5Pin	

05-S022105**OEM NO.****Application List**

	Peugeot 6552.A1			PEUGEOT 405
			4Pin	

05-S022106**OEM NO.****Application List**

	Peugeot 6552.A3 96000584			PEUGEOT 405
			5Pin	



05-S022107

OEM NO.

Application List

	Peugeot	PEUGEOT	
			5Pin

05-S022108

OEM NO.

Application List

	Peugeot	PEUGEOT	
			9Pin

05-S022109

OEM NO.

Application List

05

	Peugeot 9420239908	PEUGEOT	
			405 8Pin

05-S022110

OEM NO.

Application List

	Peugeot 6552.A0 96000588	PEUGEOT	
			405 9Pin

05-S066001

OEM NO.

Application List

	Kia KK12B-66-370	KIA	
			KIA Pride 5Pin

05-S066002

OEM NO.







Application List

	Kia KK12B-66-350	KIA	
			KIA Pride 6Pin

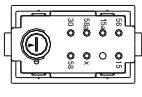
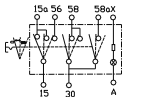

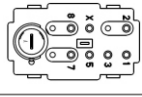

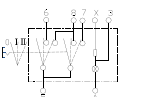
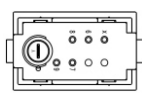

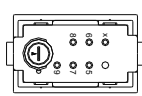
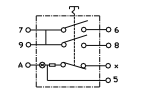



05-S066003		OEM NO.	Application List	
	Kia KK151-66-500B		KIA KIA Pride	
			4Pin	
05-S066004		OEM NO.	Application List	
	Kia KK136-66-460		KIA KIA Pride	
			4Pin	
05-S066005		OEM NO.	Application List	
	Kia KKY01-61-200		KIA KIA Pride	
			5Pin	
05-S099001		OEM NO.	Application List	
	Paykan		PAYKAN PAYKAN	
			3Pin	
05-S000001		OEM NO.	Application List	
	Volvo 1578706		VOLVO	
			4Pin	
05-S000002		OEM NO.	Application List	
	Volvo 1578700		VOLVO	
			9Pin	







05-S000003		OEM NO.	Application List	
	Volvo 1578702			8Pin
		VOLVO		
05-S000004		OEM NO.	Application List	
	Volvo 1578756			8Pin
		VOLVO		
05-S000005		OEM NO.	Application List	
05 	Volvo 1578760 8152142			8Pin
		VOLVO		
05-S000006		OEM NO.	Application List	
	Volvo 1578704			7Pin
		VOLVO		
05-S000007		OEM NO.	Application List	
	Volvo			6Pin
		VOLVO		
05-S000008		OEM NO.	Application List	
	Volvo 1578732			7Pin
		VOLVO		











06-Y011001		OEM NO.		Application List	
	Benz 005 542 18 17 006 542 94 17 VDO 29/66		BENZ		
	 M12x1.5		Pressure 0-3	 4mm	





06-Y011002		OEM NO.		Application List	
	Benz 009 542 08 17		BENZ		
	 M12x1.5		Pressure 0-3	 4mm	

06-Y011003		OEM NO.		Application List	
	Benz 001 542 82 17 004 542 43 17 VDO 002 874 61 11		BENZ		
	 M18x1.5		Pressure 0-5	 6.35 mm	

06

06-Y011004		OEM NO.		Application List		
	Benz 002 542 17 17 VDO 360.081 360.034 360.004 360.032 360.001 Porsche 928 606 203 01 928 606 203 02		BENZ			VDO
	 M18x1.5		Pressure 0-5 0.25	 M4	PORSCHE	



06-Y011005		OEM NO.		Application List	
	Benz 004 542 89 17 001 542 49 17 684 542 73 17 VDO 29/65		BENZ		
	 M14x1.5		Pressure 0-5	 M4	

06-Y011006		OEM NO.		Application List	
	Benz 001 542 56 17 001 542 90 17		BENZ		
	 M14x1.5		Pressure 0-5&0-10	 M4	



**06-Y011007****OEM NO.****Application List**

	Benz 002 542 1717 Prosche 92860620301 92860620302 VDO 34/4			BENZ	PROSCHE	VDO
	M18x1.5		Pressure 0-5 0.25			



06-Y011008**OEM NO.****Application List**

	Benz 006 542 32 17 VDO 29/85			BENZ		VDO
	M12x1.5		Pressure 0-5			



06-Y000001**OEM NO.****Application List**

	Volvo & Man 81274210109 360 081 064 001C			VOLVO		
	M18x1.5		Pressure 0-5 0.25			



06**06-Y000002****OEM NO.****Application List**

	Volvo 3344174-2			VOLVO		
	M14x1.5		Pressure 0-5 0.25			

06-Y022001**OEM NO.****Application List**

	Renault 7700 690 868 7700 709 565 7700 754 383 Jaeger 32688901 33303601 08361205			RENAULT	PAYKAN	
	M10x1.0		Pressure 0.6 0.7			

06-Y022002**OEM NO.****Application List**

	Renault 360 081 360 032 360 001			RENAULT		
	1/8x28 BSP		Pressure 0.8 0-10			

OTHER NEW DEVELOPENT SENSORS

07-L066001

OEM NO.

Application List

	KIA OK71E17400A		
	12V 3Pin		

KIA

07-L099001

OEM NO.

Application List

	PAYKAN		
	12V 3Pin		

PAYKAN

08-J099001

OEM NO.

Application List

	PAYKAN 09359409		
	5V 3Pin 100KPA		

PAYKAN

08-J022101

OEM NO.

Application List

	Peugeot 1920 J7 Citroen 1563 J4 1563 J7 96092693 Hella 6PP 009 400-061		
	5V 3Pin 105KPA		

PEUGEOT CITROEN