

# CYLINDER HEAD ASSY

MAZDA

ISO9001:2000/TS16949

AMC NO.	OEM NO.	ENGINE	VALVE/CM <sup>3</sup>	APPLICATION
908 506	11039-VC10A 11039-VC101	ZD30	16 3.0	PATROL GR DTI TERRANO II DTI URBAN D DTI

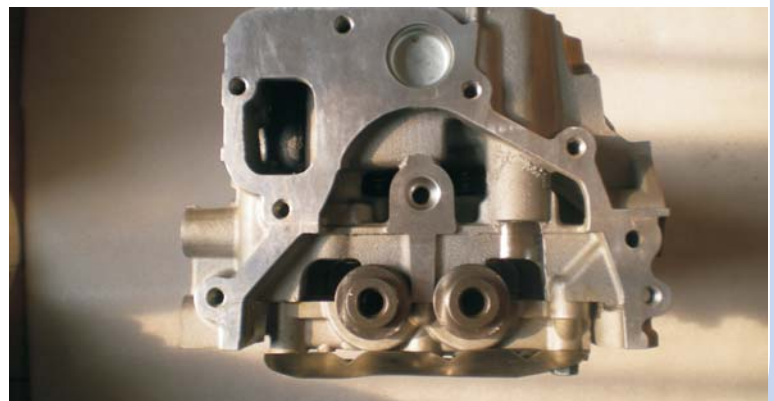
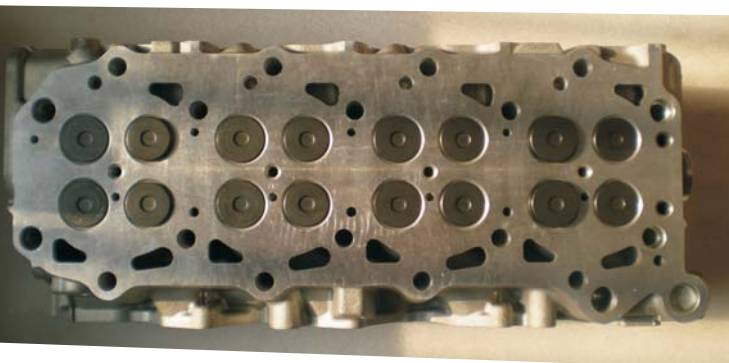
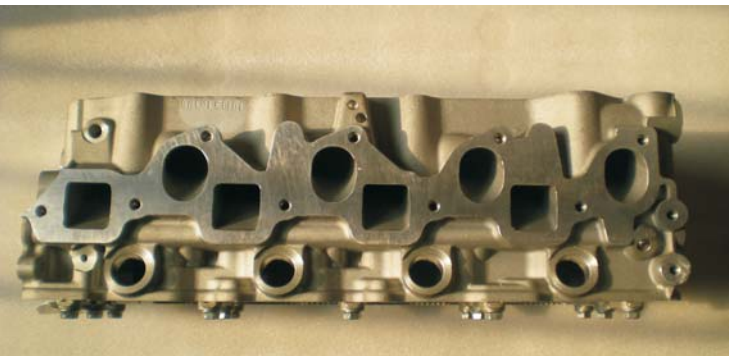
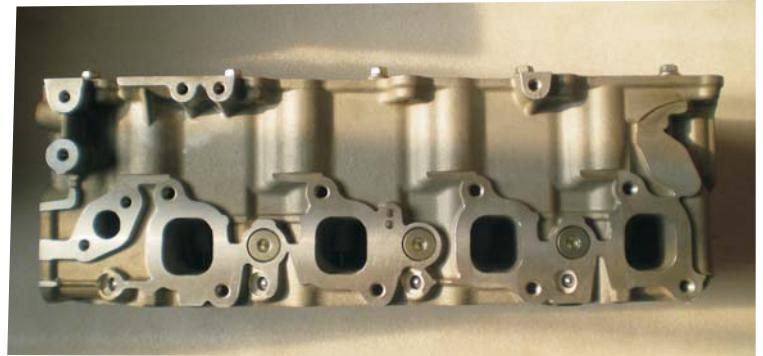
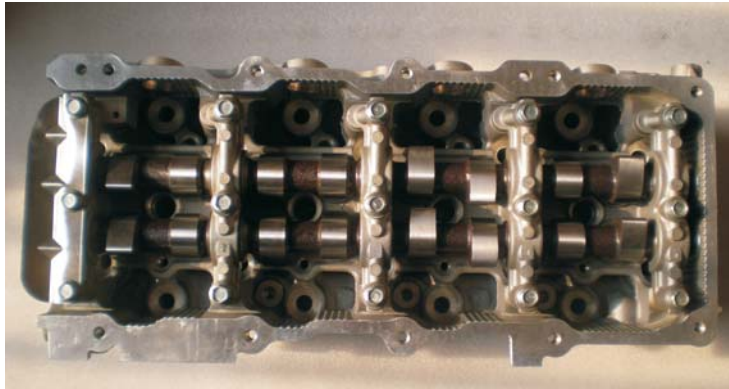

# CYLINDER HEAD ASSY

MITSUBISHI

ISO9001:2000/TS16949

AMC NO.	OEM NO.	ENGINE	VALVE/CM <sup>3</sup>	APPLICATION
908 512	MD185920 MD185926 MD109736	4D56	8 2.5TD	MONTERO PAJERO L300 CANTER

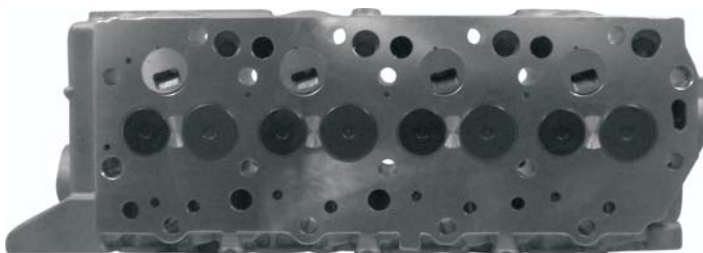
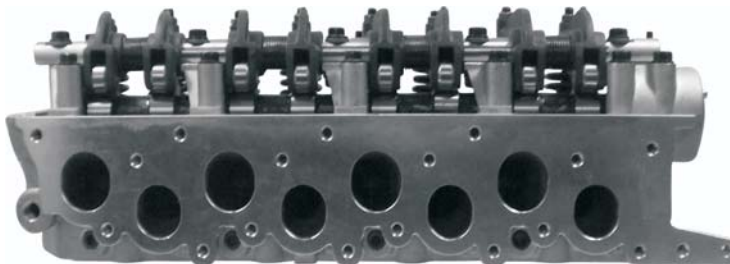
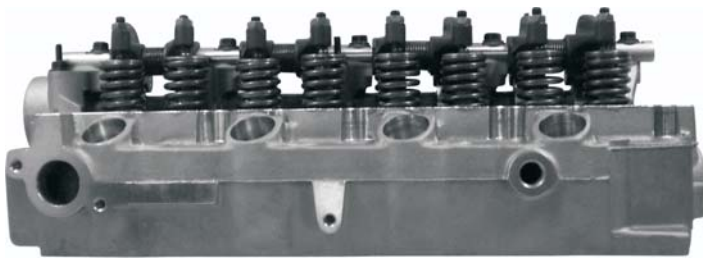

AMC NO.	OEM NO.	ENGINE	VALVE/CM <sup>3</sup>	APPLICATION
908 511	MD185922 MD109733 MD185918 MD305542	4D56 4D55	8 2.5D 2.3D	MONTERO PAJERO L300 CANTER

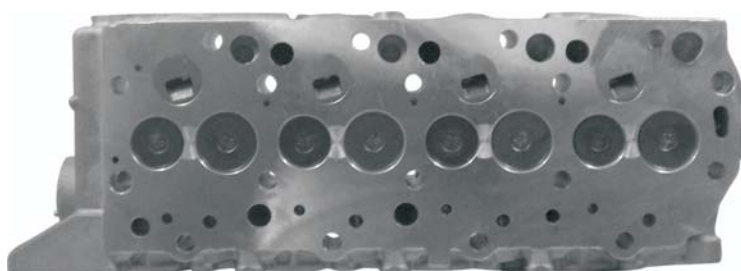
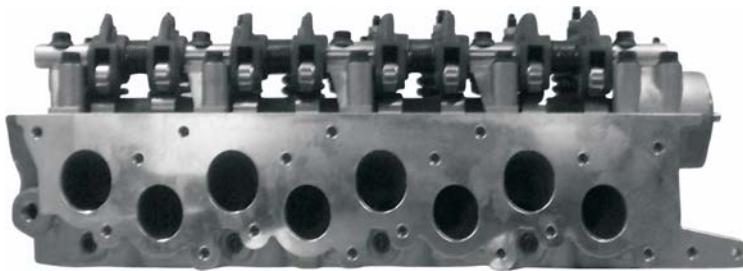

AMC NO.	OEM NO.	ENGINE	VALVE/CM <sup>3</sup>	APPLICATION
908 513	MD303750 MD348983 MD351277	4D56	8 2.5TD	MONTERO PAJERO L300 CANTER

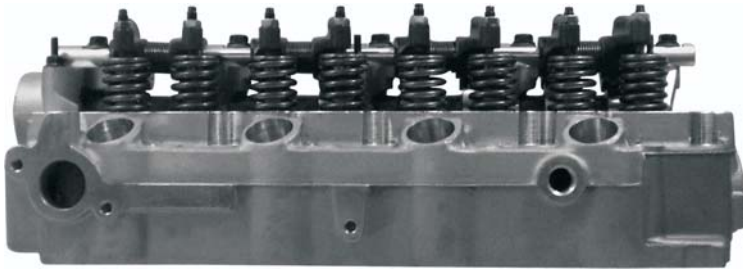

# CYLINDER HEAD ASSY

**MITSUBISHI**

**ISO9001:2000/TS16949**

AMC NO.	OEM NO.	ENGINE	VALVE/CM <sup>3</sup>	APPLICATION
908 770	22100-42700	4D56 4D55	8 2.5D	MITSUBISHI HYUNDAI H100 HYUNDAI H1

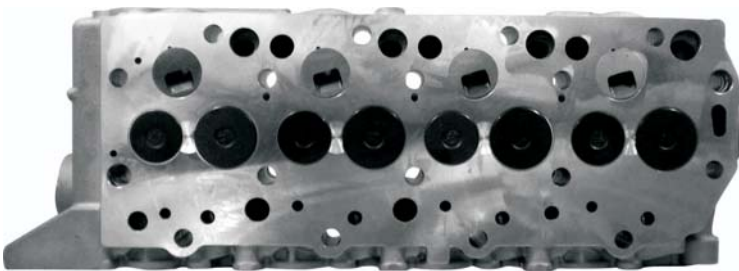
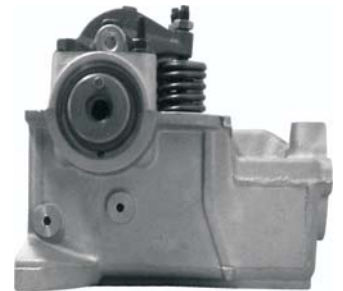
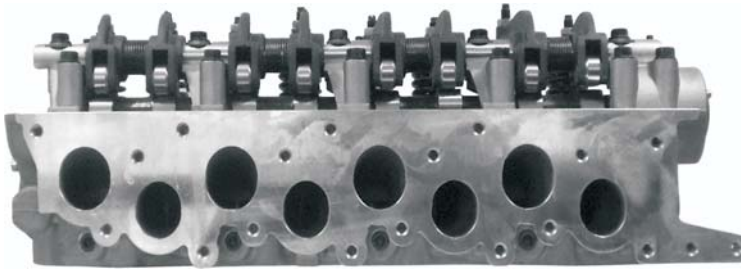

# CYLINDER HEAD ASSY

MITSUBISHI

ISO9001:2000/TS16949

AMC NO.	OEM NO.	ENGINE	VALVE/CM <sup>3</sup>	APPLICATION
908 514	ME202620	4M40T	8 2.8TD	MONTERO PAJERO GLX/GLS

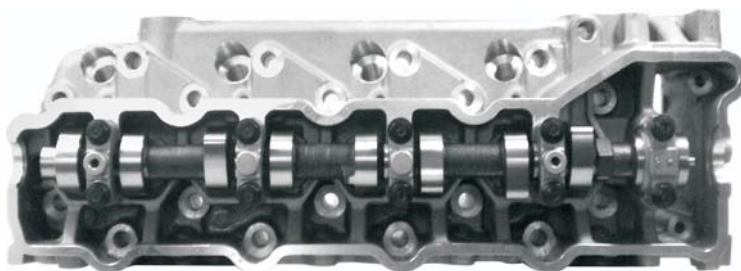
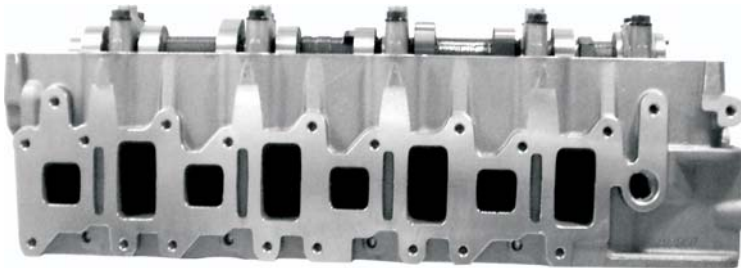

# CYLINDER HEAD ASSY

**mitsubishi**

**ISO9001:2000/TS16949**

AMC NO.	OEM NO.	ENGINE	VALVE/CM <sup>3</sup>	APPLICATION
910 075	MD311828 MD086520 MD026520 MD151982	4G54 G54B	8 2.6	PAJERO/L047/V32 MORTERO/PICK-UP STARBO/TURBO CARAVAN

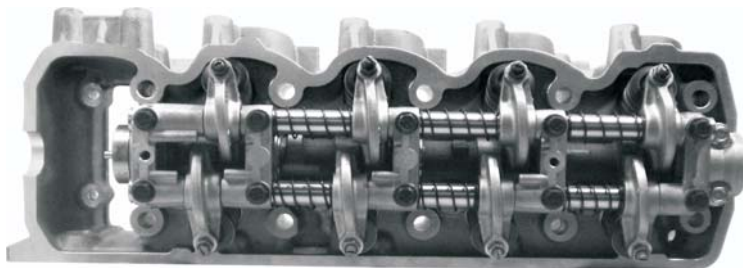

# CYLINDER HEAD ASSY

MAZDA

ISO9001:2000/TS16949

AMC NO.	OEM NO.	ENGINE	VALVE/CM <sup>3</sup>	APPLICATION
	FE70 10100F F850 10100F FE11-10-100E FE2K-10-100A FE4J-10-100A/C	FE/F8	8 1.8 2.0	MAZDA 626/929/E1800

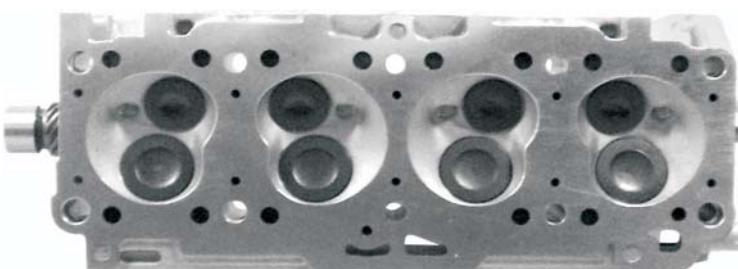
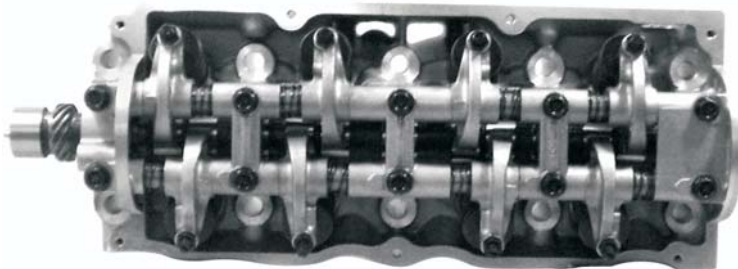



# CYLINDER HEAD ASSY

MAZDA

ISO9001:2000/TS16949

AMC NO.	OEM NO.	ENGINE	VALVE/CM <sup>3</sup>	APPLICATION
908 741	R2L1-10-100D /E/A/B	RF	8 2.2D 2.0D	323/626/E2200 B 2200/PREMACY CAPELLA/BONGO COSMO 2000



# CYLINDER HEAD ASSY

TOYOTA

ISO9001:2000/TS16949

AMC NO.	OEM NO.	ENGINE	VALVE/CM <sup>3</sup>	APPLICATION
910 070	11101-35080 11101-35060	22R 22RE 22R-TE	8 2.4	4RUNNER4WR CELICA/PICK-UP CRESSIDA/SUPRA

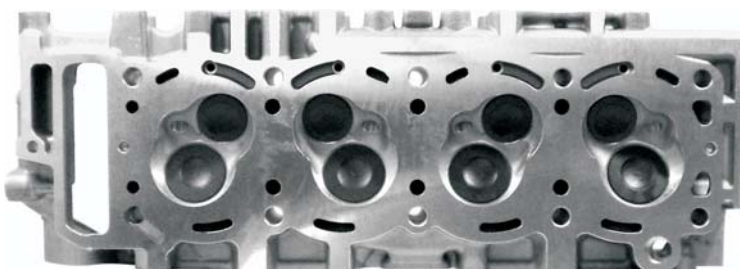
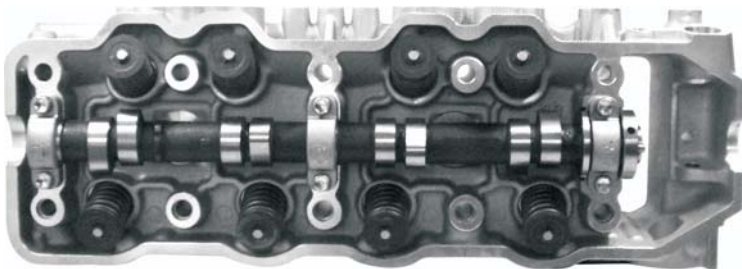

# CYLINDER HEAD ASSY

TOYOTA

ISO9001:2000/TS16949

AMC NO.	OEM NO.	ENGINE	VALVE/CM <sup>3</sup>	APPLICATION
908 780	11101-69128	1KZ-T	8 3.0TD	4RUNNER TD LAND CRUISER TD

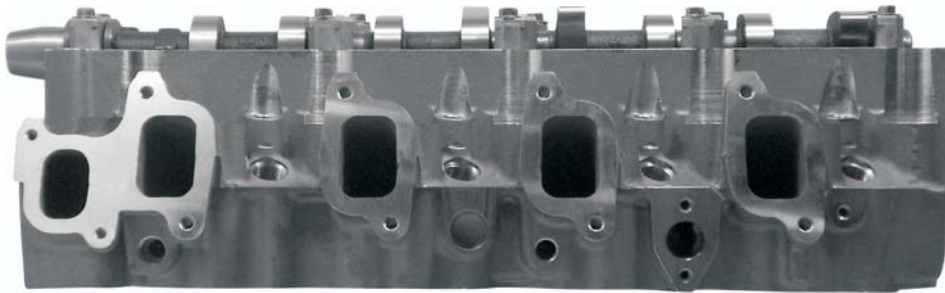

# CYLINDER HEAD ASSY

TOYOTA

ISO9001:2000/TS16949

AMC NO.	OEM NO.	ENGINE	VALVE/CM <sup>3</sup>	APPLICATION
908 782	11101-69175	1KZ-TE	8 3.0TD	4RUNNER TD LAND CRUISER TD



# CYLINDER HEAD ASSY

TOYOTA

ISO9001:2000/TS16949

AMC NO.	OEM NO.	ENGINE	VALVE/CM <sup>3</sup>	APPLICATION
	11101-73020	4Y	8 2.4	491Q

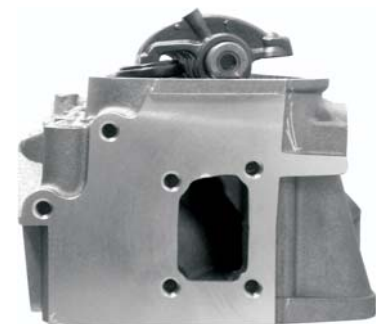
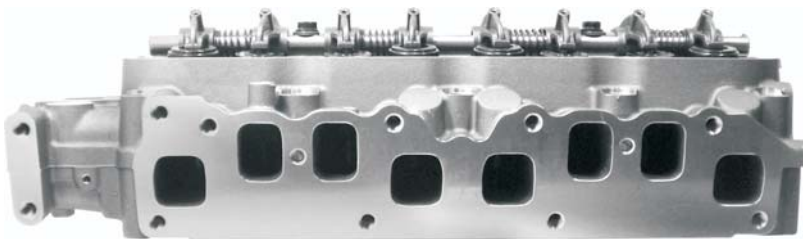

# CYLINDER HEAD ASSY

TOYOTA

ISO9001:2000/TS16949

AMC NO.	OEM NO.	ENGINE	VALVE/CM <sup>3</sup>	APPLICATION
	11101-65021	3VZ-L	6 3.0	CAMER/T100 4RUNNER

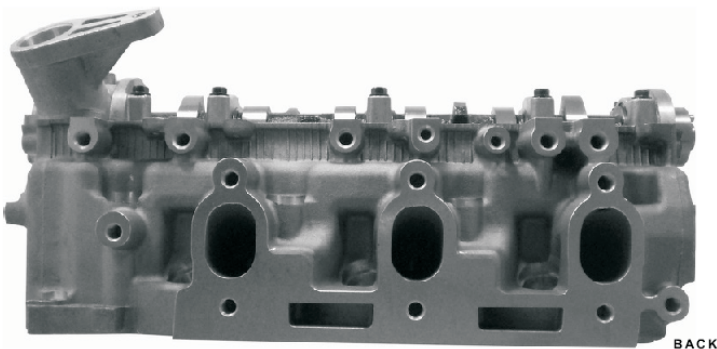
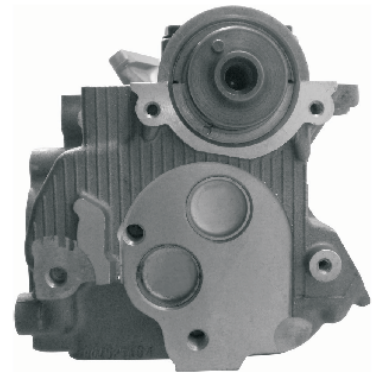
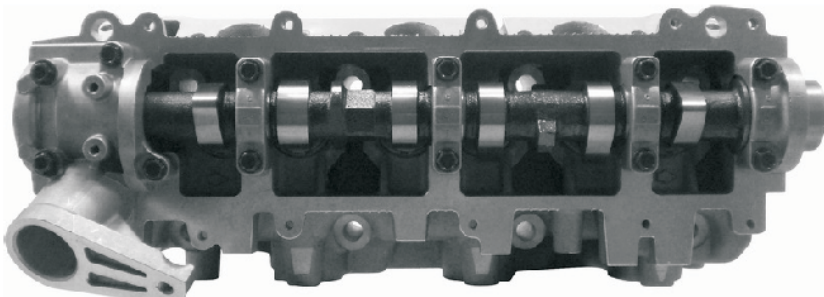
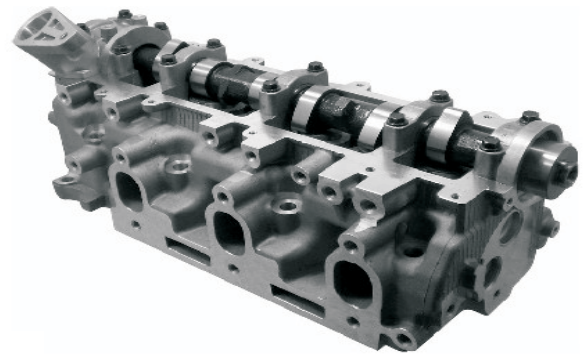
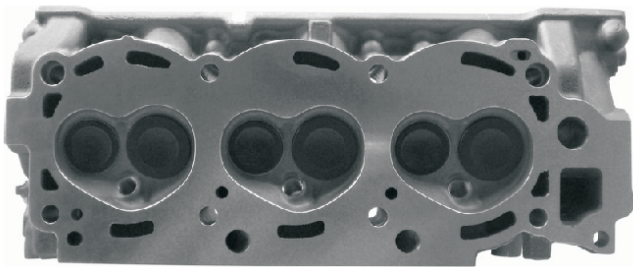

BACK

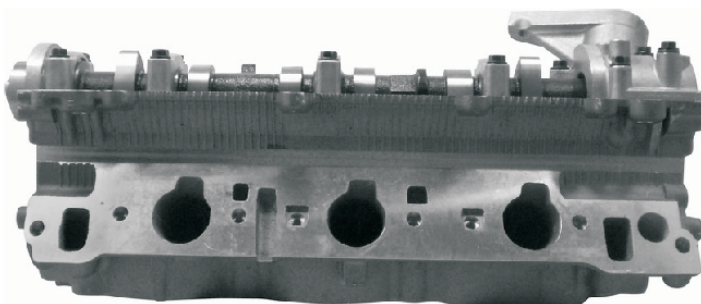
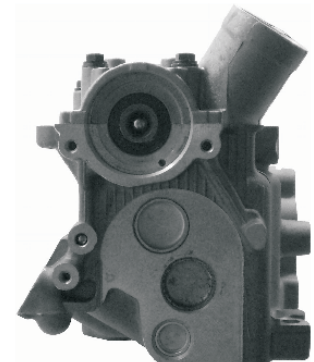

# CYLINDER HEAD ASSY

TOYOTA

ISO9001:2000/TS16949

AMC NO.	OEM NO.	ENGINE	VALVE/CM <sup>3</sup>	APPLICATION
	11101-65011	3VZ-R	6 3.0	CAMER/T100 4RUNNER

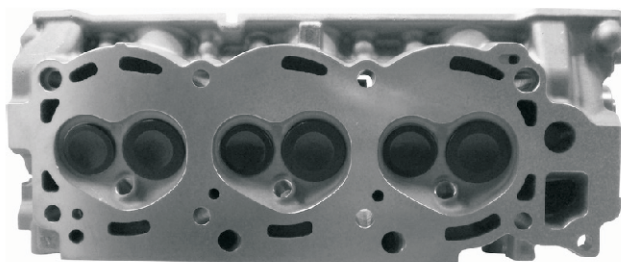
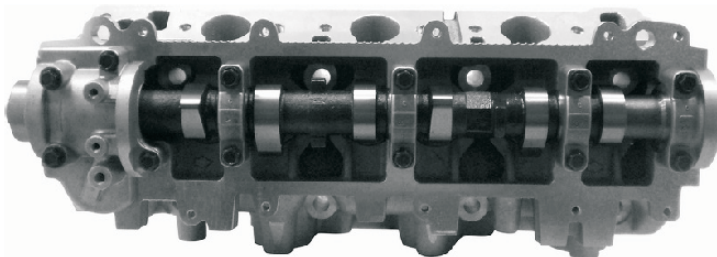
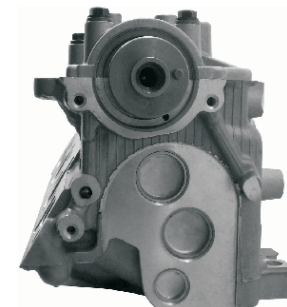
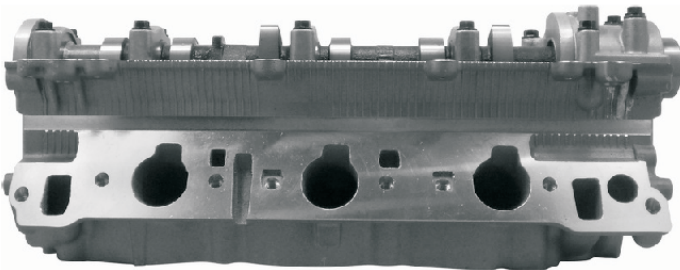
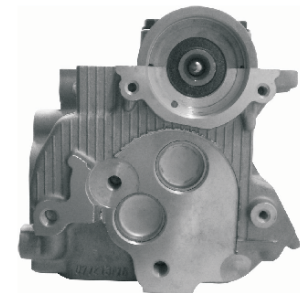

# CYLINDER HEAD ASSY

TOYOTA

ISO9001:2000/TS16949

AMC NO.	OEM NO.	ENGINE	VALVE/CM <sup>3</sup>	APPLICATION
	11101-75012	1RZ	8 2.0	HIACE

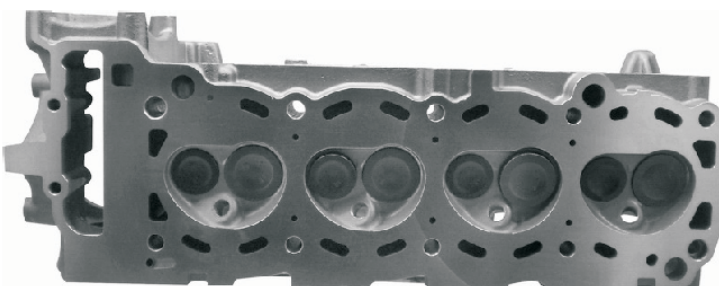
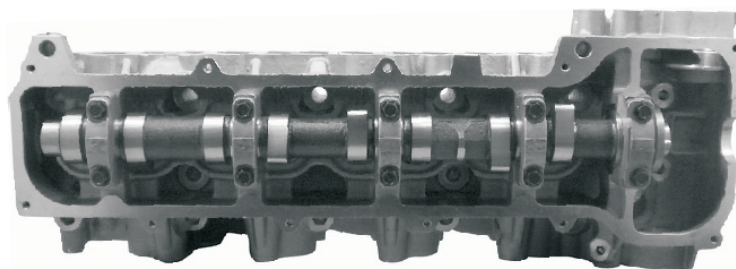
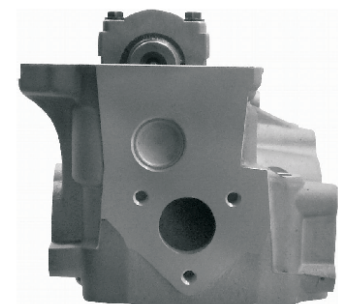
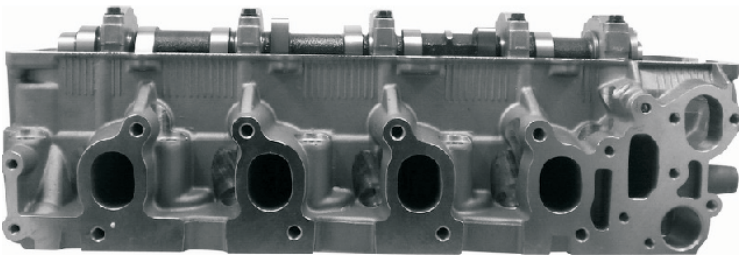
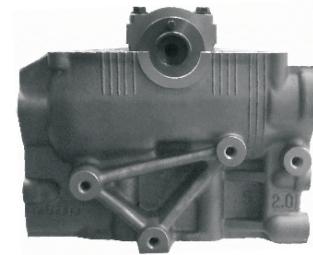
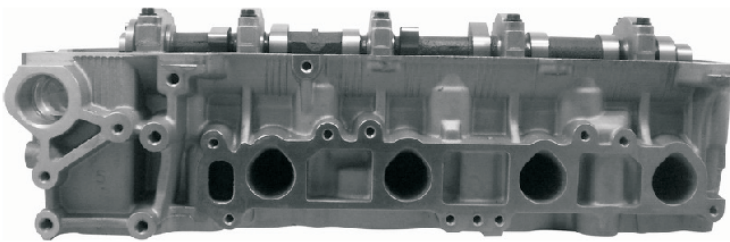



# CYLINDER HEAD ASSY

TOYOTA

ISO9001:2000/TS16949

AMC NO.	OEM NO.	ENGINE	VALVE/CM <sup>3</sup>	APPLICATION
909 055	11101-54050	2L	8 2.0	Hi-Lux 2400 / 4-Runner HiAce Land Cruiser

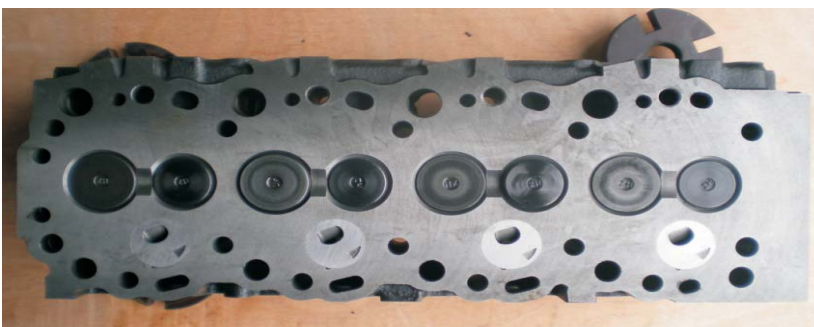
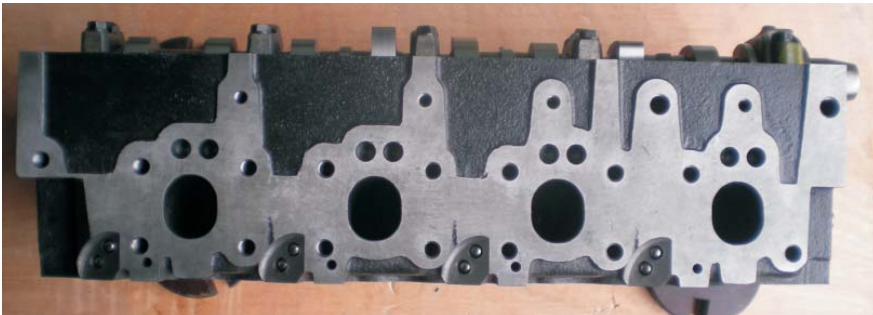
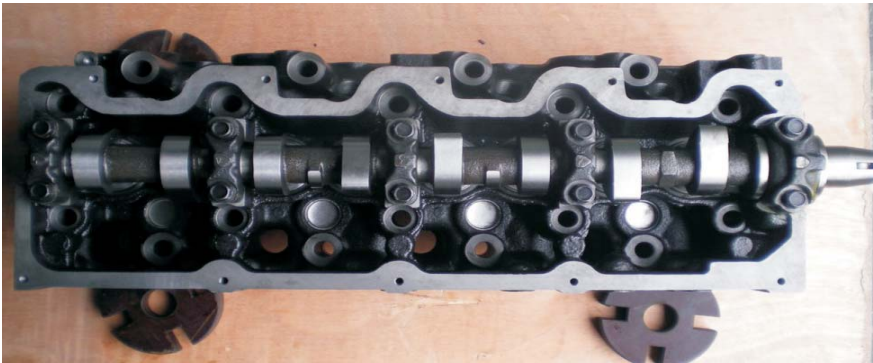

# CYLINDER HEAD ASSY

TOYOTA

ISO9001:2000/TS16949

AMC NO.	OEM NO.	ENGINE	VALVE/CM <sup>3</sup>	APPLICATION
909 053	11101-54131	3L	8 2.0	Hi-Lux /4-Runner HiAce /Land Cruiser Dyna

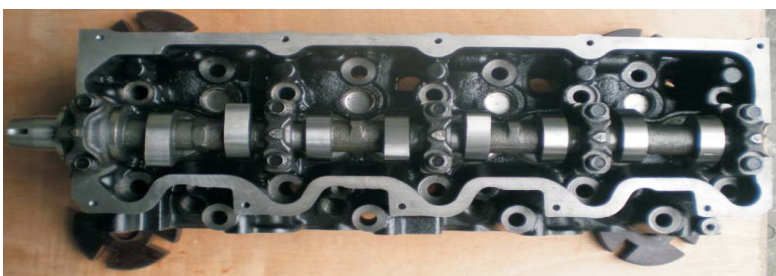
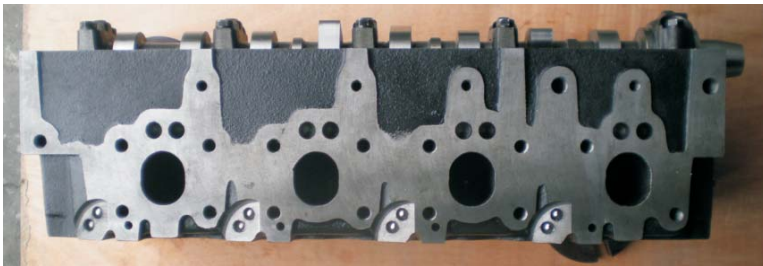

# CYLINDER HEAD ASSY

TOYOTA

ISO9001:2000/TS16949

AMC NO.	OEM NO.	ENGINE	VALVE/CM <sup>3</sup>	APPLICATION
909 054	11101-54150	5L	8 2.0	Hi-Lux /Dyna / HiAce

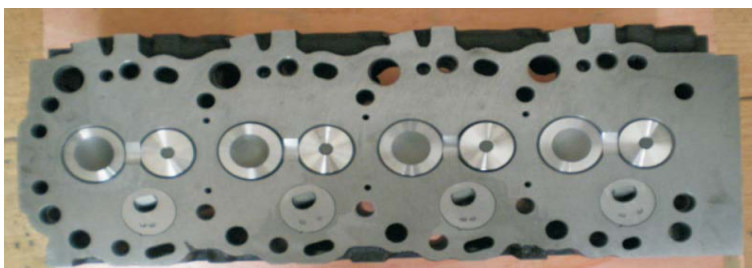
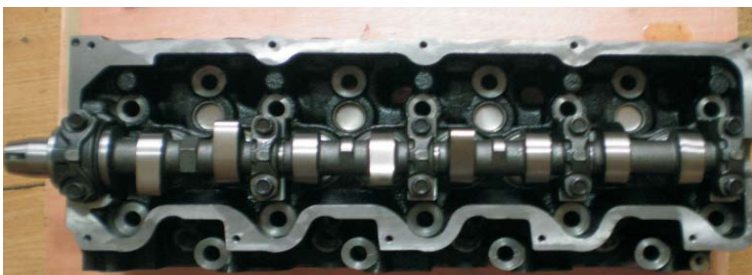

# CYLINDER HEAD ASSY

V W

ISO9001:2000/TS16949

AMC NO.	OEM NO.	ENGINE	VALVE/CM <sup>3</sup>	APPLICATION
908 034	11101-54150	AAB	10 2.4T	TRANSPORTER

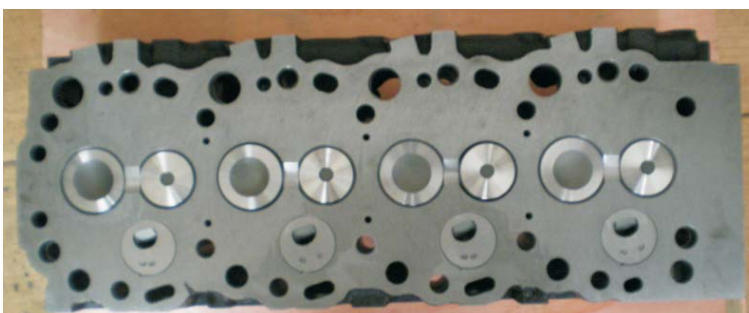
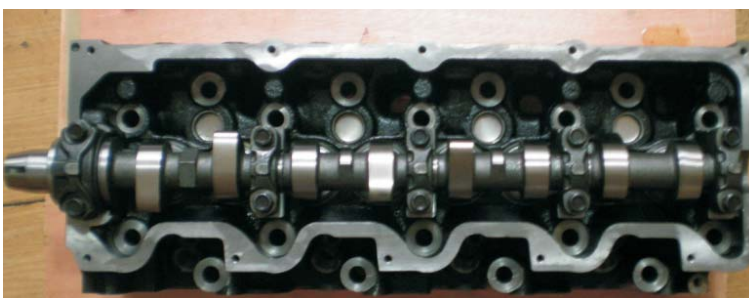
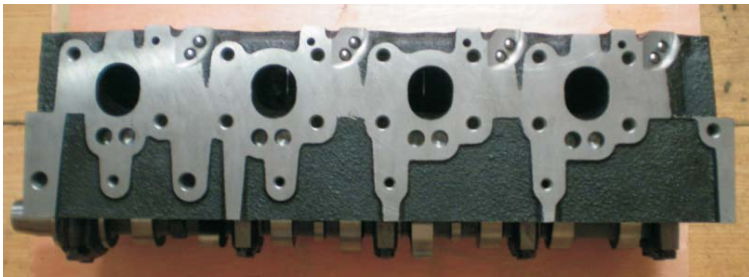

# CYLINDER HEAD ASSY

VW

ISO9001:2000/TS16949

AMC NO.	OEM NO.	ENGINE	VALVE/CM <sup>3</sup>	APPLICATION
908 052	028 103 351B	AAZ-8	8 1.9TD	80TD AUDI Golf TD TOLEDO LBIZA VentoTD PASSAT B5

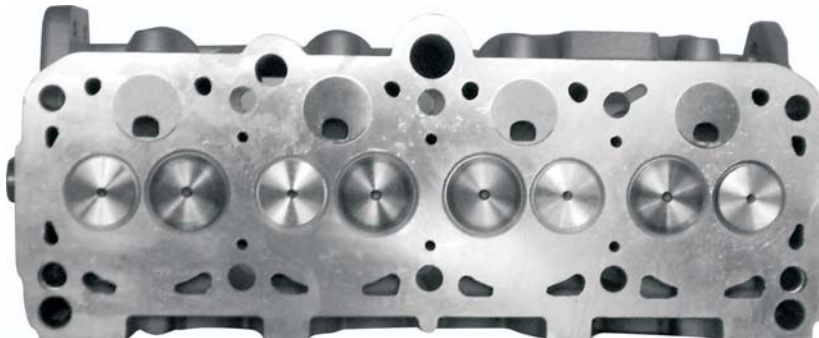
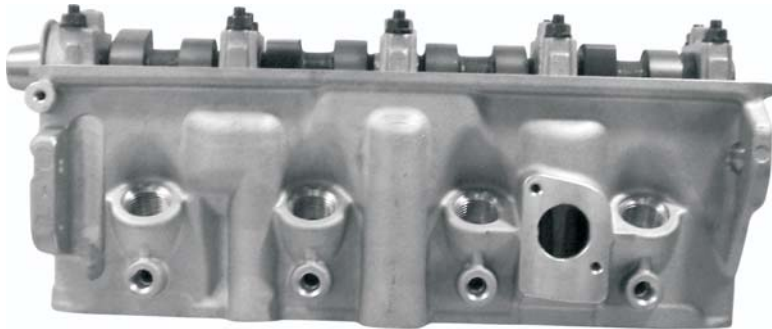
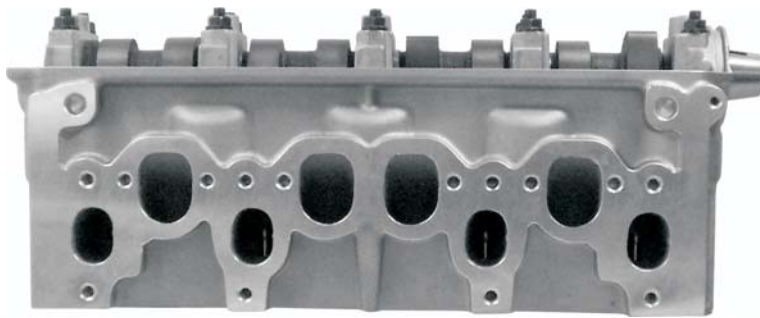

# CYLINDER HEAD ASSY

VW

ISO9001:2000/TS16949

AMC NO.	OEM NO.	ENGINE	VALVE/CM <sup>3</sup>	APPLICATION
908 059	028 103 351E	ABL-8	8 1.9TD	T4/TD

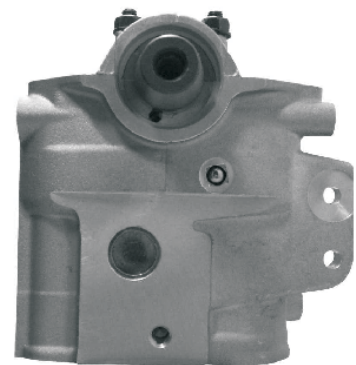
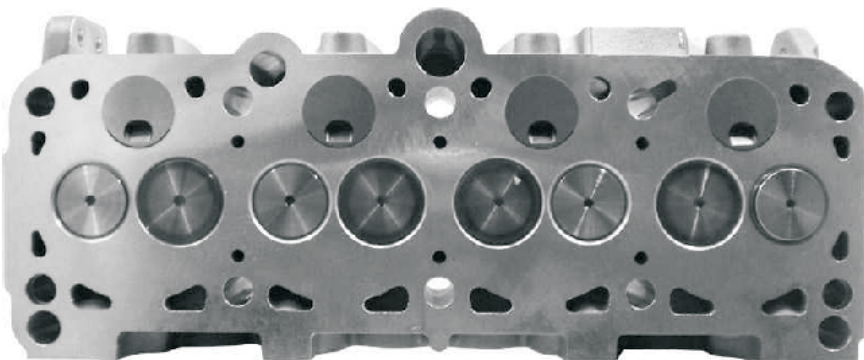
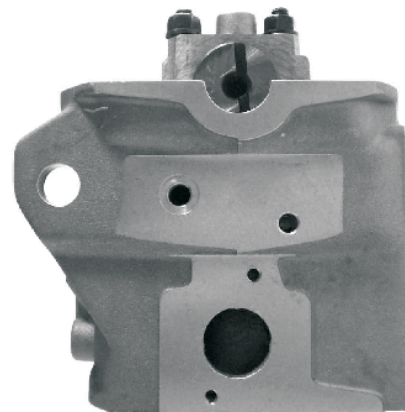
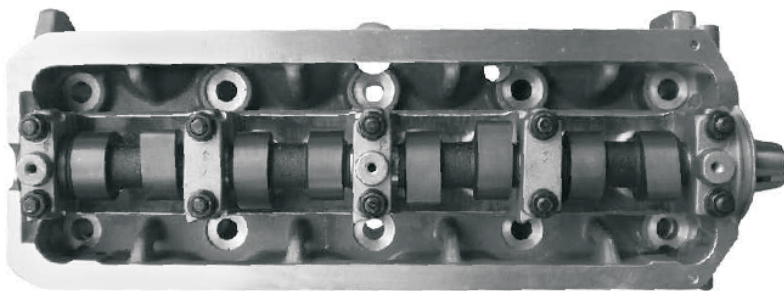
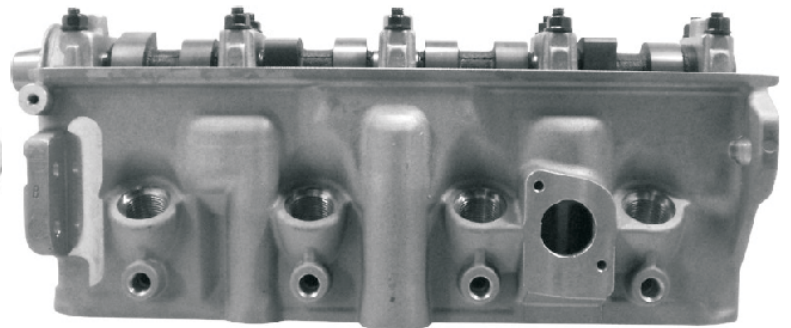

# CYLINDER HEAD ASSY

VW

ISO9001:2000/TS16949

AMC NO.	OEM NO.	ENGINE	VALVE/CM <sup>3</sup>	APPLICATION
908 032	028103351D	1Y-8	8 1.9TD	GOLF D VENTO D PASSAT

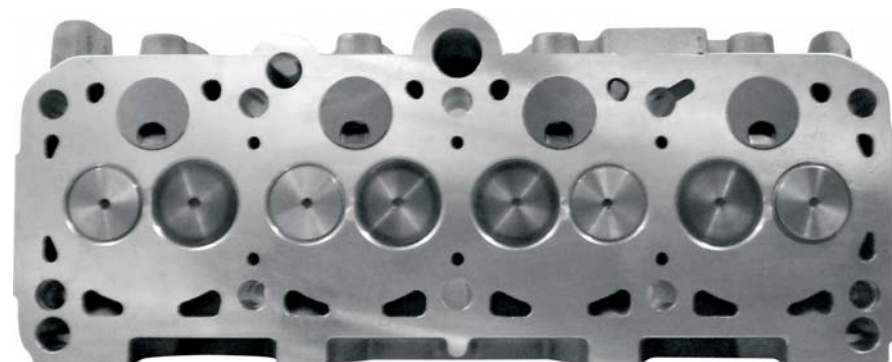

# CYLINDER HEAD ASSY

VW

ISO9001:2000/TS16949

AMC NO.	OEM NO.	ENGINE	VALVE/CM <sup>3</sup>	APPLICATION
908 515	ME202621	4M40	8 2.8D	MOTERO PAJERO GLX/GLS

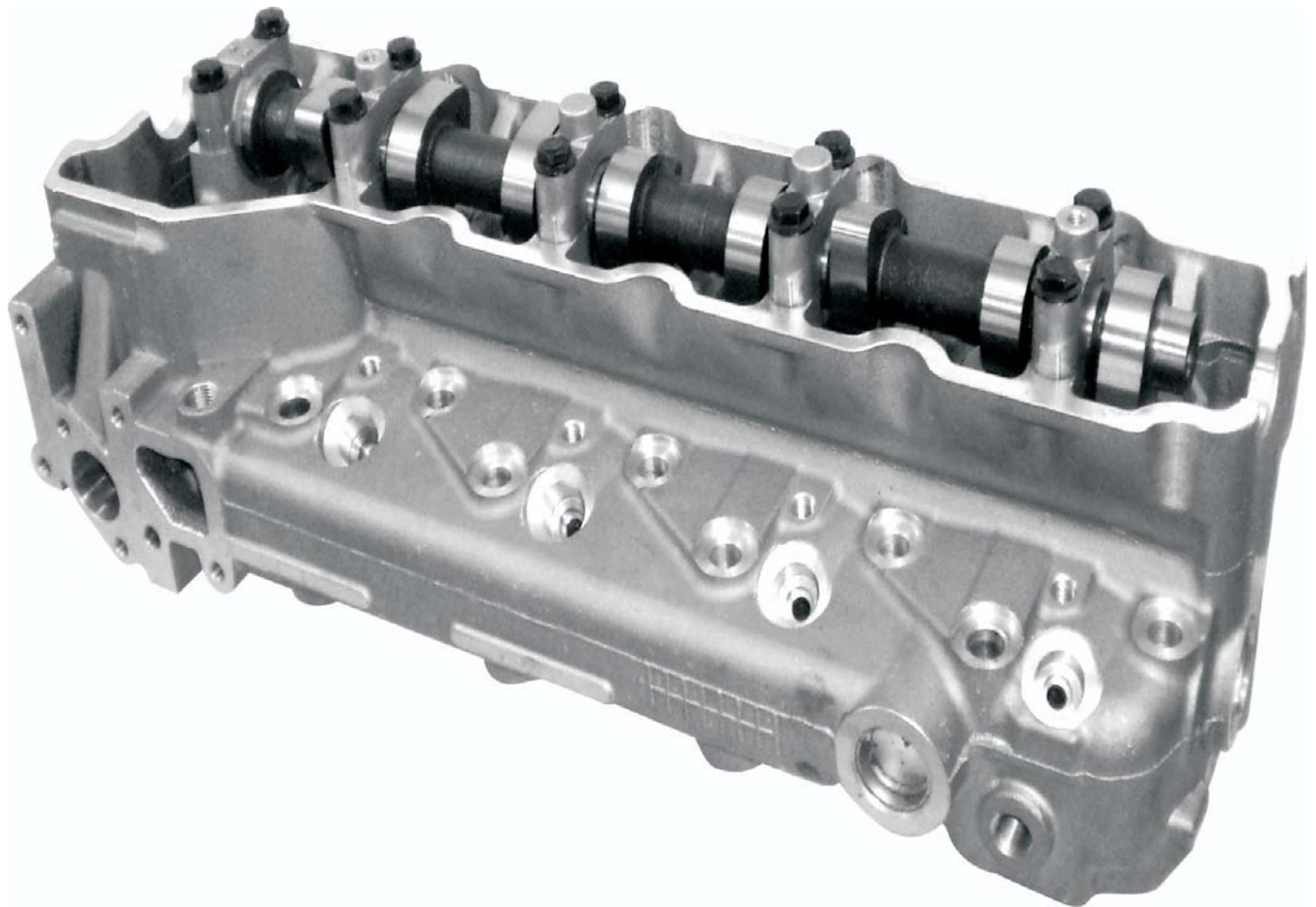



# CYLINDER HEAD ASSY

V W

ISO9001:2000/TS16949

AMC NO.	OEM NO.	ENGINE	VALVE/CM <sup>3</sup>	APPLICATION
	22100-32680	4G64-8V	8 2.4	Galant L200/L300 Expo Pajero wagon Shogun Pick-up Space wagon Mighty Max



# CYLINDER HEAD ASSY

VW

ISO9001:2000/TS16949

AMC NO.	OEM NO.	ENGINE	VALVE/CM <sup>3</sup>	APPLICATION
	MD364215 MD307678 (L) MD307677 (R) MD319220 (R) MD319218 MD301620 MD182213	6G72-L	6 3.0	E-V43W/V33 STORM-K76T



# CYLINDER HEAD ASSY

VW

ISO9001:2000/TS16949

AMC NO.	OEM NO.	ENGINE	VALVE/CM <sup>3</sup>	APPLICATION
	MD364215 MD307678 (L) MD307677 (R) MD319220 (R) MD319218 MD301620 MD182213	6G72-R	6 3.0	E-V43W/V33 STORM-K76T



# CYLINDER HEAD ASSY

V W

ISO9001:2000/TS16949

AMC NO.	OEM NO.	ENGINE	VALVE/CM <sup>3</sup>	APPLICATION
908 519	1005A560 1005B452 1005B453	4D56U	16 2.5TD	L200/L200 CR Triton Strada Pajero Sport Montero Sport Challenger Nativa



# CYLINDER HEAD ASSY

VW

ISO9001:2000/TS16949

AMC NO.	OEM NO.	ENGINE	VALVE/CM <sup>3</sup>	APPLICATION
908 750	R2L1-10-100 R263-10-100J/S R263-10-100E R263-10-100	R2	8 2.2D 2.0TD	323/626 E2200 B 2200/PREMACY CAPELLA /BONGO COSMO 2000

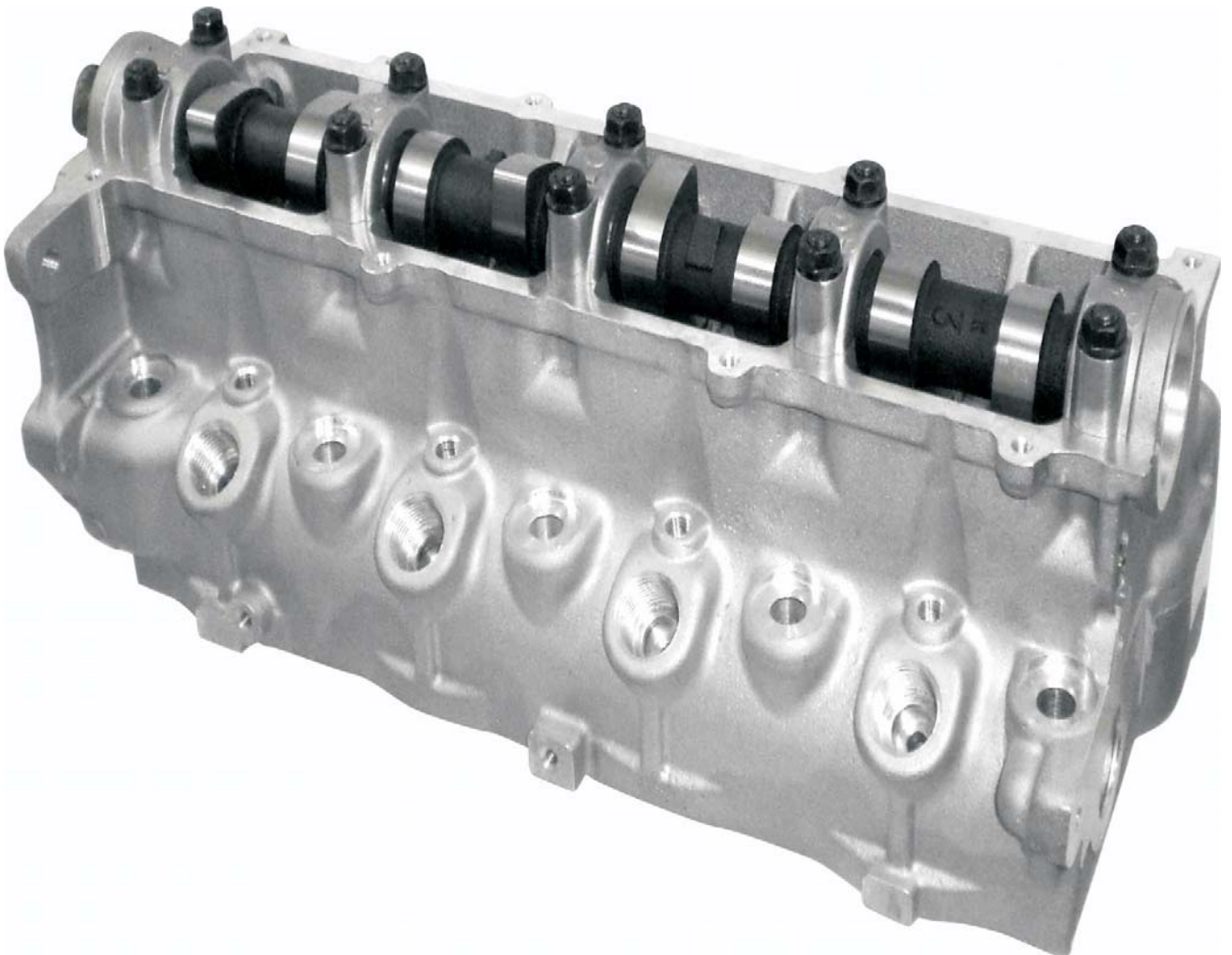

# CYLINDER HEAD ASSY

VW

ISO9001:2000/TS16949

AMC NO.	OEM NO.	ENGINE	VALVE/CM <sup>3</sup>	APPLICATION
908 744 908 745 908 747	WL 01-10-100G WL 11 10 100E WL 31 10 100H	WLT	12 2.5TD	MPV B2500

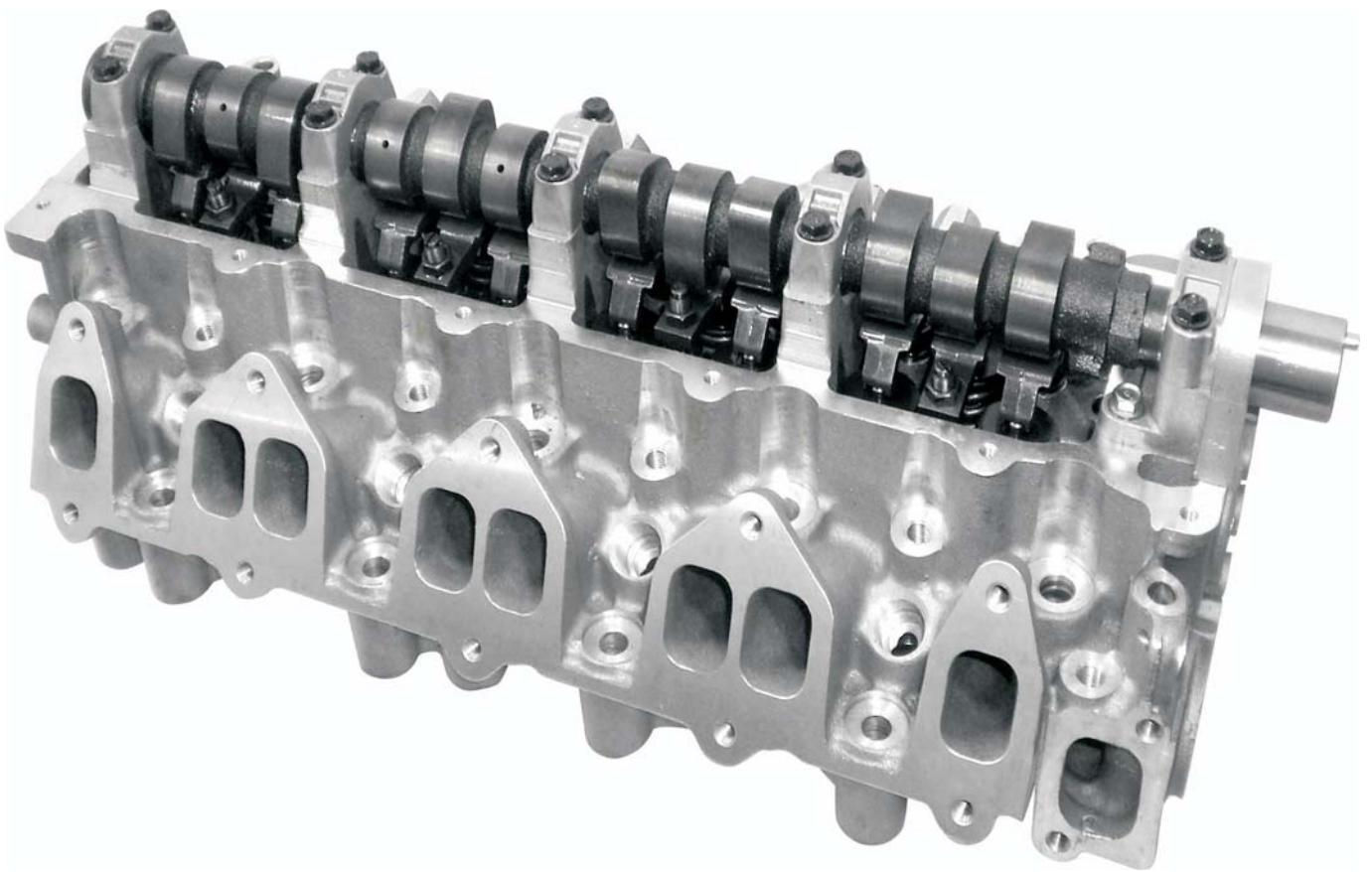

# CYLINDER HEAD ASSY

VW

ISO9001:2000/TS16949

AMC NO.	OEM NO.	ENGINE	VALVE/CM <sup>3</sup>	APPLICATION
	11101-75022	2RZ	8 2.4	TCR/TACOMA

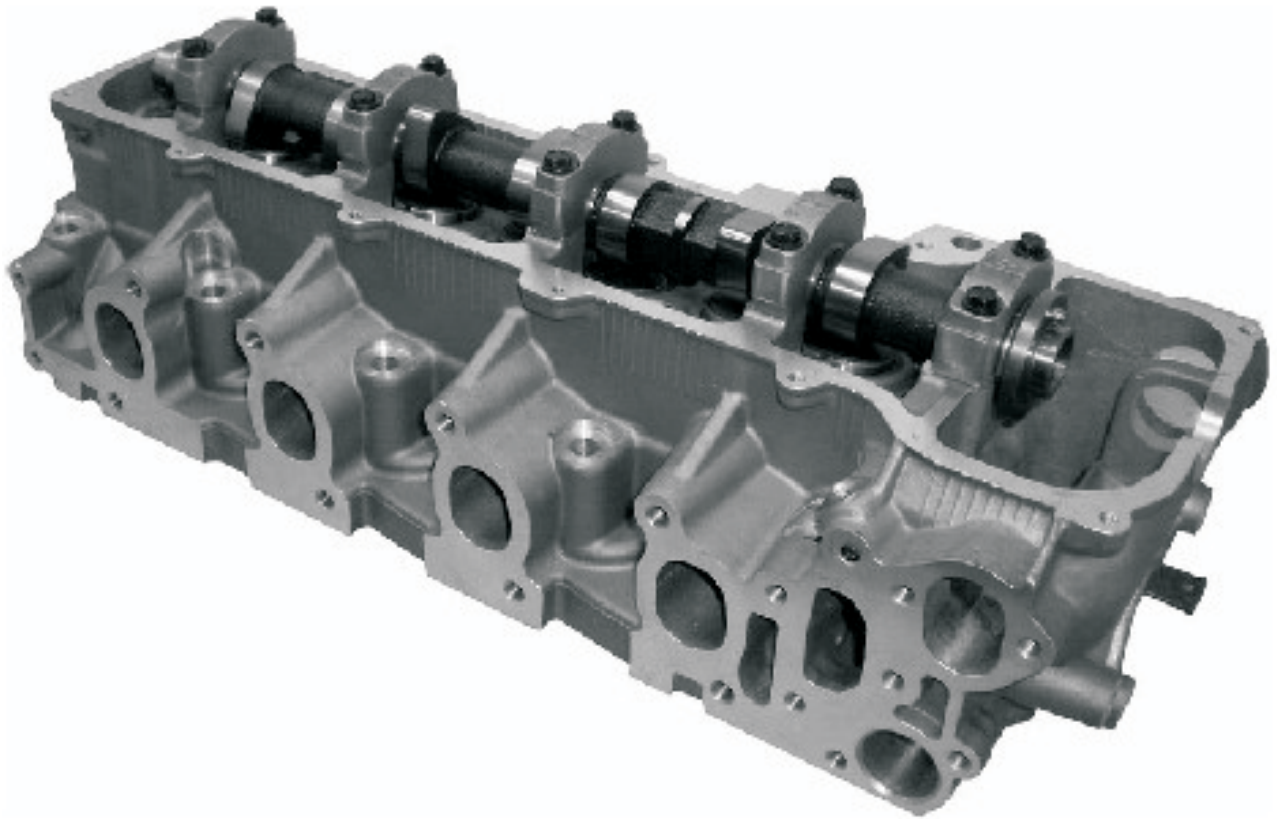

# CYLINDER HEAD ASSY

V W

ISO9001:2000/TS16949

AMC NO.	OEM NO.	ENGINE	VALVE/CM <sup>3</sup>	APPLICATION
909 052	11101-54111	2L2	8 2.0	Hi-Lux 2400

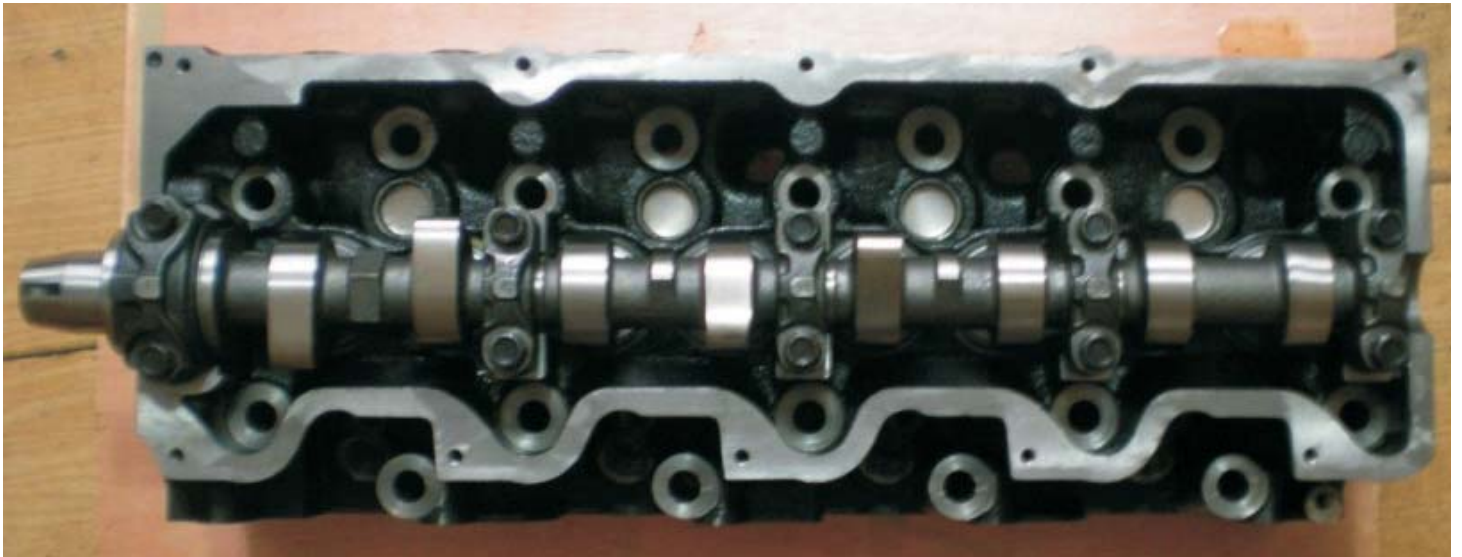



# CYLINDER HEAD ASSY

VW

ISO9001:2000/TS16949

AMC NO.	OEM NO.	ENGINE	VALVE/CM <sup>3</sup>	APPLICATION
909 056	11101-54121 11101-54160	2LT	8 2.0	Hi-Lux 2400 Dyna HiAce

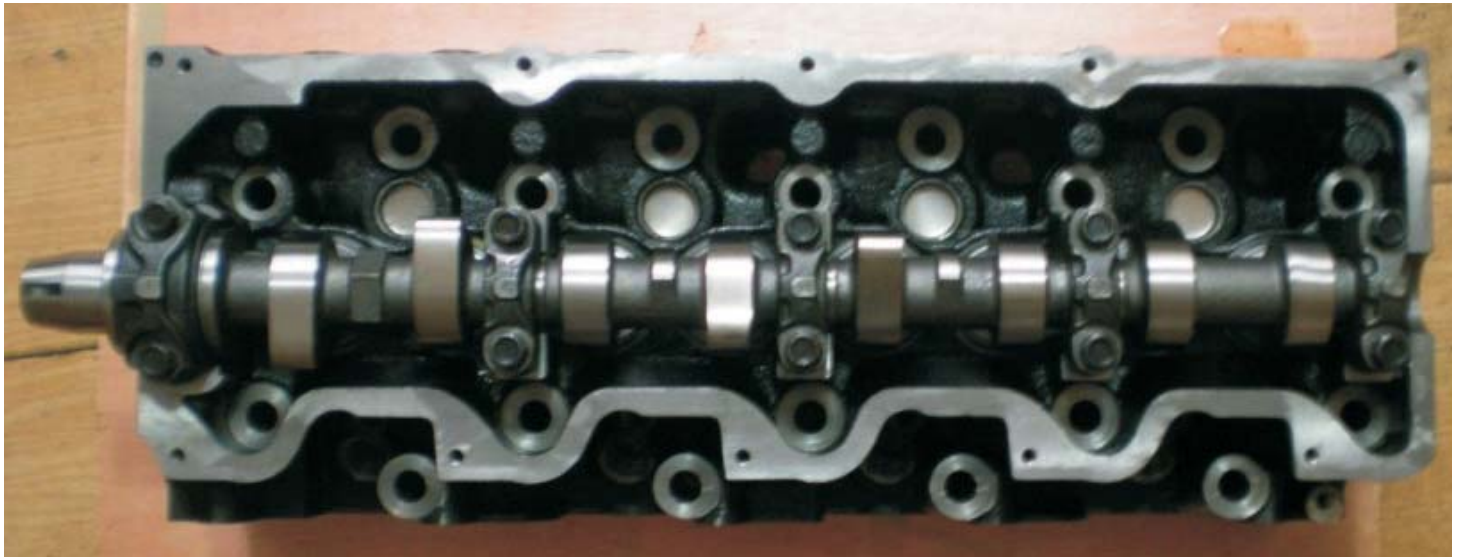

# CYLINDER HEAD ASSY

VW

ISO9001:2000/TS16949

AMC NO.	OEM NO.	ENGINE	VALVE/CM <sup>3</sup>	APPLICATION
908 783	11101-30050 11101-30030 11101-30031 11101-30032	1KD-FTV	16 3.0TDI	LAND Cruiser HI-LUK

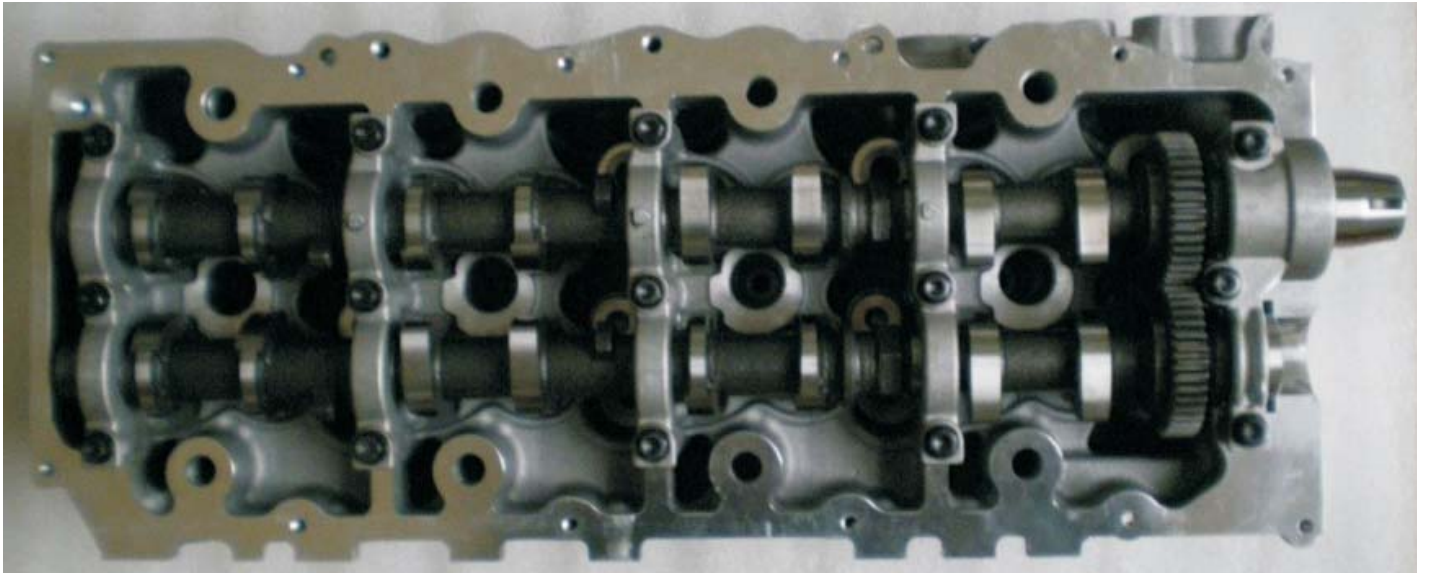

# CYLINDER HEAD ASSY

VW

ISO9001:2000/TS16949

AMC NO.	OEM NO.	ENGINE	VALVE/CM <sup>3</sup>	APPLICATION
908 784	11101-30040 11101-30041 11101-30060 11101-30042 11101-30070 11101-OL050 11101-30071	2KD-FTV	16 2.5TDI 2494	HI-LUK / HI-ACE DYNA 150

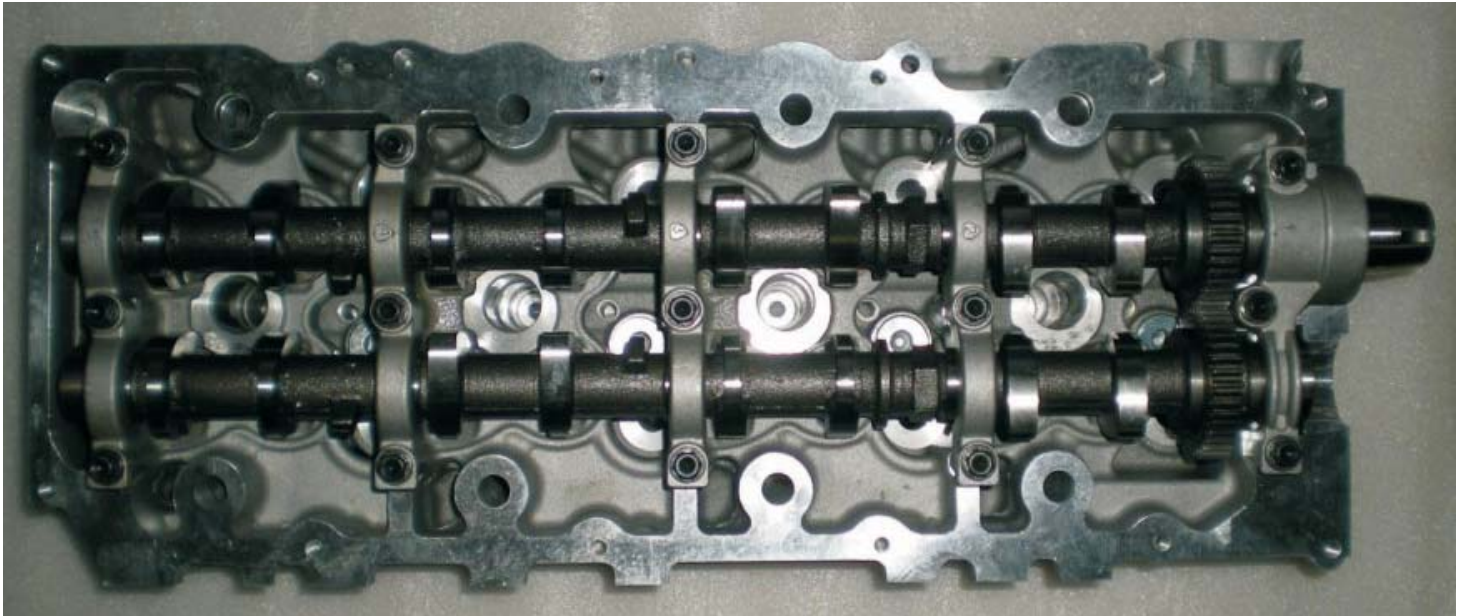

# CYLINDER HEAD ASSY

VW

ISO9001:2000/TS16949

AMC NO.	OEM NO.	ENGINE	VALVE/CM <sup>3</sup>	APPLICATION
908 781	11101-64390 11101-64132	3C-TE 2C-TE	8 2.0 D 1975 2.2D 2184	Avensis Carina Picnic



# CYLINDER HEAD ASSY

VW

ISO9001:2000/TS16949

AMC NO.	OEM NO.	ENGINE	VALVE/CM <sup>3</sup>	APPLICATION
	11101-75200 11101-75240	2TR-FE	16 2.7 2693CC	HILUX INNOVA FORTURNER TACOMA HIACE



# CYLINDER HEAD ASSY

VW

ISO9001:2000/TS16949

AMC NO.	OEM NO.	ENGINE	VALVE/CM <sup>3</sup>	APPLICATION
	11101-0C040	2TR-FE- EGR	16 2.7 2693CC	Hilux 150 Hiace 240 HiAceVan2007



# CYLINDER HEAD ASSY

VW

ISO9001:2000/TS16949

AMC NO.	OEM NO.	ENGINE	VALVE/CM <sup>3</sup>	APPLICATION
	11101-17012 11101-17010	1HZ	12 4.2D	Coaster 4.2D

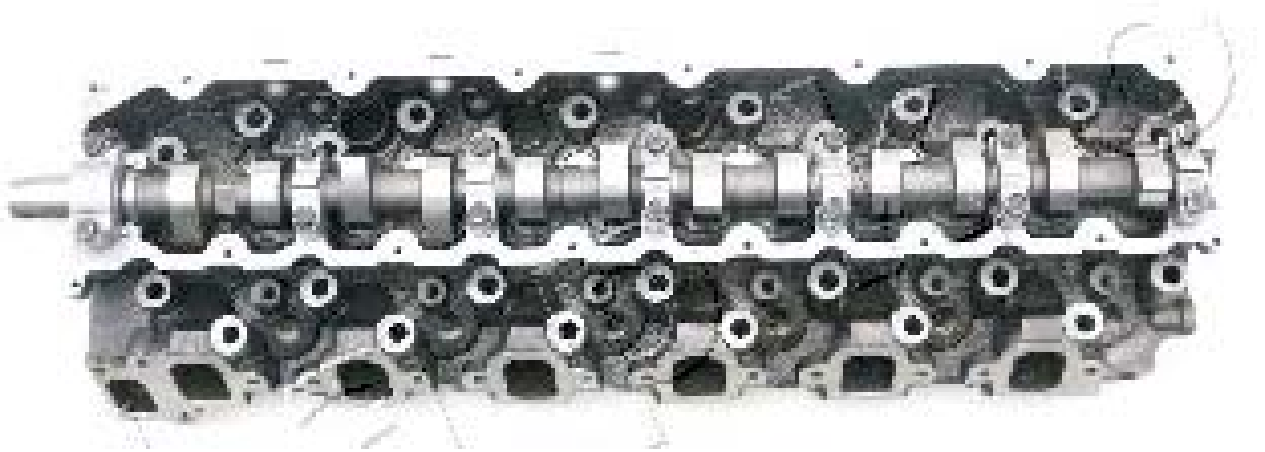

# CYLINDER HEAD ASSY

VW

ISO9001:2000/TS16949

AMC NO.	OEM NO.	ENGINE	VALVE/CM <sup>3</sup>	APPLICATION
908 034	074103351A 074103351D	AAB	10 2.4T	TRANSPORTER

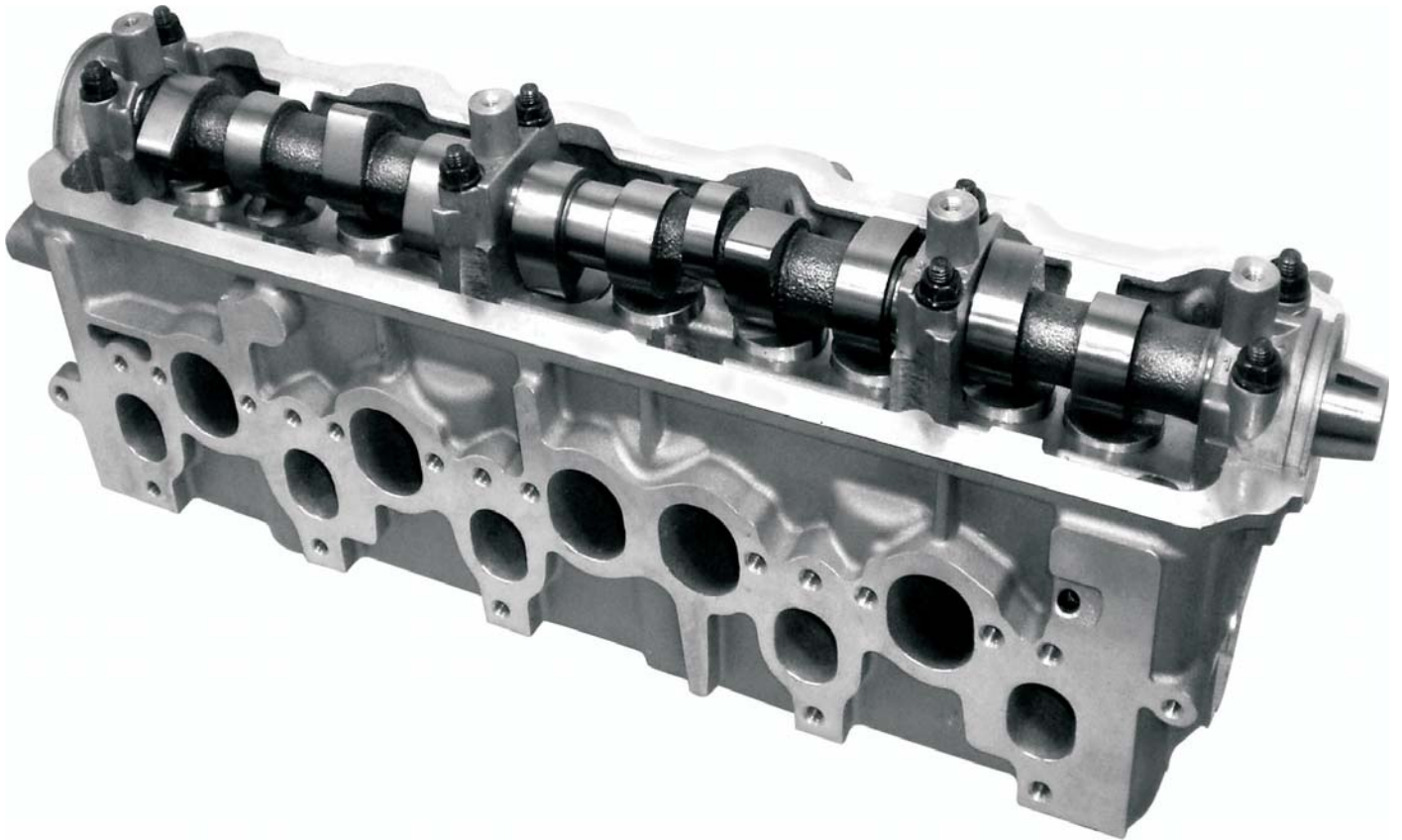



# CYLINDER HEAD ASSY

VW

ISO9001:2000/TS16949

AMC NO.	OEM NO.	ENGINE	VALVE/CM <sup>3</sup>	APPLICATION
910 029	058 103 351G 058 103 373D/G/R L06B 103 063AD	ANQ AWB BAF AWL DKB	20 1.8/1.6	PASSAP B5 BORA /GOFL AUDI A6 / AUDI A4

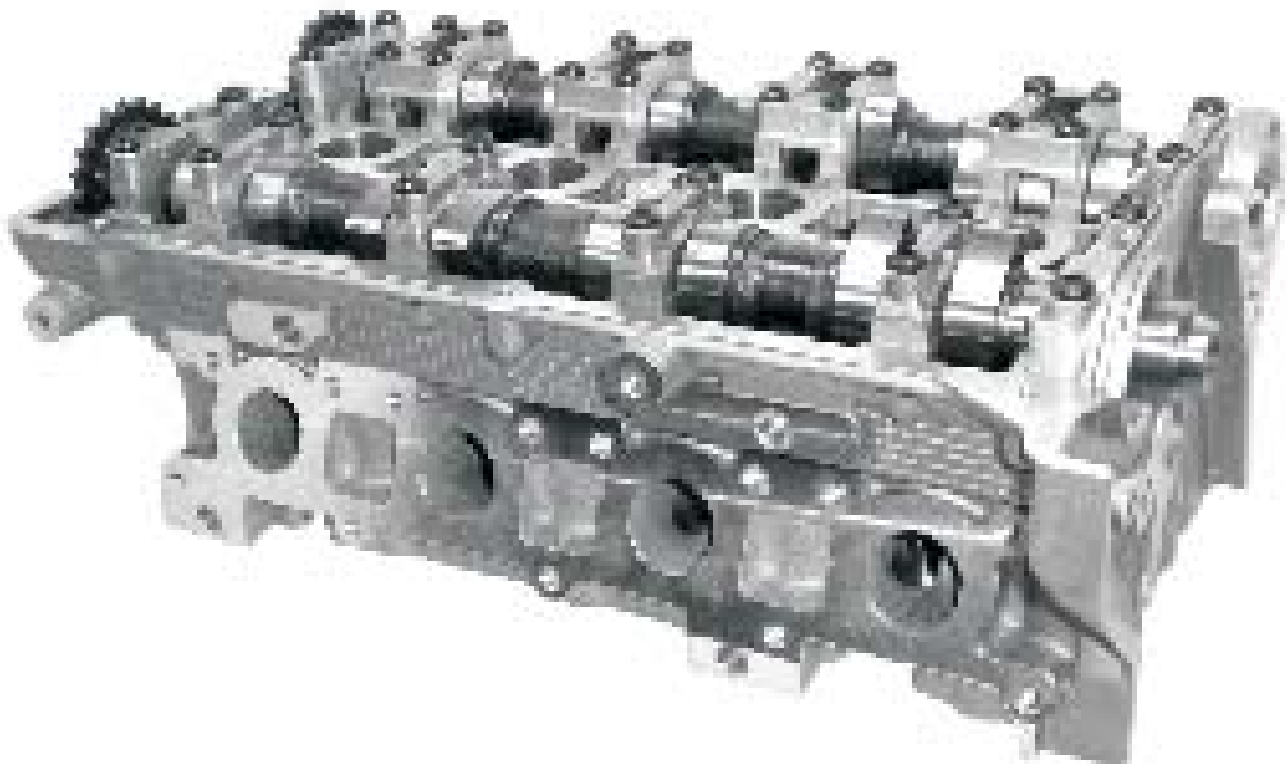

# CYLINDER HEAD ASSY

VW

ISO9001:2000/TS16949

AMC NO.	OEM NO.	ENGINE	VALVE/CM <sup>3</sup>	APPLICATION
910 028	058 103 351L 06A 103 351L 058 103 351E	ANQ AWB BAF AWL DKB	20 1.8T	PASSAP B5 BORA / GOFL AUDI A6 / AUDI A4

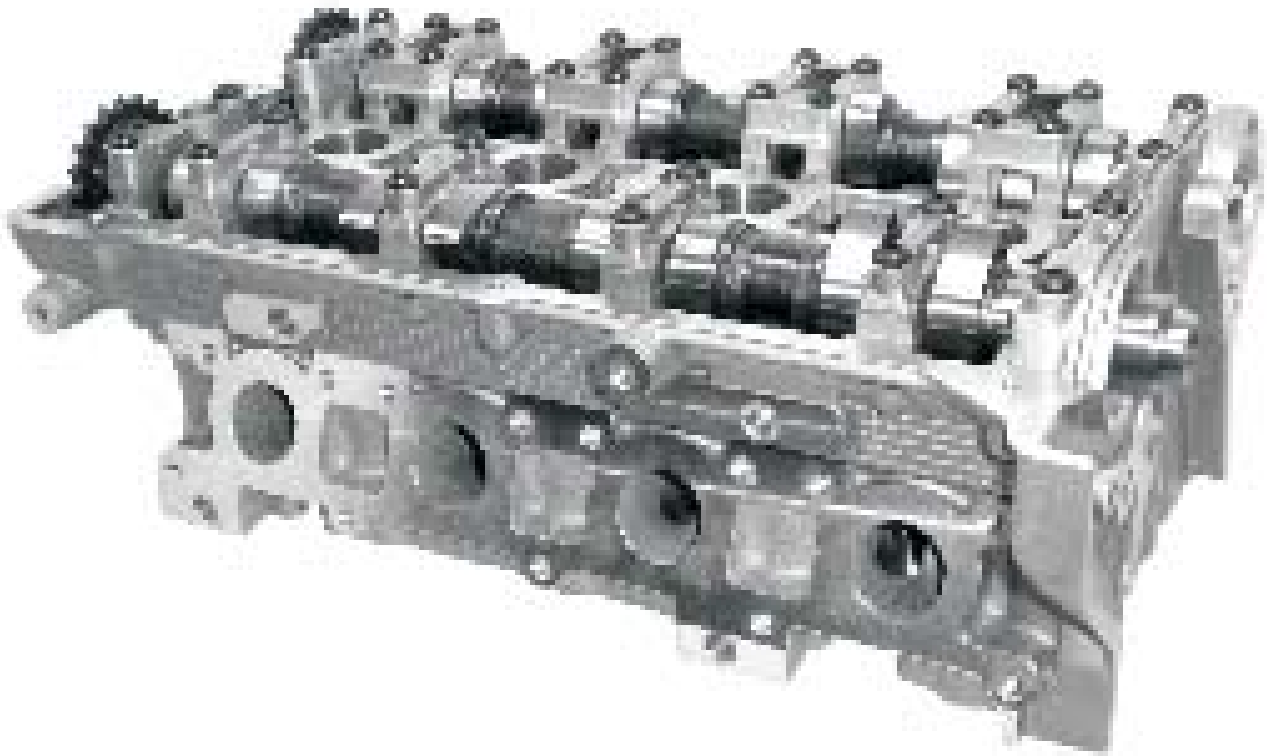

# CYLINDER HEAD ASSY

VW

ISO9001:2000/TS16949

AMC NO.	OEM NO.	ENGINE	VALVE/CM <sup>3</sup>	APPLICATION
908 039	028103351A	1X	8 1.9D	Transporter D Multivan Caravelle

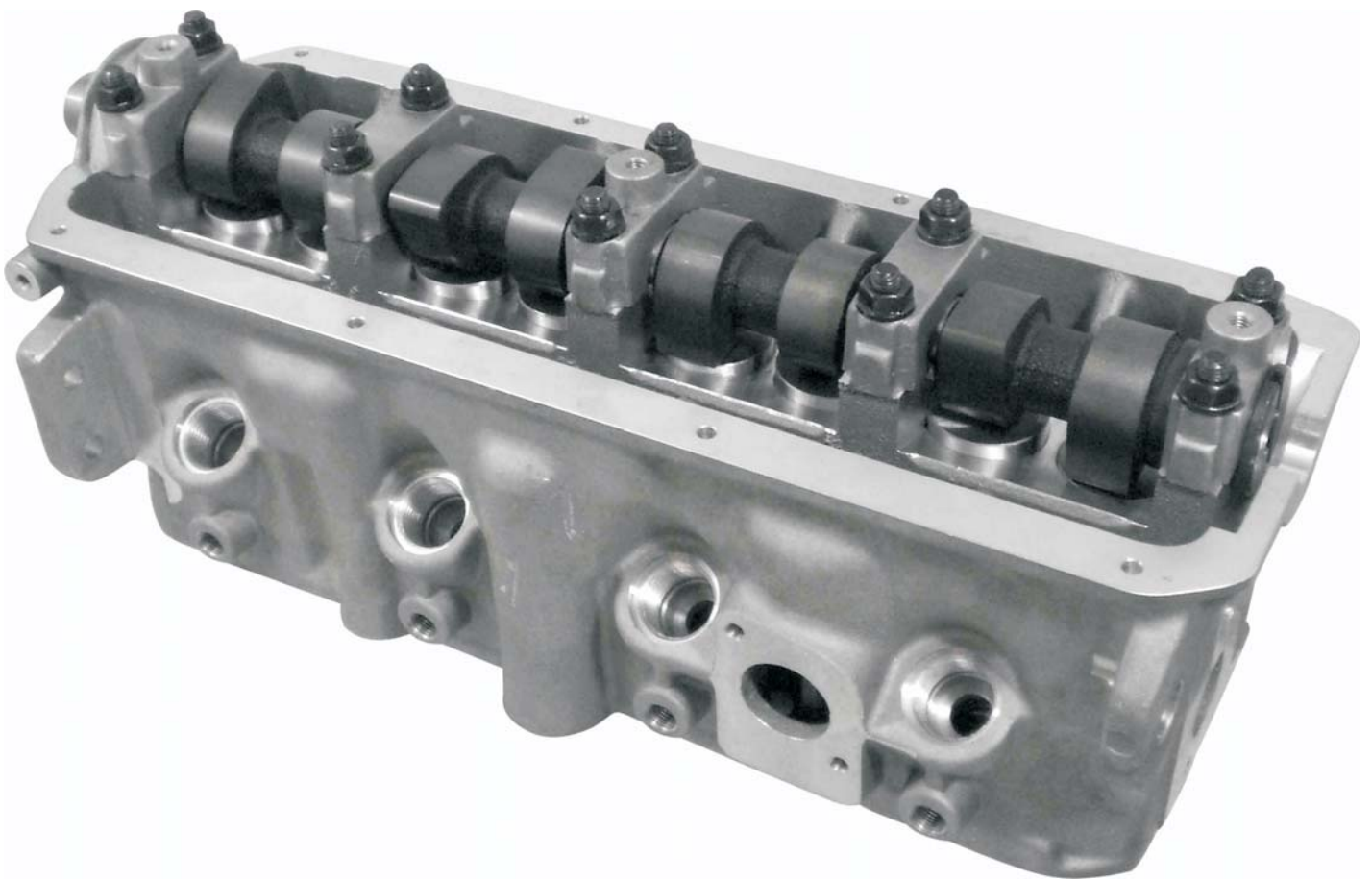

# CYLINDER HEAD ASSY

VW

ISO9001:2000/TS16949

AMC NO.	OEM NO.	ENGINE	VALVE/CM <sup>3</sup>	APPLICATION
908 051	028 103 351F	1Z-8	8 1.6D/TD	A4/A4 AVANT A4 AVANT AUTO A6 AUDI/GOLF/ SHARAN PASSAT/ VENTO VARIANT TDI

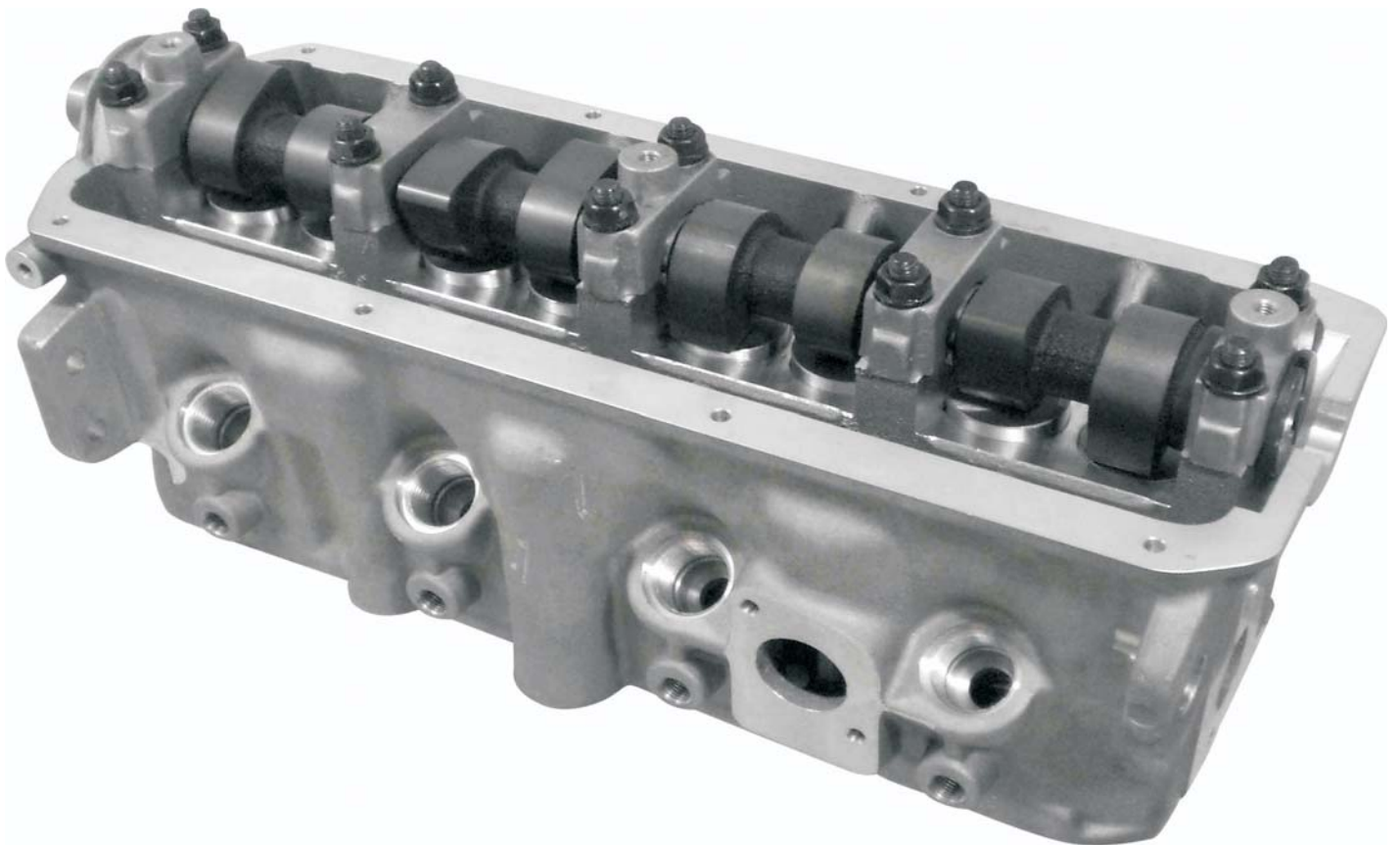

# CYLINDER HEAD ASSY

VW

ISO9001:2000/TS16949

AMC NO.	OEM NO.	ENGINE	VALVE/CM <sup>3</sup>	APPLICATION
908 703	038 103 351B 038 103 373E	AHF ASB AGR AGP AQM AYQ ALH	8 1.9TDI	OCTAVIA FABIA



BACK

# CYLINDER HEAD ASSY

VW

ISO9001:2000/TS16949

AMC NO.	OEM NO.	ENGINE	VALVE/CM <sup>3</sup>	APPLICATION
908 710	038 103 351	AHF AGR AGP ASY	8 1.9TDI	OCTAVIA FABIA



BACK

# CYLINDER HEAD ASSY

VW

ISO9001:2000/TS16949

AMC NO.	OEM NO.	ENGINE	VALVE/CM <sup>3</sup>	APPLICATION
	026 103 373AQ 026 103 353Q 026 103 353AQ	JV-8MM	8 1.6/1.8	SANTANA

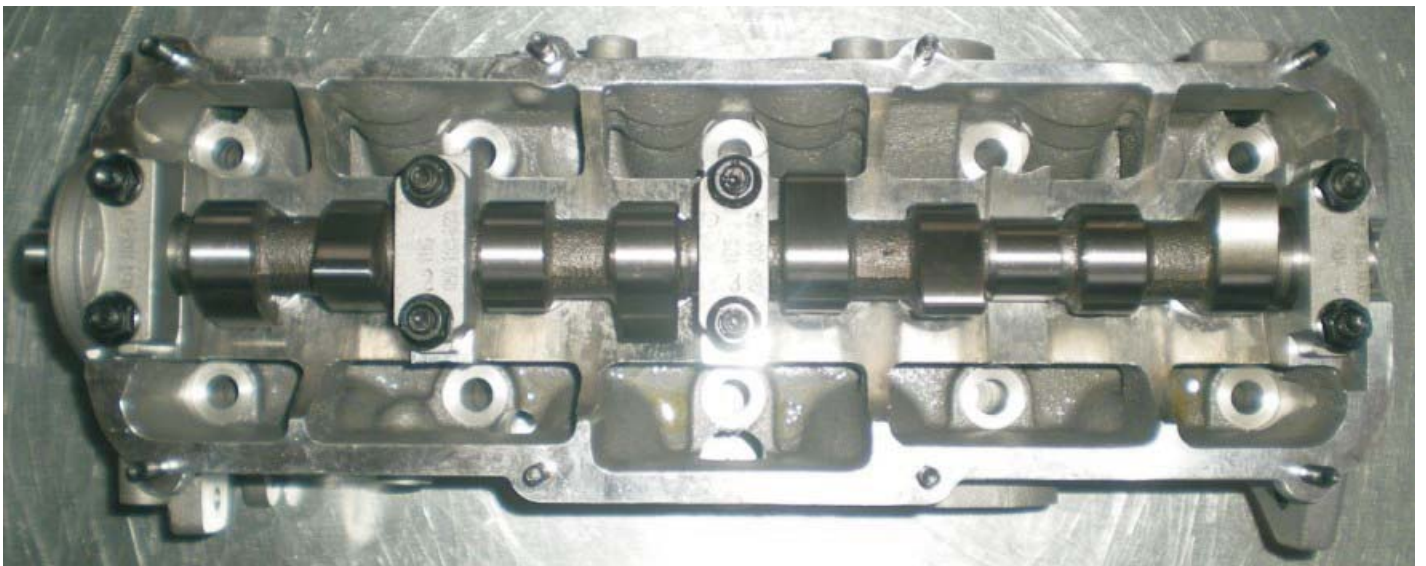

# CYLINDER HEAD ASSY

VW

ISO9001:2000/TS16949

AMC NO.	OEM NO.	ENGINE	VALVE/CM <sup>3</sup>	APPLICATION
	11041-20G13 11041-13F00	Z24 4S	8 2.4	D21

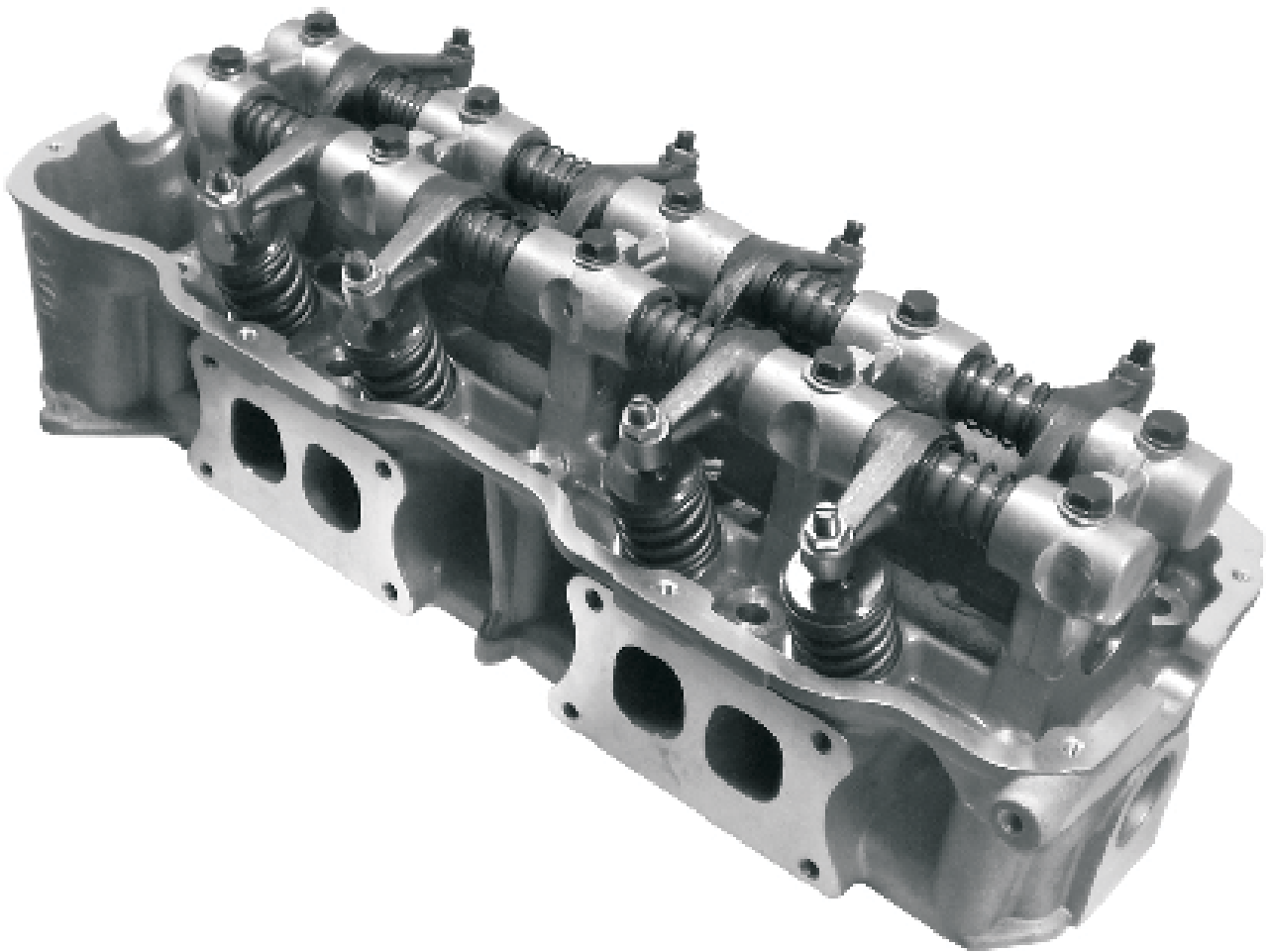



# CYLINDER HEAD ASSY

VW

ISO9001:2000/TS16949

AMC NO.	OEM NO.	ENGINE	VALVE/CM <sup>3</sup>	APPLICATION
908 796	7701061586	Zd3	16 3.0 CDTI 2953	Mascott

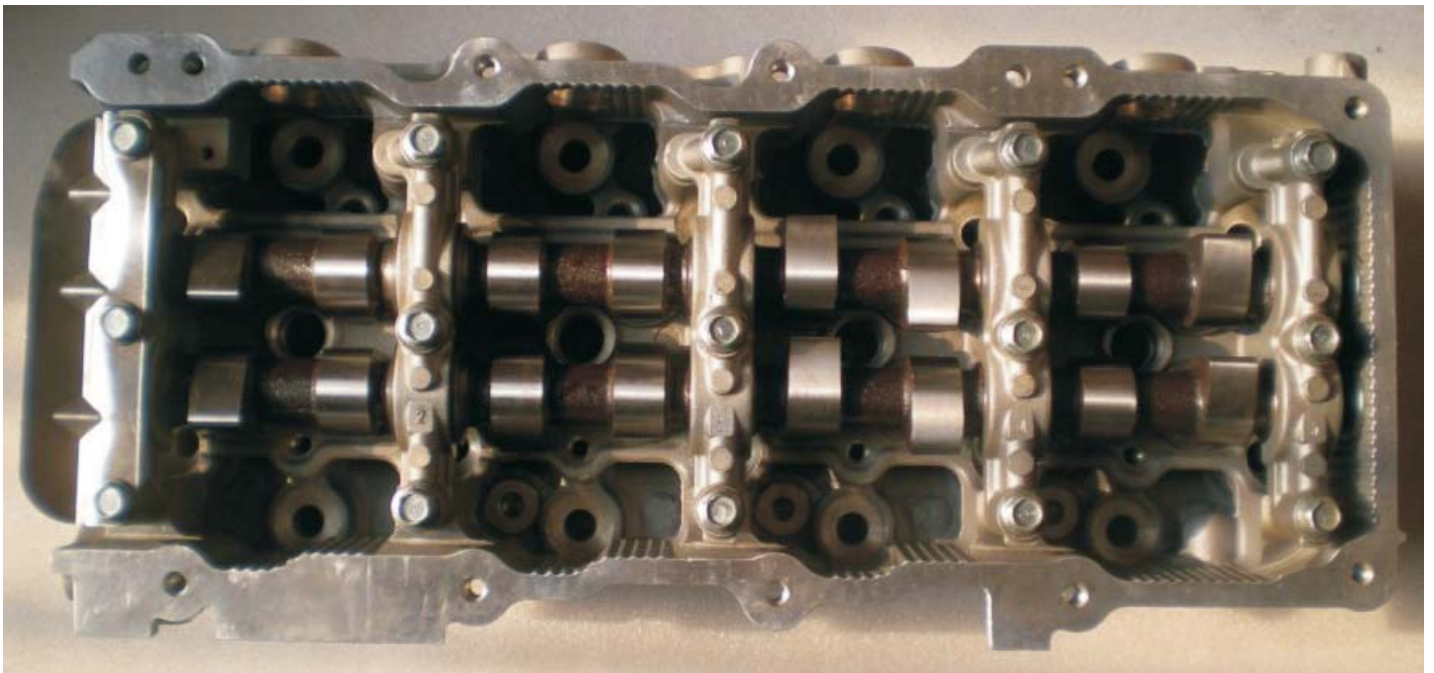

# CYLINDER HEAD ASSY

VW

ISO9001:2000/TS16949

AMC NO.	OEM NO.	ENGINE	VALVE/CM <sup>3</sup>	APPLICATION
908 557	7701061587 7701066984 7701068368	Zd3 A2	16 3.0 DTI 2953	MASTER

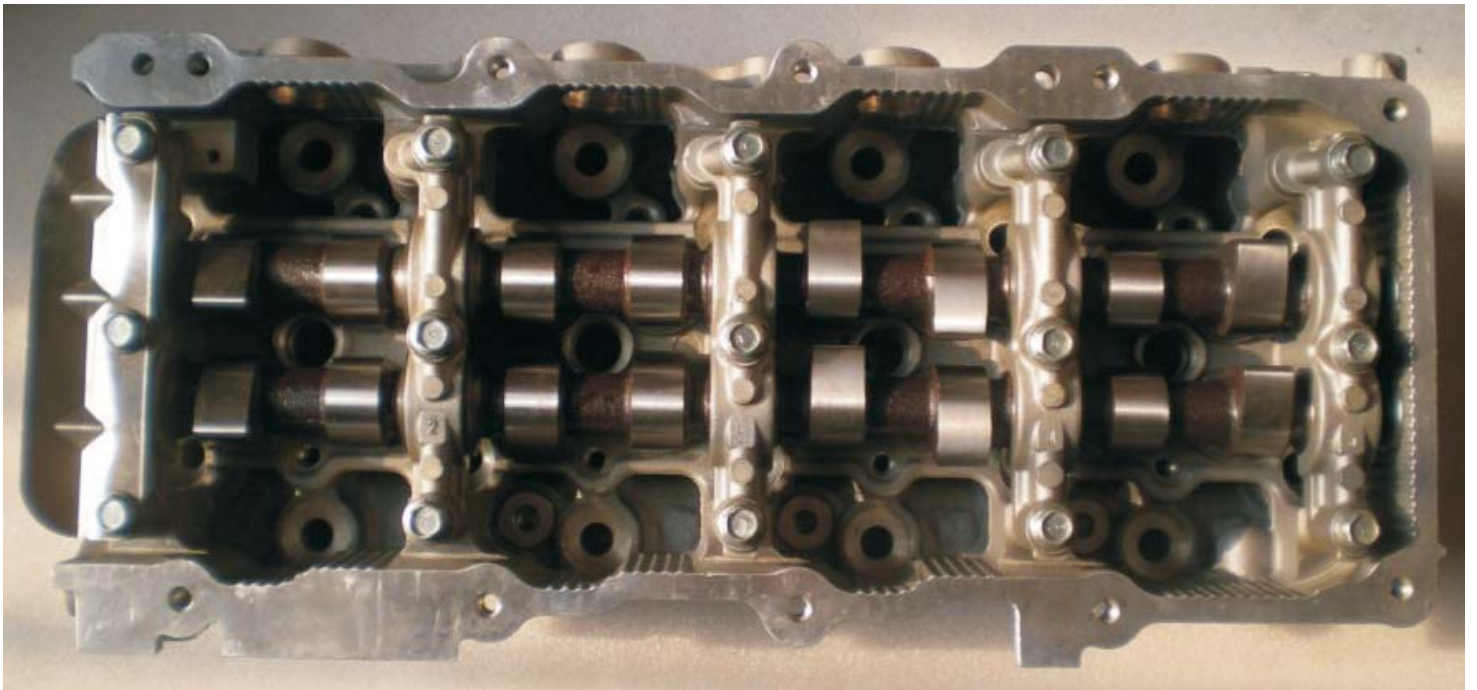

# CYLINDER HEAD ASSY

V W

ISO9001:2000/TS16949

AMC NO.	OEM NO.	ENGINE	VALVE/CM <sup>3</sup>	APPLICATION
908 509	11039-MA70A 11039-VZ20A 11039-VZ20B	Zd30 K5MT	16 3.0TDI 2953	ATLEON CABSTAR

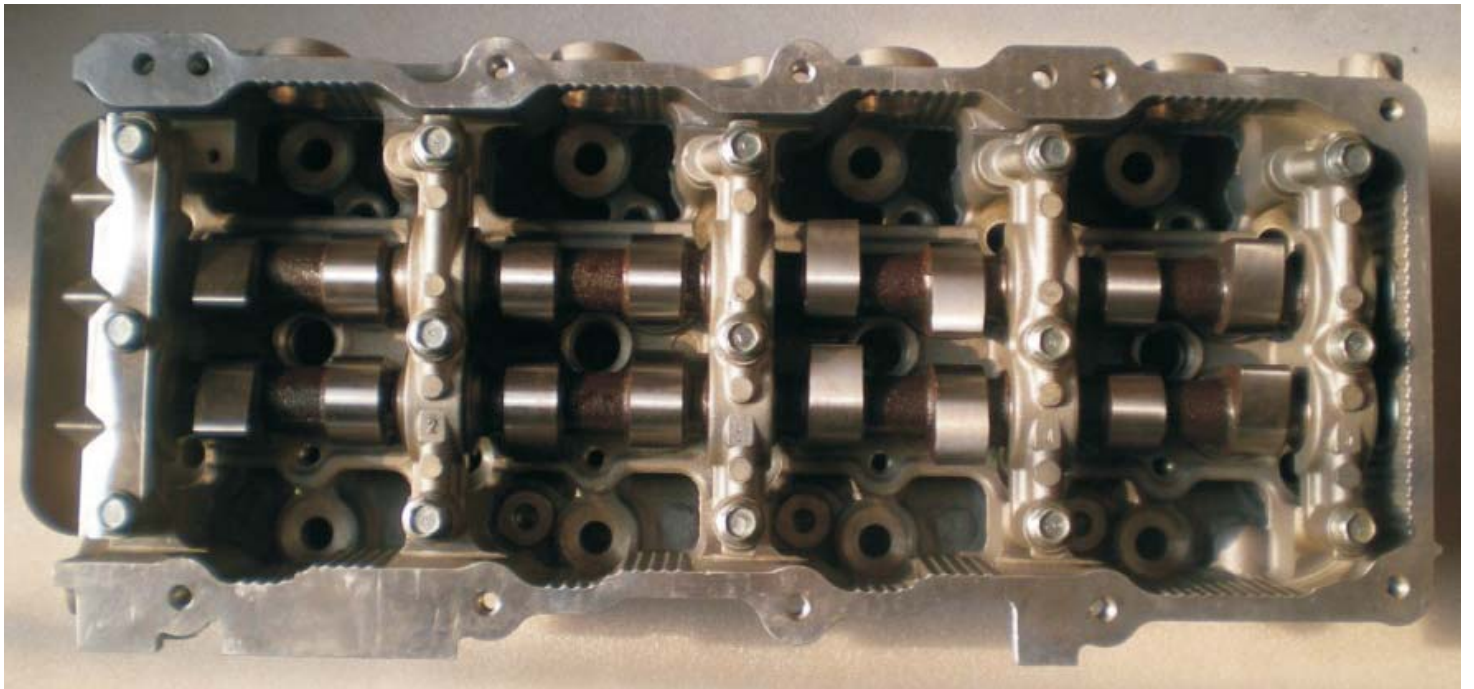

# CYLINDER HEAD ASSY

VW

ISO9001:2000/TS16949

AMC NO.	OEM NO.	ENGINE	VALVE/CM <sup>3</sup>	APPLICATION
908 505	11040-5M300 11040-5M302	Yd25	16 2.5D	NARAVA



# CYLINDER HEAD ASSY

VW

ISO9001:2000/TS16949

AMC NO.	OEM NO.	ENGINE	VALVE/CM <sup>3</sup>	APPLICATION
908 510	11039-EC00A 11039-EB30A 11040-EB30A 11040-EB300	Yd25	16 2.5DDTI	NARAVA

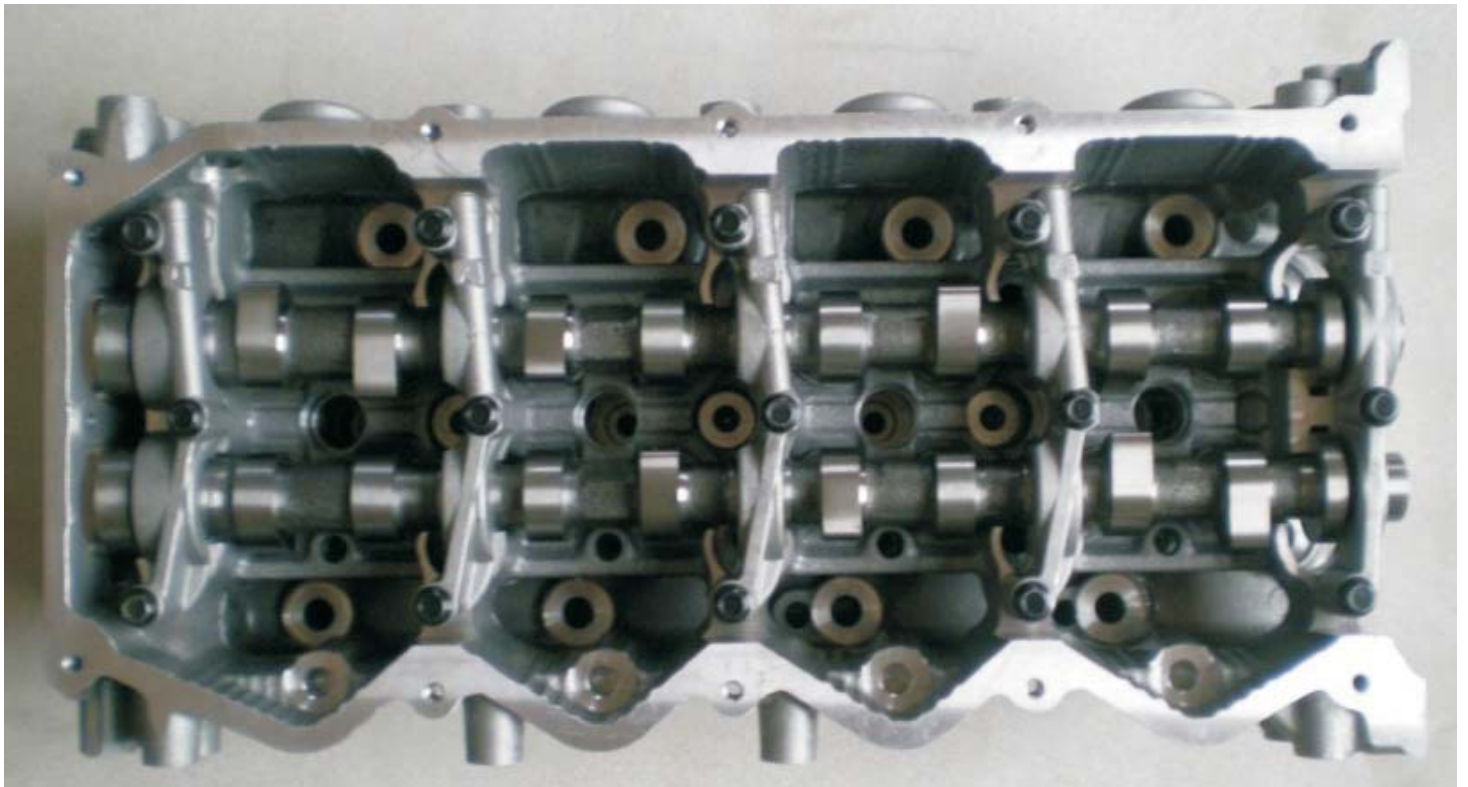

# CYLINDER HEAD ASSY

V W

ISO9001:2000/TS16949

AMC NO.	OEM NO.	ENGINE	VALVE/CM <sup>3</sup>	APPLICATION
	11040-VJ260	KA24DE	16 2.4	D22 PICK UP

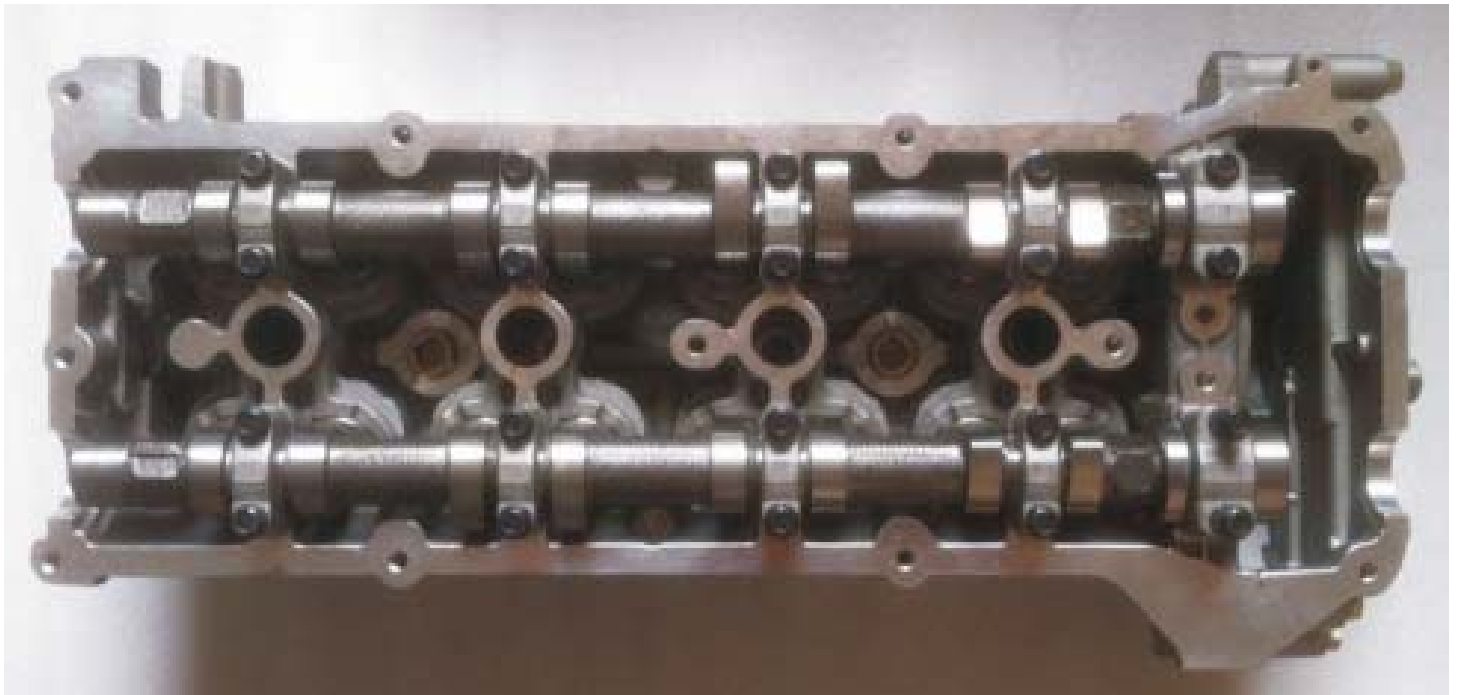

# CYLINDER HEAD ASSY

VW

ISO9001:2000/TS16949

AMC NO.	OEM NO.	ENGINE	VALVE/CM <sup>3</sup>	APPLICATION
908 501	11040-G9825	Rd28	12 2.8D	PATROL

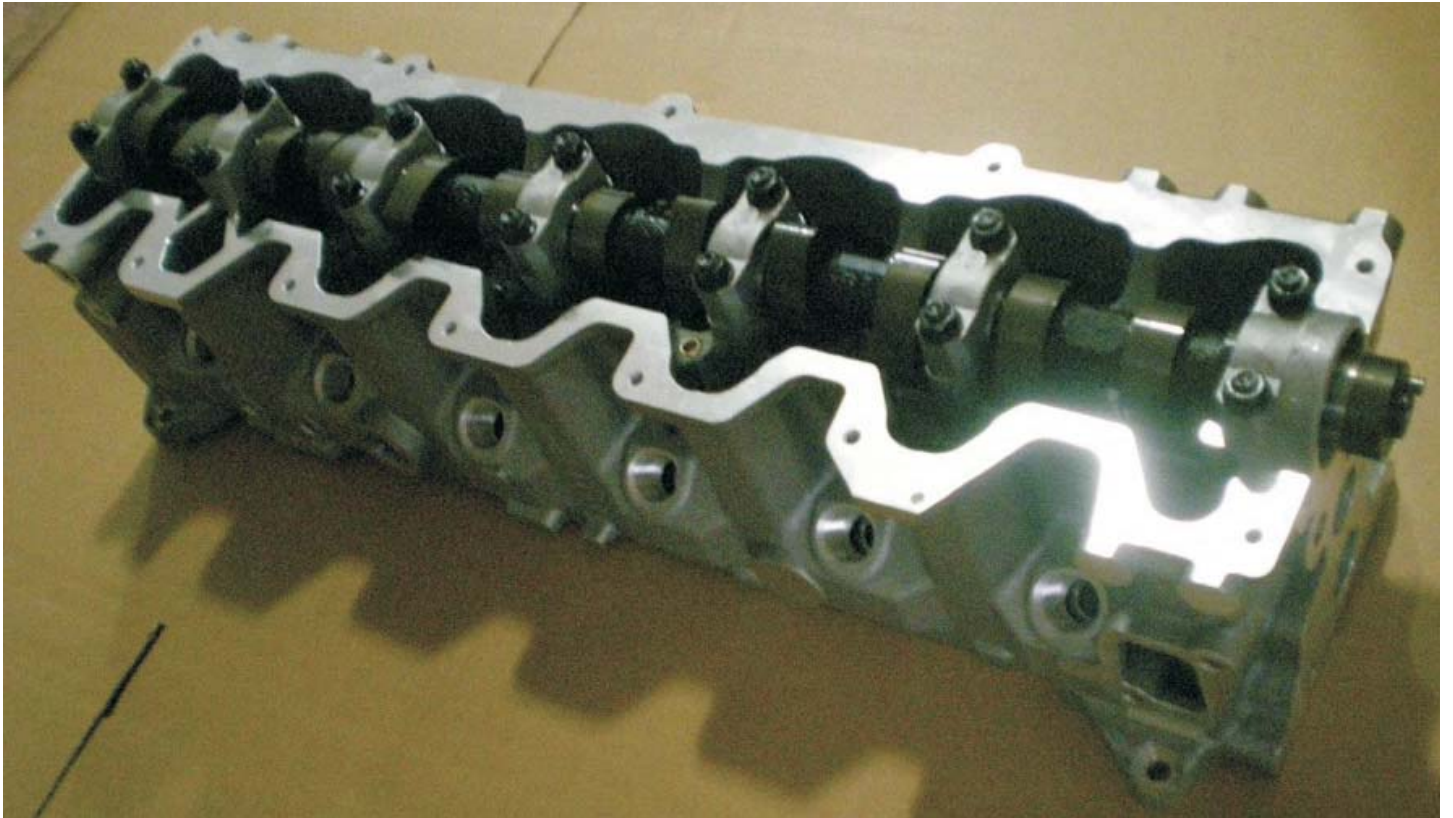

# CYLINDER HEAD ASSY

V W

ISO9001:2000/TS16949

AMC NO.	OEM NO.	ENGINE	VALVE/CM <sup>3</sup>	APPLICATION
	11039-44G01	Td25	8	

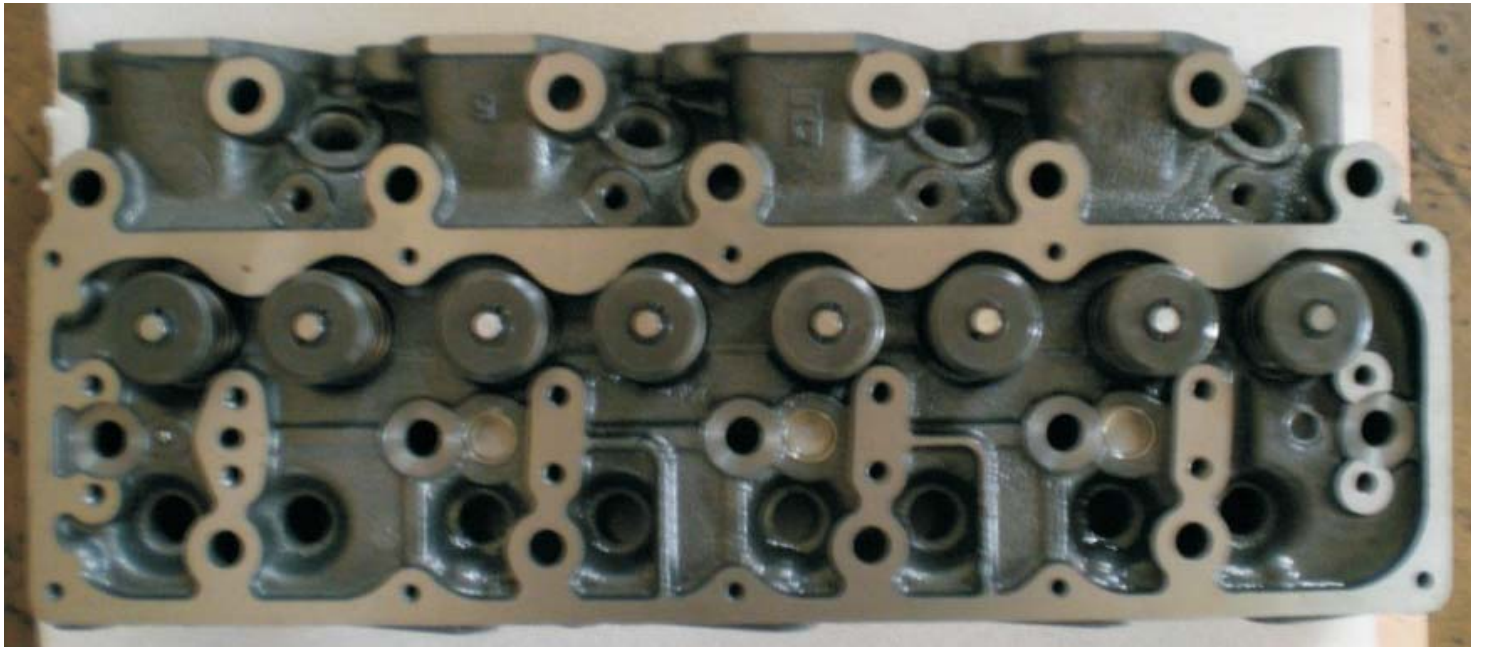



# CYLINDER HEAD ASSY

V W

ISO9001:2000/TS16949

AMC NO.	OEM NO.	ENGINE	VALVE/CM <sup>3</sup>	APPLICATION
909 011	11039-7F409 11039-7F403	TD27-T	12 2.7D/TD	Terrano Mistral Pathfinder

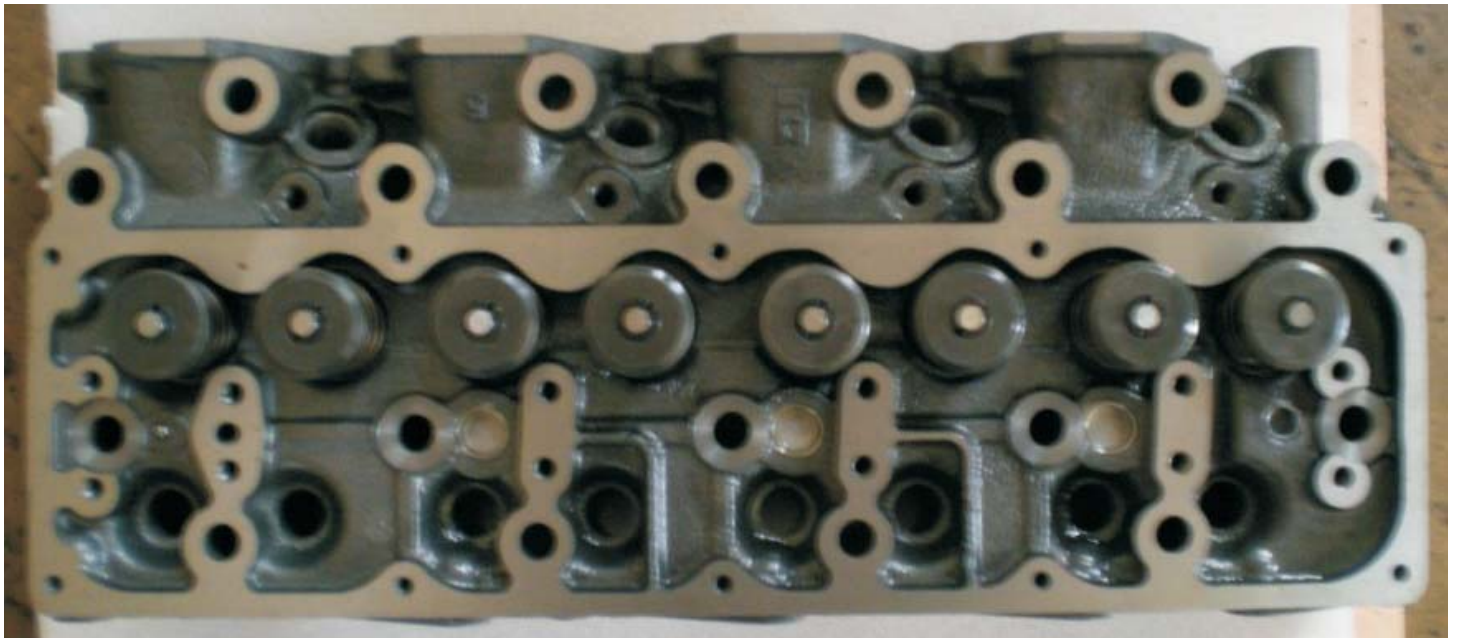

# CYLINDER HEAD ASSY

VW

ISO9001:2000/TS16949

AMC NO.	OEM NO.	ENGINE	VALVE/CM <sup>3</sup>	APPLICATION
	11039-43G03/ 43G06/45N01/ 40K02	Td27	8	

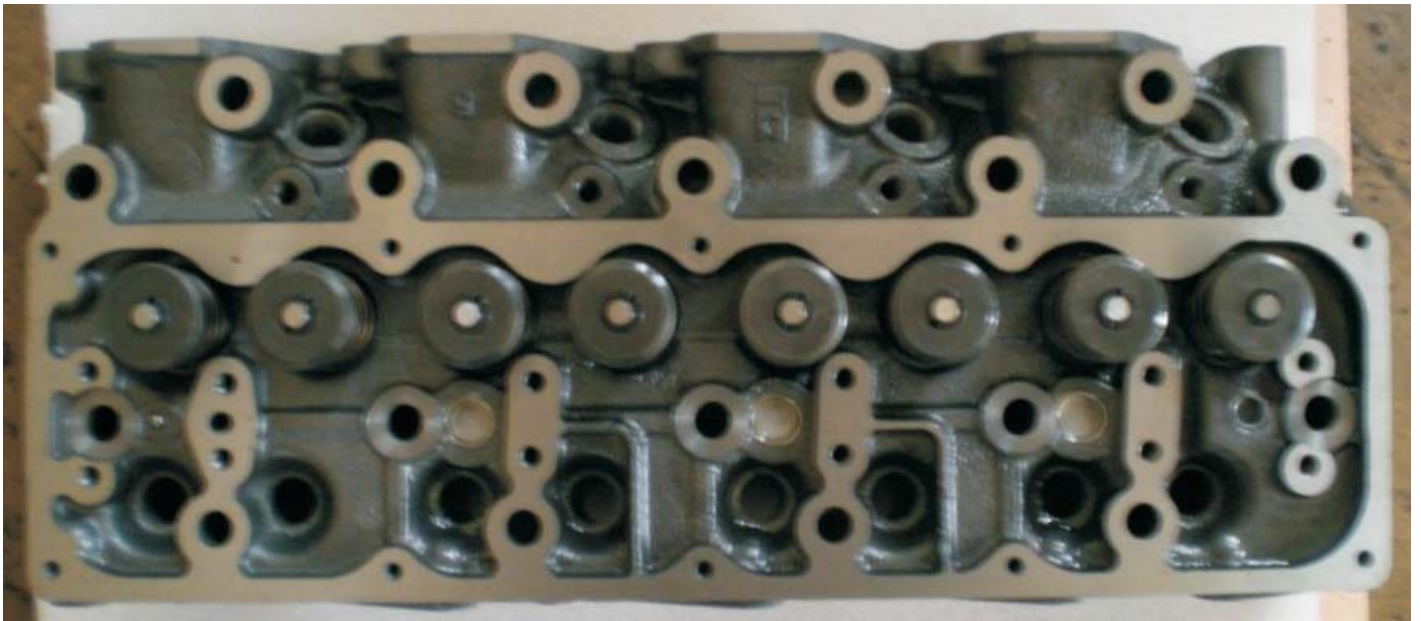

# CYLINDER HEAD ASSY

VW

ISO9001:2000/TS16949

AMC NO.	OEM NO.	ENGINE	VALVE/CM <sup>3</sup>	APPLICATION
908 501	9608434580 02.00.F2	XUD7	8 1.8L	405

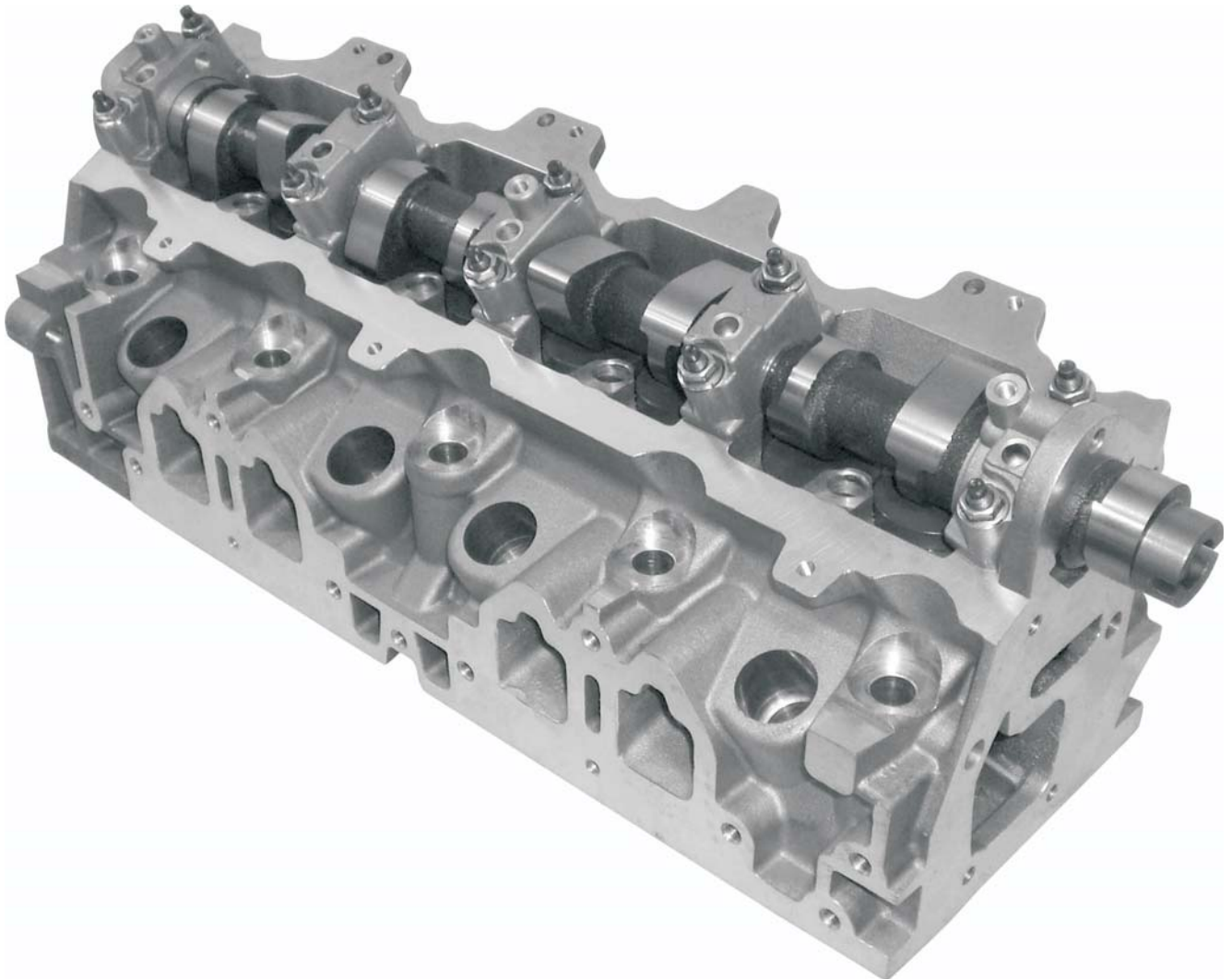

# CYLINDER HEAD ASSY

VW

ISO9001:2000/TS16949

AMC NO.	OEM NO.	ENGINE	VALVE/CM <sup>3</sup>	APPLICATION
908 067	02.00.J3	XUD9 A/L D9B	8 1.9 D 1905	306 405

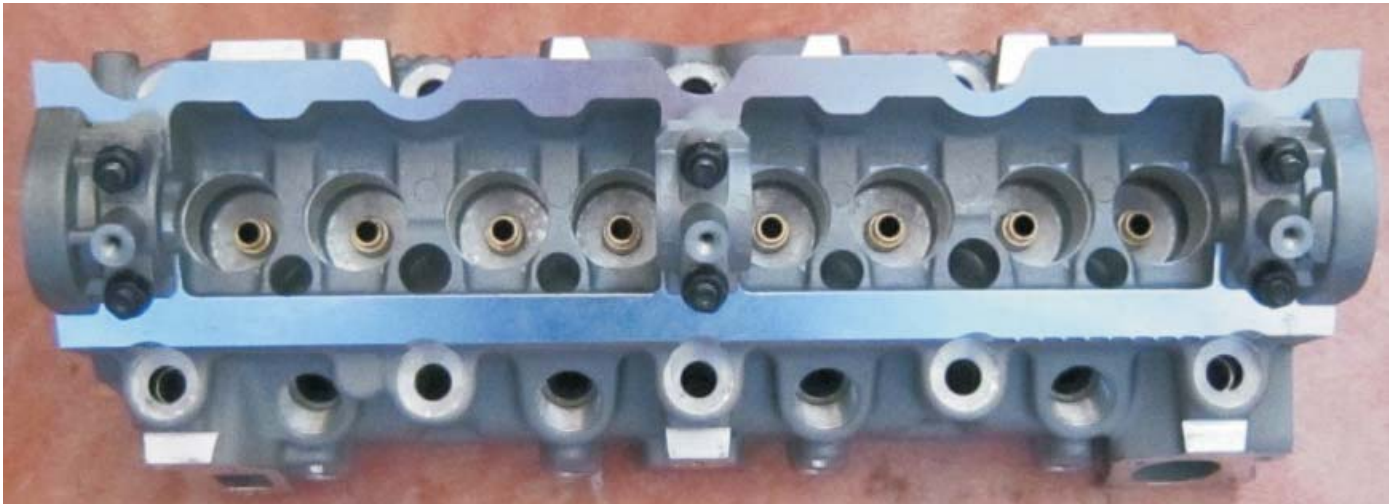

# CYLINDER HEAD ASSY

VW

ISO9001:2000/TS16949

AMC NO.	OEM NO.	ENGINE	VALVE/CM <sup>3</sup>	APPLICATION
908 501	9614838980	XUD10	8 2.0L	405

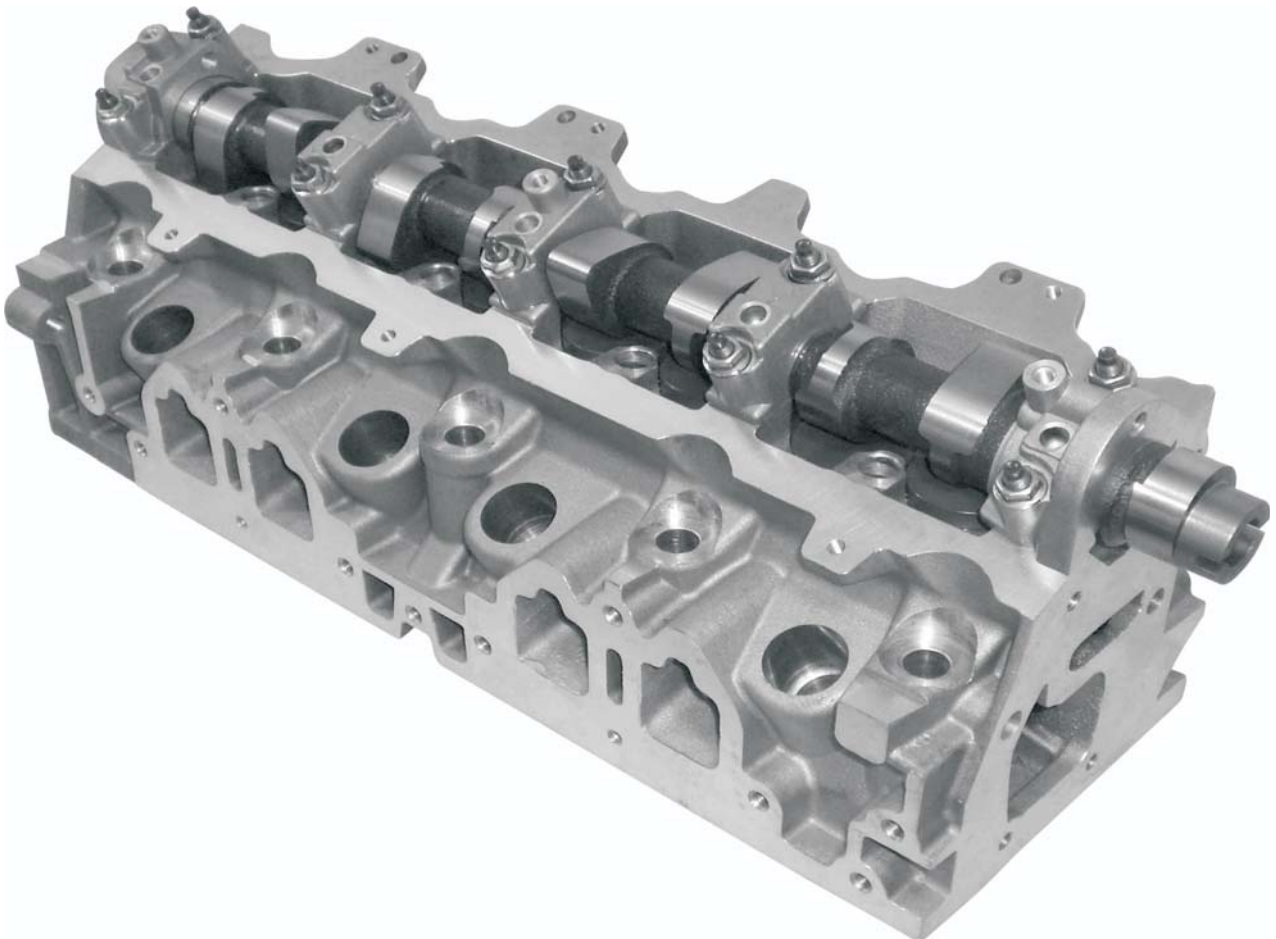

# CYLINDER HEAD ASSY

V W

ISO9001:2000/TS16949

AMC NO.	OEM NO.	ENGINE	VALVE/CM <sup>3</sup>	APPLICATION
908 537	9569145580 02.00.W3	DW8/DW8T DW8 B	8 1.8 D 1.9 D	206/306 parther Expert

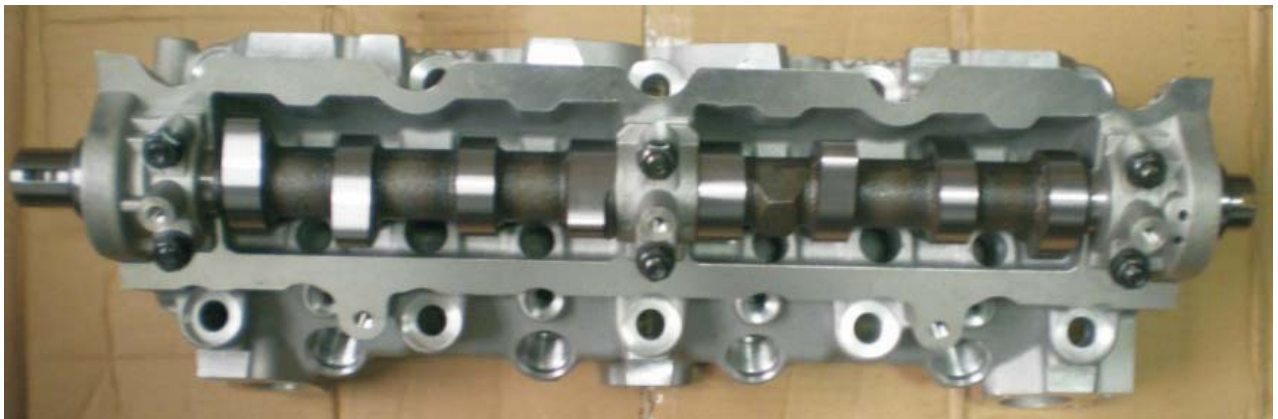

# CYLINDER HEAD ASSY

V W

ISO9001:2000/TS16949

AMC NO.	OEM NO.	ENGINE	VALVE/CM <sup>3</sup>	APPLICATION
	96642708		6	MATIZ

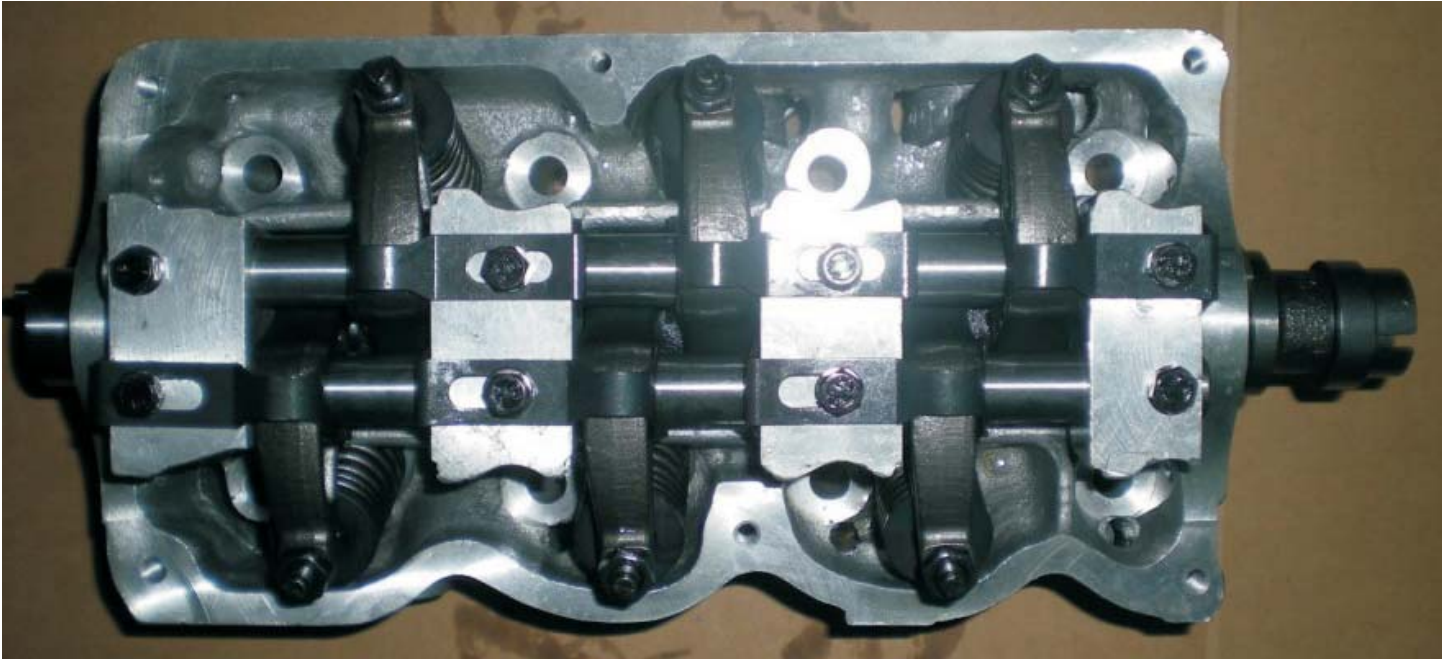

# CYLINDER HEAD ASSY

V W

ISO9001:2000/TS16949

AMC NO.	OEM NO.	ENGINE	VALVE/CM <sup>3</sup>	APPLICATION
	11110-78000-000		6	TICO

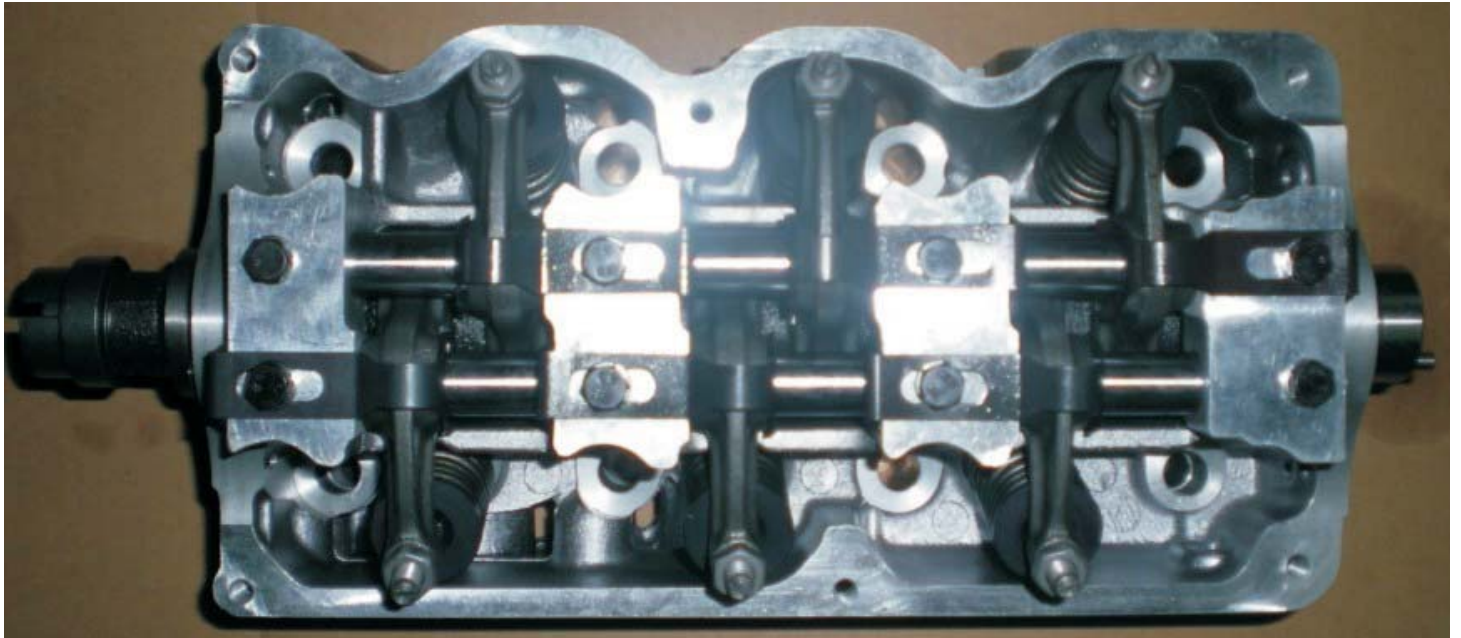



# CYLINDER HEAD ASSY

VW

ISO9001:2000/TS16949

AMC NO.	OEM NO.	ENGINE	VALVE/CM <sup>3</sup>	APPLICATION
908 512	22100-42900 22100-427A1	D4BA D4BAT DABB	8 2.5DT	H100/H1



# CYLINDER HEAD ASSY

VW

ISO9001:2000/TS16949

AMC NO.	OEM NO.	ENGINE	VALVE/CM <sup>3</sup>	APPLICATION
908 511	22100-42U00	4D56 4D55	8 2.3D 2.5D	H100/H1



# CYLINDER HEAD ASSY

VW

ISO9001:2000/TS16949

AMC NO.	OEM NO.	ENGINE	VALVE/CM <sup>3</sup>	APPLICATION
908 513	22100-42200 22100-42000 22000-42A20 22100-42960	D4BA D4BAT D4BH D4BX	8 2.5TD	H100/H1



# CYLINDER HEAD ASSY

VW

ISO9001:2000/TS16949

AMC NO.	OEM NO.	ENGINE	VALVE/CM <sup>3</sup>	APPLICATION
908 770	22100-42700	4D56 4D55	8 2.5D	H100/H1



# CYLINDER HEAD ASSY

V W

ISO9001:2000/TS16949

AMC NO.	OEM NO.	ENGINE	VALVE/CM <sup>3</sup>	APPLICATION
	3A7G-6C032-CA	L8 CAF488Q0	16 1.8	FOCUS

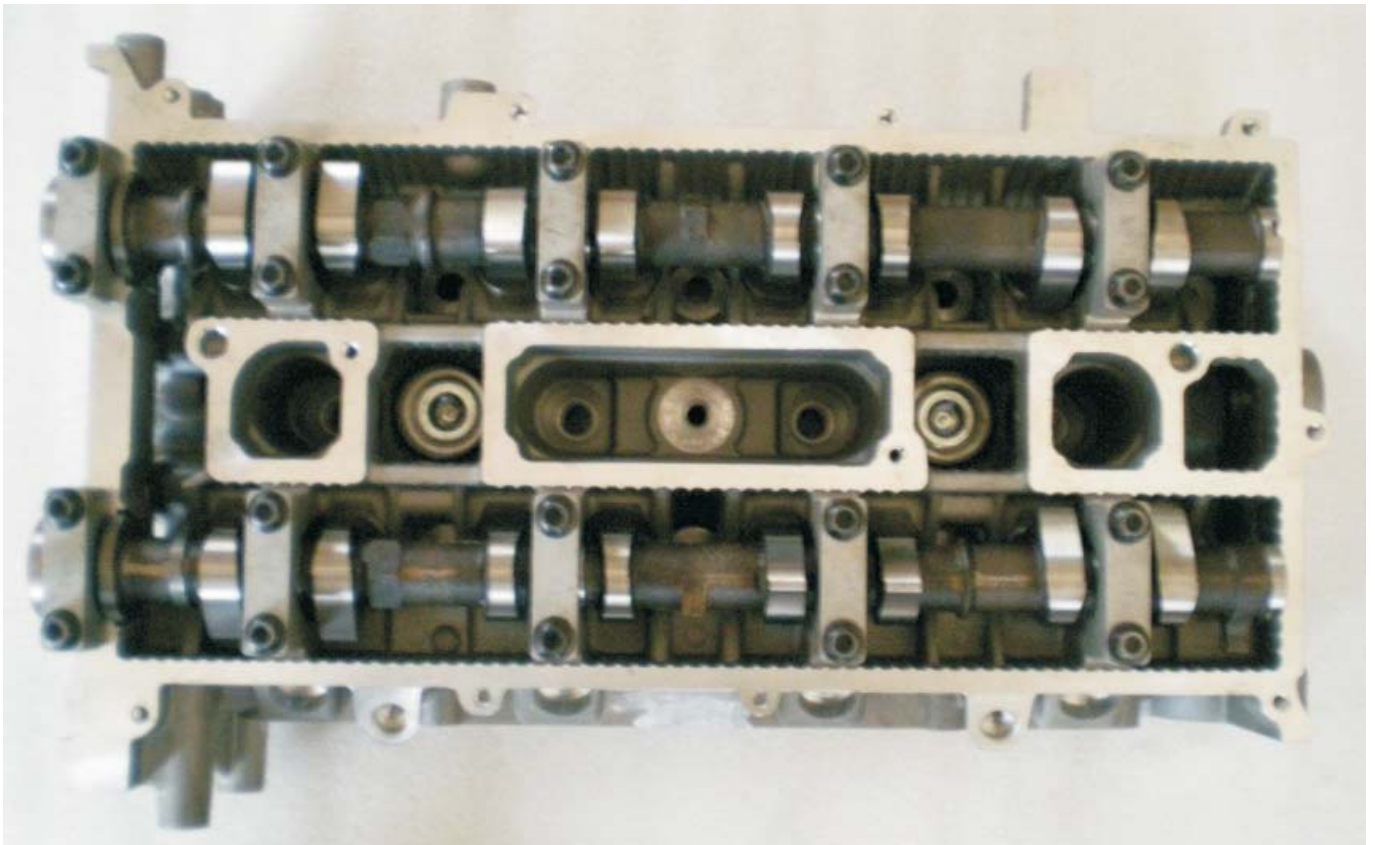

# CYLINDER HEAD ASSY

V W

ISO9001:2000/TS16949

AMC NO.	OEM NO.	ENGINE	VALVE/CM <sup>3</sup>	APPLICATION
		LF CAF488Q2 CAF488Q1	16 2.0	MONDEO FOCUS

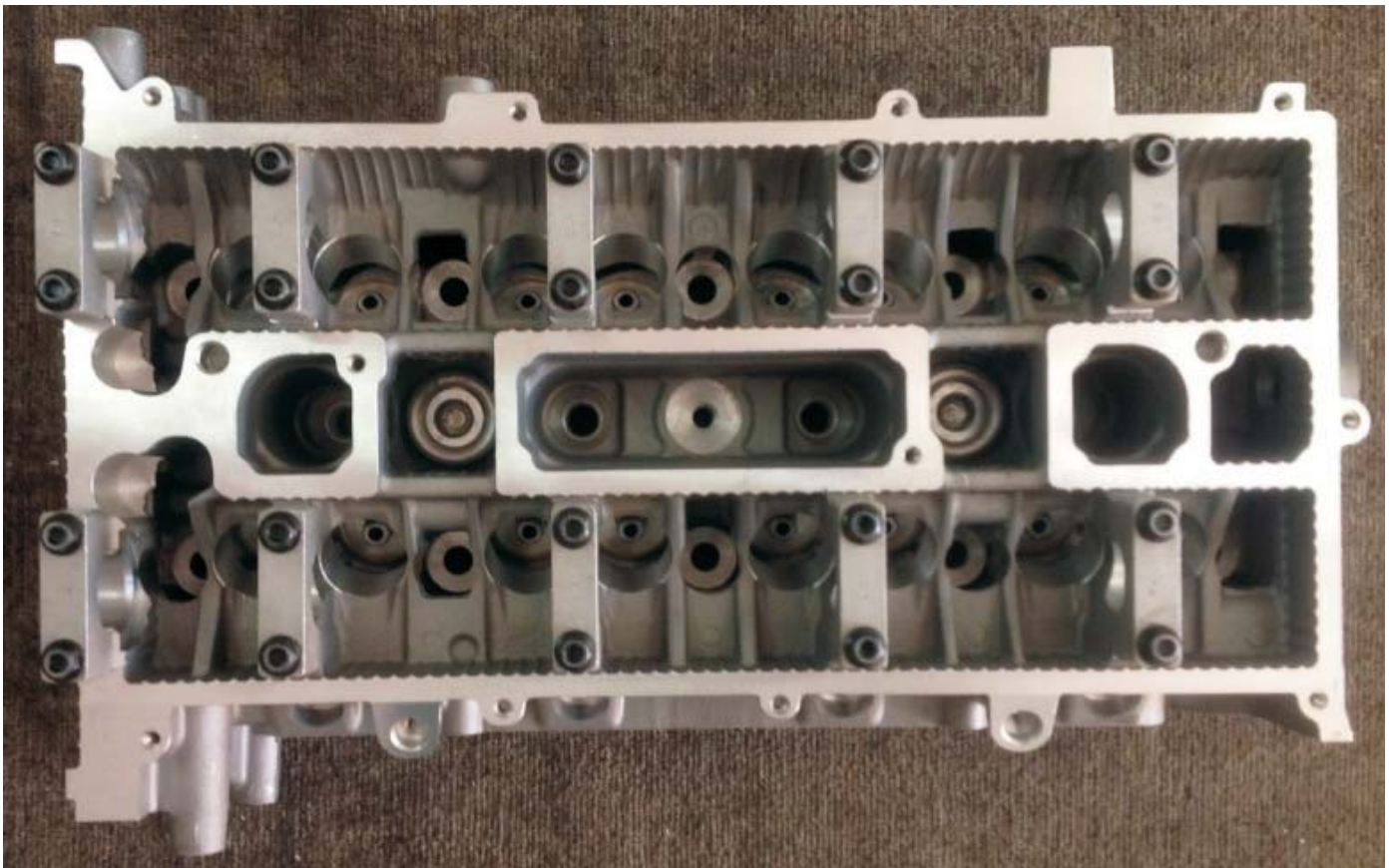

# CYLINDER HEAD ASSY

VW

ISO9001:2000/TS16949

AMC NO.	OEM NO.	ENGINE	VALVE/CM <sup>3</sup>	APPLICATION
	L30910090M	L3	16 2.3	MONDEO S-MAX



# CYLINDER HEAD ASSY

V W

ISO9001:2000/TS16949

AMC NO.	OEM NO.	ENGINE	VALVE/CM <sup>3</sup>	APPLICATION
	89708633824	4JG2	8	ISUZU





# CYLINDER HEAD ASSY

V W

ISO9001:2000/TS16949

AMC NO.	OEM NO.	ENGINE	VALVE/CM <sup>3</sup>	APPLICATION
	11110-80002	F10A	8 1.0	SUZUKI

