

**CAG-301** 10.9g



(12015987)REM.BLOCK TO THE RADIATOR ELECTROCONDUCTOR

**CAG-302** 13.6g



CONNECTOR 7-WAY 3CABLES FOR FREIGHTLINER

**CAG-303** 14.5g



5 WAY FUEL PUMP CONNECTOR PLUG FOR CHRYSLER 300C

**CAG-313** 6.2g



2 WAY FUEL INJECTOR IGNITION COIL WATER TEMPERATURE SENSOR CONNECTOR PLUG

**CAG-314** 15.5g



(13519912)REM.BLOCK TO THE MASS FLOW SENSOR (DMR) 21116 8 EVRO-4

**CAG-315** 8.5g



3 WAY 12059595 TRANSDUCER CONNECTOR PLUG FOR BYD MITSUBISHI

**CAG-304** 9.3g



2 WAY 15336117 FOG LAMP HARNESS PLUG FOR VOLKSWAGEN AUDI PASSAT

**CAG-305** 8.9g



2 WAY 829441-1 FUEL INJECTOR CONNECTOR PLUG FOR

**CAG-306** 8.5g



(15300027)PACKAGE TO THE HEATER ENGINE

**CAG-316** 8.7g



3 WAY 936060-1 TRANSDUCER CONNECTOR PLUG FOR BUICK ENCLAVE

**CAG-317** 19.6g



8 WAY 15326835 TRANSDUCER CONNECTOR PLUG FOR BUICK CHEVROLET EXCELLE GT GEELY

**CAG-318** 1.6g



(12065863) REM. NABOR-BOAT OF THE RESTRICTOR OF VENTIL, ENGINE COOLING, 1118, 2123 AND THEIR FASHION.

**CAG-307** 9.0g



(401820) REM. NABOR-CHOP TO THE D.C.P.D.S., DISRUPTED, HILL FOR THE GAZ

**CAG-308** 8.5g



(13510096)REM.BLOCK TO THE OIL PRESSURE SENSOR, COOLING LIQUID 1117-1119, 2170

**CAG-309** 10.5g



(1355668-2) REM. NAB-BOAT OF THE FOG LAMP TO LAMP H9

**CAG-319** 10g



(12162144)OXYGEN SENSOR CONNECTOR

**CAG-320** 7.7g



3 WAY 12059595 TRANSDUCER CONNECTOR PLUG FOR BYD MITSUBISHI

**CAG-321** 4.6g



2 WAY 15336024 WATER TEMPERATURE SENSOR CONNECTOR PLUG FOR BUICK REGAL LACROSSE

**CAG-310** 10.5g



(1-967412-2) RELAY OF THE RELAY OF GENERATOR 1117,1118,1119

**CAG-311** 7.5g



2 WAY 282189-1 FUEL INJECTOR IGNITION COIL WATER TEMPERATURE SENSOR CONNECTOR PLUG

**CAG-312** 8.5g



H1 NR-8K 863949-001

**CAG-322** 8.7g



4 WAY 12162279 IDLE MOTOR CONNECTOR PLUG FOR BYD FO F3 F6 S6 M6 G6 L3 G3

**CAG-323** 7.5g



3 WAY IGNITION COIL CONNECTOR PLUG FOR

**CAG-324** 10.5g



(12162859)REM.BLOCK TO THE IGNITION MODULE (OLD SAMPLE)

**CAG-325** 11.5g



(1928403198) REM.BLOCK TO THE OXYGEN SENSOR FOR GAZEL

**CAG-326** 11.8g



2 WAY 6-176146-6 FAN CONNECTOR PLUG FOR TOYOTA RAV4 BUICK EXCELLE

**CAG-327** 12.6g



2 WAY FAN CONNECTOR PLUG FOR TOYOTA RAV4 BUICK EXCELLE

**CAG-337** 5.0g



2 WAY 12052644 AIR CONDITIONER COMPRESSOR AIR PUMP CONNECTOR PLUG

**CAG-338** 5.0g



2 WAY 12052643 ELECTROMAGNETIC VALVE CONNECTOR PLUG FOR RED PALADIN

**CAG-339** 6.8g



2 WAY 1928403874 FUEL INJECTOR IGNITION COIL WATER TEMPERATURE SENSOR CONNECTOR PLUG

**CAG-328** 10.3g



4 WAY IGNITION COIL CONNECTOR PLUG FOR VOLVO S60 S70 S80 XC90

**CAG-329** 7.9g



4 WAY 12162189 15336035 IDLE MOTOR CONNECTOR PLUG FOR BYD FO F3 F6 S6 M6 G6 L3 G3

**CAG-330** 16.4g



6 PIN ELECTRONIC THROTTLE CONNECTOR PLUG

**CAG-340** 11.0g



1-967616-1 THROTTLE SENSOR CONNECTOR PLUG FOR BMW

**CAG-341** 6.4g



3 WAY FUEL INJECTOR IGNITION COIL WATER TEMPERATURE SENSOR CONNECTOR PLUG FOR HAVAL

**CAG-342** 6.59g



(15368586) REM.BLOCK OF SPEED SENSOR 1117,1118,1119

**CAG-331** 12.8g



(42121400) REM.BLOCK TO THE ABSOLUTE PRESSURE SENSOR AND TEMPERATURE FOR UMM ENGINES

**CAG-332** 17.5g



(12052480) REM.BLOCK DECK BURNS A VAZ 5 CONT

**CAG-333** 13.6g



(12052600) REM.BLOCK TO BURN THE WAZ, CHEVROLET NIVA, 5 CONTRIDGE

**CAG-343** 4.8g



2 WAY 12161194 FUEL INJECTOR IGNITION COIL WATER TEMPERATURE SENSOR CONNECTOR PLUG

**CAG-344** 4.5g



(12052644) AIR CONDITIONING COMPRESSOR AIR CONDITIONING PUMP PLUG

**CAG-345** 13.4g



(09441602) REM.NADOR-BOAT OF THE DANISH MASSES, THE SIEMENS OF SIEMENS (20.3855) FOR GAZ FROM VIGOUR.406

**CAG-334** 13g



(1928403813) REM.BLOCK TO THE MASS FLOW SENSOR

**CAG-335** 10.69g



(1928405159) BUICK YINGLANG NEW LACROSSE CRUZ AIR FLOWMETER PLUG

**CAG-336** 10.7g



THE HOLDER OF THE SAFETY DEVICE WITH THE UNIVAL CAP OF 1A TO 30A

**CAG-346** 9.0g



2 WAY 827551-3 FUEL INJECTOR IGNITION COIL WATER TEMPERATURE SENSOR CONNECTOR PLUG FOR HAVAL 4G64 CUV H3 H5

**CAG-347** 12.3g



2 WAY 12124819 HEADLIGHTS CONNECTOR PLUG FOR FORD TOYOTA H11 H8

**CAG-348** 23.5g



2112-1139080-01 FUEL PUMP (4WAY)

**CAG-349** 8.6g



(129140) REM.BLOCK FOR SUB-KNUCK 0280158502

**CAG-350** 8.7g



(1928403110) REM.BLOCK TO DUTCH.ABSOLATION, CUSHION AND MODULE BURNT

**CAG-351** 5.3g



12078090 15397275 THROTTLE SENSOR CONNECTOR PLUG

**CAG-361** 5.9g



2WAY

**CAG-362** 39.6g



**CAG-363** 10.1g



**CAG-352** 4.1g



(829572-1) REM.BLOCK TO SWITCHBOARD SWITCHES, DOOR, CONTROL

**CAG-353** 11.2g



(829572-1) SOCKET

**CAG-354** 1.9g



(52266-0211) REM.BLOCK TO THE PARKING SYSTEM SENSOR

**CAG-364** 2.8g



4WAY

**CAG-365** 4.5g



SWITCHING TO THE OXYGEN SENSOR

**CAG-366** 4.9g



(282103-1) CONN PLUG 1P 1.5 SERIES BLACK WITH WIRE

**CAG-355** 2.5g



(52213-0211) REM.BLOCK OF THE PARKING SYSTEM SENSOR

**CAG-356** 11.9g



SWITCH TO FOG LAMPS H8, H11, H27/2, FOR KALIN, PRIOR.

**CAG-357** 90g



FUEL PUMP CONNECTOR PLUG FOR FORD MONDEO WINS 2.0T

**CAG-367** 4.0g



(282079-2) CONN PLUG 1P 1.5 SERIES BLACK WITH WIRE

**CAG-368** 8.2g



(282104-1) CONN PLUG 2P 1.5 SERIES BLACK WITH WIRE

**CAG-369** 7.5g



(282080) CONN PLUG 2P 1.5 SERIES BLACK WITH WIRE

**CAG-358** 15g



(1928403202) REM.NAB-CHOP TO THE ELECTRONIC STALKING OF LADA, DAEWOO, CHEVROLET

**CAG-359** 18.5g



(1813345-1) REM. NABOR-BOAT TO BAY 2170, WITH WIRES

**CAG-360** 31.9g



4WAY

**CAG-370** 11.8g



(282105-1) CONN PLUG 3P 1.5 SERIES BLACK WITH WIRE

**CAG-371** 10.7g



(282087-1) CONN PLUG 3P 1.5 SERIES BLACK WITH WIRE

**CAG-372** 15.6g



(282106-1) CONN PLUG 4P 1.5 SERIES BLACK WITH WIRE



**CAG-373** 14.1g

(282088-1) CONN PLUG 4P 1.5 SERIES BLACK WITH WIRE

**CAG-374** 18.9g

(282107-1) CONN PLUG 5P 1.5 SERIES BLACK WITH WIRE

**CAG-375** 17.4g

(282089-1) CONN PLUG 5P 1.5 SERIES BLACK WITH WIRE

**CAG-385** 5.0g

GM OXYGEN SENSOR PIGTAIL USE WITH KEN OXYGEN SENSOR 138-101

**CAG-386** 6.5g

(12010996) MALE 1P

**CAG-387** 7.9g

GM TRANSMISSION CONVERTER CLUTCH CONNECTOR

**CAG-376** 22.5g

(282108) CONN PLUG 6P 1.5 SERIES BLACK WITH WIRE

**CAG-377** 20.9g

(282090) CONN PLUG 6P 1.5 SERIES BLACK WITH WIRE

**CAG-378** 8.0g

2 WAY 184002-1 TRANSDUCER CONNECTOR PLUG

**CAG-388** 10.9g

(12010973) MALE 2P

**CAG-389** 13.2g

(16137039) MANIFOLD ABSOLUTE PRESSURE (MAP) CONNECTOR PIGTAIL FITS GM MAP SENSOR ON GM VEHICLES

**CAG-390** 15.5g

(12010717) MALE 3P

**CAG-379** 10.0g

3 WAY PRESSURE SENSOR CONNECTOR PLUG FOR MITSUBISHI

**CAG-380** 9.8g

3 WAY MOTOR CONNECTOR PLUG FOR VOLVO

**CAG-381** 13.3g

4 WAY SENSOR CONNECTOR PLUG FOR NISSAN

**CAG-391** 17.5g

IDLE AIR CONTROL CONNECTOR PIGTAIL FITS GM IDLE AIR CONTROL MOTOR 2553222 ON BUICK

**CAG-392** 18.6g

(12015024) MALE 4P

**CAG-393** 18.4g

(1201579) GM IDLE SPEED CONTROL MOTOR PIGTAIL. USE WITH KEN IDLE SPEED CONTROL 150-112

**CAG-382** 18.2g

6 WAY SENSOR CONNECTOR PLUG FOR RENAULT

**CAG-383** 20.3g

8 WAY

**CAG-384** 22.2g

8 WAY

**CAG-394** 23.6g

(12020830) MALE 4P

**CAG-395** 29g

(12010799) FEMALE 6P

**CAG-396** 29g

(12010975) MALE 6P





**CAG-421** 6.2g



2WAY

**CAG-422** 19.2g



3WAY

**CAG-423** 6.5g



2 WAY FUEL INJECTOR CONNECTOR  
 PLUG FOR GEELY CHERY

**CAG-433** 45.5g



(967650) REM. NABOR-BOAT OF THE BAYONET IS  
 DIRECT FOR THE HEADLAMPS AND LAMPS OF THE KAMAZ,  
 MAZ, GAZA, (AIR 23.3775, 231.3775) WITH7

**CAG-434** 59g



**CAG-435** 3.7g



CONNECTOR PLUG 1P 6.3  
 SERIES WHITE WITH WIRE

**CAG-424** 16.3g



5 WAY 6189-0618 FUEL PUMP CONNECTOR  
 PLUG FOR TOYOTA CAMRY COROLLA REIZ

**CAG-425** 7.8g



2WAY

**CAG-426** 14.8g



(6098-0108)MODERN ELANT MOVING  
 SONATA SERATUR MAZDA 6  
 GENERATOR PLUG

**CAG-436** 3.4g



CONNECTOR PLUG 1P 6.3  
 SERIES WHITE WITH WIRE

**CAG-437** 6.4g



CONNECTOR PLUG 2P 6.3  
 SERIES WHITE WITH WIRE

**CAG-438** 7.8g



CONNECTOR PLUG 2P 6.3  
 SERIES WHITE WITH WIRE

**CAG-427** 6.4g



2WAY

**CAG-428** 21.5g



4WAY

**CAG-429** 21.5g



4WAY

**CAG-439** 10.7g



CONNECTOR PLUG 3P 6.3  
 SERIES WHITE WITH WIRE

**CAG-440** 11.5g



CONNECTOR PLUG 3P 6.3  
 SERIES WHITE WITH WIRE

**CAG-441** 14.0g



CONNECTOR PLUG 4P 6.3  
 SERIES WHITE WITH WIRE

**CAG-430** 7.4g



2WAY

**CAG-431** 23.1g



6 WAY FUEL PUMP CONNECTOR PLUG FOR  
 BUICK EXCELLE CHEVROLET LOVA  
 SPARK SPARK

**CAG-432** 21.8g



(1-967325-1) 2 WAY BRAKE PAD  
 CONDUCTOR (1845-3724580)

**CAG-442** 14.3g



CONNECTOR PLUG 4P 6.3  
 SERIES WHITE WITH WIRE

**CAG-443** 18.5g



CONNECTOR PLUG 6P 6.3  
 SERIES WHITE WITH WIRE

**CAG-444** 19.8g



CONNECTOR PLUG 6P 6.3  
 SERIES WHITE WITH WIRE

**CAG-445** 22.3g



CONNECTOR PLUG 8P 6.3 SERIES WHITE WITH WIRE

**CAG-446** 22.7g



CONNECTOR PLUG 8P 6.3 SERIES WHITE WITH WIRE

**CAG-447** 6.1g



2 WAY IGNITION COIL CONNECTOR PLUG FOR HYUNDAI ELANTRA CERATO

**CAG-457** 6.3g



2 WAY 6189-0033 WATER TEMPERATURE CONTROL CONNECTOR PLUG FOR

**CAG-458** 11.9g



3 WAY 13511996 PRESSURE SENSOR CONNECTOR PLUG

**CAG-459** 7.6g



2WAY

**CAG-448** 7.5g



2 PIN KETTLE MOTOR CONNECTOR PLUG FOR VOLVO XC60 S40 S60 S80 XC90 V40 V60

**CAG-449** 7.5g



2 PIN FUEL INJECTOR CONNECTOR PLUG FOR FORD MAZDA M6M3 PENTIUM B70

**CAG-450** 10.9g



4 WAY IGNITION COIL CONNECTOR PLUG FOR COROLLA LEXUS CAMRY REIZ TOYOTA

**CAG-460** 5.2g



1 WAY FUEL PUMP CONNECTOR PLUG FOR VOLKSWAGEN

**CAG-461** 4.7g



2 WAY FUEL PUMP CONNECTOR PLUG FOR VOLKSWAGEN A4L Q7

**CAG-462** 9.0g



4 WAY FUEL PUMP CONNECTOR PLUG FOR WEICHAI

**CAG-451** 14.6g



4 WAY 282192-1 IGNITION COIL CONNECTOR PLUG FOR VOLKSWAGEN PASSAT AUDI A6 C5

**CAG-452** 10.3g



3 WAY IGNITION COIL CONNECTOR PLUG FOR NISSAN

**CAG-453** 11.7g



4 WAY FUEL PUMP CONNECTOR PLUG FOR NISSAN

**CAG-463** 7.1g



2WAY

**CAG-464** 12.2g



3WAY

**CAG-465** 14.0g



4WAY

**CAG-454** 16.8g



6 WAY HEADLIGHTS CONNECTOR PLUG FOR LEXUS

**CAG-455** 13.9g



4 PIN FUEL PUMP CONNECTOR PLUG FOR HONDA ACCORD CRV

**CAG-456** 4.8g



2 WAY FUEL INJECTOR CONNECTOR PLUG FOR BUICK EXCELLE

**CAG-466** 20.2g



6 PIN FUEL PUMP CONNECTOR PLUG FOR LAND ROVER EVOQUE DISCOVERY 3 F REELANDER 2 JAGUAR XF XJ

**CAG-467** 15.5g



4WAY

**CAG-468** 12.3g



5WAY



**CAG-469** 14g



(1-1419168-1) REM.BLOCK TO THE EL-DROSSEL CONNECTOR OF THE ENGINE UMZ-4216 EURO4 AND 21127-1148010 WAZ

**CAG-470** 6.7g



2WAY

**CAG-471** 7.0g



2WAY

**CAG-201** 15.9g



9005 SOCKET CERAMIC

**CAG-202** 15.9g



9006 SOCKET CERAMIC

**CAG-203** 10.7g



9005 SOCKET PLASTIC

**CAG-472** 5.2g



1WAY

**CAG-473** 5.2g



(1-967644-1, 968405-1) REM.BLOCK TO DUTCH. TEMPER. OUTSIDE AIR, ABS, GRANTA.

**CAG-474** 8.9g



2WAY

**CAG-204** 10.7g



9006 SOCKET PLASTIC

**CAG-205** 15.5g



H8/H11 SOCKET CERAMIC

**CAG-206** 20.5g



H4 SOCKET CERAMIC

**CAG-475**



2WAY

**CAG-476** 9.9g



LOADING OF THE ELECTROBONE PUMP MODULE 1118 (3827040)

**CAG-477** 12.3g



LOADING OF THE ELECTROBONE PUMP MODULE 3122 (3827040)

**CAG-207** 20.5g



H4 SOCKET CERAMIC

**CAG-208** 20.5g



H4 SOCKET CERAMIC

**CAG-209** 12.5g



H4 SOCKET PLASTIC

**CAG-478** 14.5g



LOADING OF THE ELECTROBONE PUMP MODULE 21073 (3827040)

**CAG-479**



6WAY

**CAG-480** 83g



4WAY

**CAG-210** 28.5g



RELAY SOCKET CERAMIC

**CAG-211** 5.9g



H1/H3 SOCKET CERAMIC

**CAG-212** 13.6g



H7 SOCKET CERAMIC

CERAMIC PLUG AND FUSE HOLDER FOR HEADLAMP

CAG-213 12.8g



H7 SOCKET CERAMIC

CAG-214 23.2g



H4 HEAD LIGHT SOCKET W/RUBBER  
HIGH HEAT RATING

CAG-215 29.0g



9004/9007 SOCKET CERAMIC

CAG-216 19.3g



9004/9007 SOCKET PLASTIC

CAG-217 6.2g



H1 SOCKET CERAMIC

CAG-218 6.9g



BA15S SOCKET NICKEL-CLAD IRON

CAG-219 7.2g



BA15D SOCKET NICKEL-CLAD IRON

CAG-220 5.9g



BA9S SOCKET NICKEL-CLAD IRON

CAG-221 5.8g



T10 SOCKET RUBBER

CAG-222 2.8g



T5 SOCKET PLASTIC

CAG-223 3.8g



T10 SOCKET PLASTIC

CAG-224 4.5g



T10 SOCKET RUBBER

CERAMIC PLUG AND FUSE HOLDER FOR HEADLAMP

CAG-225 14.5g



T20 SINGLE SOCKET PLASTIC

CAG-226 15.5g



T20 DOUBLE SOCKET PLASTIC

CAG-227

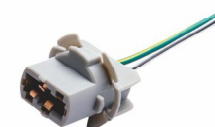

T20 SINGLE SOCKET PLASTIC

CAG-228 12g



BAY15D SOCKET PLASTIC NEW

CAG-229 11g



BAY15S SOCKET PLASTIC NEW

CAG-230 13.7g



BAY15S SOCKET PLASTIC OLD

CAG-231 14.8g



H4 SOCKET CERAMIC

CAG-232 7.3g



H7 SOCKET CERAMIC

CAG-233 16.5g



RELAY SOCKET PLASTIC

CAG-234 26.8g



RELAY SOCKET PLASTIC

CAG-235 12.5g









H4 SOCKET CERAMIC

CAG-236 17.1g





RELAY SOCKET PLASTIC























CERAMIC PLUG AND FUSE HOLDER FOR HEADLAMP

<p><b>CAG-237</b> 4.6g</p>  <p>SOCKET PLASTIC</p>	<p><b>CAG-238</b> 15.5g</p>  <p>FUSE SOCKET PLASTIC</p>	<p><b>CAG-239</b> 10.8g</p>  <p>FUSE SOCKET PLASTIC</p>
<p><b>CAG-240</b> 15.0g</p>  <p>FUSE SOCKET CERAMIC</p>	<p><b>CAG-241</b> 11.8g</p>  <p>FUSE SOCKET PLASTIC</p>	<p><b>CAG-242</b> 12.5g</p>  <p>STANDARD FUSE SOCKET RUBBER</p>
<p><b>CAG-243</b> 20.5g</p>  <p>FUSE SOCKET PLASTIC</p>	<p><b>CAG-244</b> 20.7g</p>  <p>STANDARD FUSE SOCKET RUBBER</p>	<p><b>CAG-245</b> 20.7g</p>  <p>STANDARD FUSE SOCKET RUBBER</p>
<p><b>CAG-246</b> 20.5g</p>  <p>STANDARD FUSE SOCKET RUBBER</p>	<p><b>CAG-247</b> 18.5g</p>  <p>MINI FUSE SOCKET RUBBER</p>	<p><b>CAG-248</b> 18.5g</p>  <p>STANDARD FUSE SOCKET RUBBER</p>

CERAMIC PLUG AND FUSE HOLDER FOR HEADLAMP

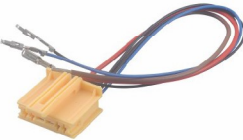
<p><b>CAG-249</b></p>  <p>CIRCUIT FUSE HOLDER FOR MINI TYPE FUSE 16GA</p>	<p><b>CAG-250</b></p>  <p>CIRCUIT FUSE HOLDER FOR STANDARD TYPE FUSE 16GA</p>	<p><b>CAG-251</b></p>  <p>BIG INSERT FUSE SOCKET PLASTIC</p>
<p><b>CAG-252</b></p>	<p><b>CAG-253</b></p>	<p><b>CAG-254</b></p>
<p><b>CAG-255</b></p>	<p><b>CAG-256</b></p>	<p><b>CAG-257</b></p>
<p><b>CAG-258</b></p>	<p><b>CAG-259</b></p>	<p><b>CAG-260</b></p>



<p><b>CAG-101</b></p>  <p>38MM BIG PIN FUEL PUMP CONNECTOR PLUG</p>	<p><b>CAG-102</b></p>  <p>38MM SMALL PIN FUEL PUMP CONNECTOR PLUG</p>	<p><b>CAG-103</b></p>  <p>2WAY</p>	<p><b>CAG-113</b></p>  <p>2WAY</p>	<p><b>CAG-114</b></p>  <p>4WAY</p>	<p><b>CAG-115</b></p> 
<p><b>CAG-104</b></p>  <p>368538-1 TWO PIN FUEL PUMP CONNECTOR PLUG FOR FORD FOCUS FIESTA</p>	<p><b>CAG-105</b></p>  <p>368538-1 TWO PIN FUEL PUMP CONNECTOR PLUG FOR FORD FOCUS FIESTA</p>	<p><b>CAG-106</b></p>  <p>2WAY</p>	<p><b>CAG-116</b></p>  <p>2 WAY FRONT WHEEL ANTI LOCK BRAKING SYSTEM CONNECTOR PLUG FOR VOLKSWAGEN SANTANA 2000 JETTA BORA</p>	<p><b>CAG-117</b></p>  <p>2WAY</p>	<p><b>CAG-118</b></p>  <p>2WAY</p>
<p><b>CAG-107</b></p>  <p>2WAY</p>	<p><b>CAG-108</b></p>  <p>2WAY</p>	<p><b>CAG-109</b></p>  <p>6 WAY FUEL PUMP CONNECTOR PLUG FOR BUICK FIRSTLAND REGAL LACROSSE</p>	<p><b>CAG-119</b></p>  <p>4WAY</p>	<p><b>CAG-120</b></p>  <p>2 WAY FUEL PUMP CONNECTOR PLUG FOR MAZDA CX-5</p>	<p><b>CAG-121</b></p>  <p>6 WAY FUEL PUMP CONNECTOR PLUG FOR CHEVROLET EPICA SPARK SPARK LOVA BUICK EXCELLE</p>
<p><b>CAG-110</b></p>  <p>4WAY</p>	<p><b>CAG-111</b></p>  <p>6WAY</p>	<p><b>CAG-112</b></p>  <p>69117 SIX WAY FUEL PUMP CONNECTOR PLUG FOR FORD LAND ROVER VOLVO</p>	<p><b>CAG-122</b></p>  <p>4WAY</p>	<p><b>CAG-123</b></p>  <p>69117 TWO WAY FUEL PUMP CONNECTOR PLUG FOR FORD LAND ROVER VOLVO</p>	<p><b>CAG-124</b></p>  <p>38MM BIG PIN FUEL PUMP CONNECTOR PLUG</p>

**CAG-125**



2WAY

**CAG-126**



2 WAY FUEL PUMP CONNECTOR PLUG FOR HONDA MITSUBISHI MAZDA TOYOTA

**CAG-127**



2 WAY FUEL PUMP CONNECTOR PLUG FOR CEFIRO A32

**CAG-137**



1WAY

**CAG-138**



2WAY

**CAG-139**



2 WAY FUEL PUMP CONNECTOR PLUG FOR TOYOTA REIZ

**CAG-128**



5WAY

**CAG-129**



4 WAY 68061344AA IGNITION COIL CONNECTOR PLUG

**CAG-130**



2 WAY FUEL PUMP CONNECTOR PLUG FOR JMC

**CAG-140**



2WAY

**CAG-141**



4WAY

**CAG-142**



2WAY

**CAG-131**



2 WAY FUEL PUMP CONNECTOR PLUG

**CAG-132**



2WAY

**CAG-133**



2 WAY FUEL PUMP CONNECTOR PLUG FOR MAZDA 6/M6 SEDAN PENTIUM B70B50

**CAG-143**



2WAY

**CAG-144**



2WAY

**CAG-145**



2WAY

**CAG-134**



2 WAY FUEL PUMP CONNECTOR PLUG FOR SYLPHY CEFIRO A32 A33

**CAG-135**



2 WAY FUEL PUMP CONNECTOR PLUG FOR MITSUBISHI OUTLANDER SOUEAST MOTOR FREECA

**CAG-136**



1WAY

**CAG-146**



38MM BIG PIN FUEL PUMP CONNECTOR PLUG

**CAG-147**



(12052641)WASHER PUMP PIGTAIL GM12102747

**CAG-148**



3WAY

**CAG-149**



2WAY

**CAG-150**



2 WAY FUEL PUMP CONNECTOR PLUG FOR HONDA 7TH ACCORD 7TH 2003-2007

**CAG-151**



2 WAY FUEL PUMP CONNECTOR PLUG FOR HONDA ACCORD ODYSSEY CRV

**CAG-161**



4WAY WULING 6376NF FUEL PUMP ASSEMBLY 6388 GASOLINE PUMP ASSEMBLY FOUR INSERT IRON BRACKET

**CAG-162**



4WAY WULING 6376NF FUEL PUMP ASSEMBLY 6388 GASOLINE PUMP ASSEMBLY FOUR INSERT IRON BRACKET

**CAG-163**



4WAY

**CAG-152**



4WAY

**CAG-153**



2 WAY FUEL PUMP CONNECTOR PLUG FOR TOYOTA REIZ

**CAG-154**



2 WAY FUEL PUMP CONNECTOR PLUG FOR TOYOTA REIZ

**CAG-164**



4 WAY FUEL PUMP CONNECTOR PLUG FOR JAC REFINE

**CAG-165**



4 WAY FUEL PUMP CONNECTOR PLUG FOR MAZDA M6 PENTIUM 670B50B90X80

**CAG-166**



2WAY

**CAG-155**



2WAY

**CAG-156**



2WAY

**CAG-157**



2WAY

**CAG-166**



4WAY

**CAG-167**



4WAY

**CAG-168**



2WAY

**CAG-158**



4WAY

**CAG-159**



4WAY

**CAG-160**



4WAY WULING 6376NF FUEL PUMP ASSEMBLY 6388 GASOLINE PUMP ASSEMBLY FOUR INSERT IRON BRACKET

**CAG-169**



FUEL PUMP CONNECTOR PLUG FOR BYD F3 F6 FAW JIABAO CHERY TIGGO

**CAG-170**



**CAG-171**





Kabelbaumstecker FEMALE CONNECTOR  
 3-polig 3-WAY  
 Schieber links SLIDER LEFT  
 Schieber offen SLIDER OPEN  
 Sekundärverriegelung offen SECONDARY LOCK OPEN

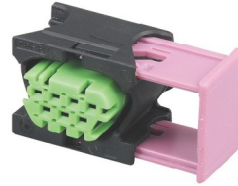

Kabelbaumstecker FEMALE CONNECTOR  
 6-polig 6-WAY  
 Schieber links SLIDER LEFT  
 Schieber offen SLIDER OPEN  
 Sekundärverriegelung offen SECONDARY LOCK OPEN

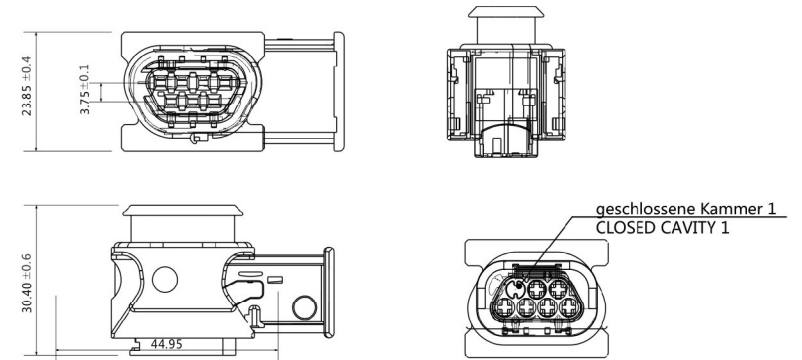
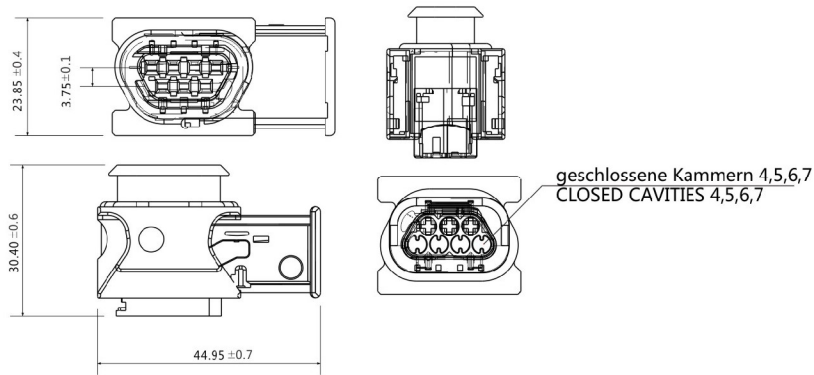

	Farbe der Sekundärverriegelung / COLOUR OF SECONDARY LOCK	Kodierung / CODE	Bestell Nr. / ORDER NO.
<p>CODE A6</p>	Grün / GREEN	CODE A6	
	Gelb / YELLOW	CODE B6	1 928 405 372
	Braun / BROWN	CODE C6	
	Natur / NATURAL	CODE C6	
<p>CODE B6</p>	<p>CODE C6</p>	<p>CODE D6</p>	

	Farbe der Sekundärverriegelung / COLOUR OF SECONDARY LOCK	Kodierung / CODE	Bestell Nr. / ORDER NO.
<p>CODE A6</p>	Grün / GREEN	CODE A6	1 928 405 374
	Gelb / YELLOW	CODE B6	
	Braun / BROWN	CODE C6	
	Natur / NATURAL	CODE C6	
<p>CODE B6</p>	<p>CODE C6</p>	<p>CODE D6</p>	

Kabelbaumstecker FEMALE CONNECTOR  
 7-polig 7-WAY  
 Schieber links SLIDER LEFT  
 Schieber offen SLIDER OPEN  
 Sekundärverriegelung offen SECONDARY LOCK OPEN

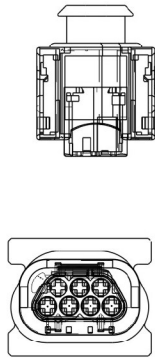
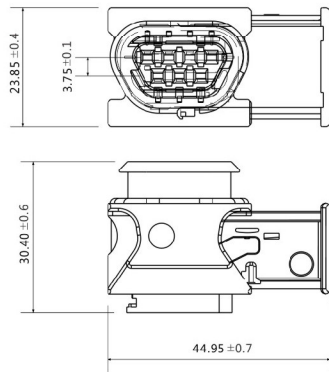
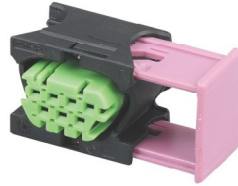

	Farbe der Sekundärverriegelung / COLOUR OF SECONDARY LOCK	Kodierung / CODE	Bestell Nr. / ORDER NO.
<p>CODE A7</p>	Lila / LILAC	CODE A7	1 928 405 388
	Blau / BLUE	CODE B7	
	Rot / RED	CODE C7	
	Grau / GREY	CODE D7	
<p>CODE B7</p>			
<p>CODE C7</p>			
<p>CODE D7</p>			



JST SERIES



SENSOR SERIES



PLUG-IN SERIES



DT SERIES

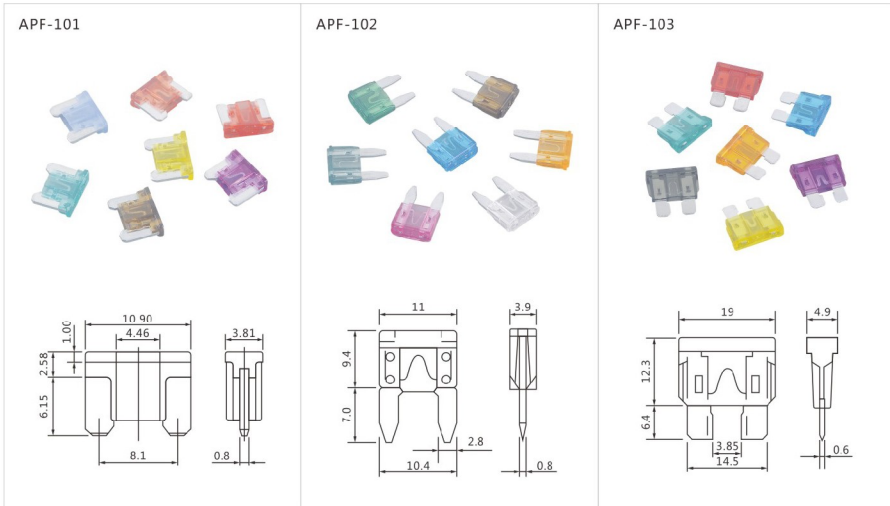

Fast Acting  
 Voltage Rating: DC32V or less  
 Interrupting Rating: 1000A@32VDC  
 Operating temperature Range: -40°C~ +125°C  
 Complies with SAE J2077/JASO D612/ISO 8820-3  
 Materials: 1. Zinc Alloy  
 2. Plastic  
 Characteristics of fuses according to use conditions may change.

Electrical characteristics		Rating		
Rating	Blowing Time	Ampere Rating	Voltage Rating	Color
110%	> 100 (hours time)	1	32	ondine
		2	32	grey
		3	32	violet
135%	0.75~1800 (s)	4	32	pink
		5	32	orange
		7.5	32	brown
200%	0.15~5 (s)	10	32	red
		15	32	blue
350%	0.04~0.5 (s)	20	32	yellow
		25	32	clear
		30	32	green
600%	0.02~0.1 (s)	35	32	purple
		40	32	dark orange

Fast Acting  
 Voltage Rating: DC32V or less  
 Interrupting Rating: 1000A@32VDC  
 Operating temperature Range: -40°C~ +125°C  
 Complies with SAE J2077/JASO D612/ISO 8820-3  
 Materials: 1. Zinc Alloy  
 2. Plastic  
 Characteristics of fuses according to use conditions may change.

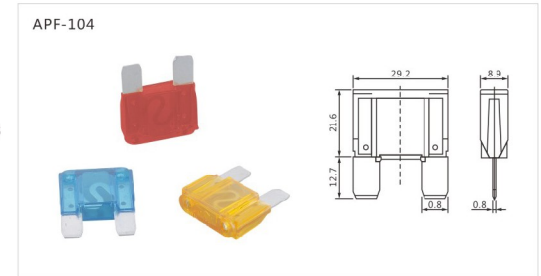

Electrical characteristics	
Rating	Blowing Time
110%	> 100 (hours time)
135%	60~1800(s)
200%	2~60 (s)
350%	0.2~7 (s)
600%	0.1~1 (s)

Rating		
Ampere Rating	Voltage Rating	Color
20A	32	yellow
30A	32	green
40A	32	pink
50A	32	red
60A	32	blue
70A	32	brown
80A	32	clear
10A	32	purple

EAST EUROPE FUSES

Fast Acting  
 Voltage Rating: DC32V or less  
 Materials: 1. Zinc Alloy (or Copper)  
 2. PBT (or Ceramic)  
 Size: 6×25mm



Electrical characteristics	
Rating	Blowing Time
150%	≥ 1 hours
250%	≤ 60s

Rating		
Ampere Rating	Voltage Rating	Color
5	32	orange
8	32	white
16	32	red
20	32	yellow
25	32	blue
30	32	green





Slow-Blow  
 Voltage Rating: DC32V or less  
 Interrupting Rating: 1000A @ 32VDC  
 Operating Temperature Range: -40°C~+125°C  
 Complies with JASO D612 / ISO 8820-4  
 Materials: 1. Brass 2. PC 3. Ceramic

Test Current	Opening Time	
	Min.	Max.
110%	4hrs	-
200%	5s	100s
350%	0.2s	7s
600%	0.04s	1s

额定值 Rating			颜色标准 Color
额定电流 Ampere Rating	额定电压 Voltage Rating		
20	32		badybiue
30	32		pink
40	32		green
50	32		red
60	32		yellow
70	32		brown
80	32		black
100	32		blue
120	32		white

