





101	OEM	Specification
	<p>VDO: AT- 08187R SIMENCE: C95166 OPEL: 826550,826548,817256 17113196 ,17111946 17108187 HOT- STAMP: 08187 GM:17108187 ,93214071 CHEVROLET: 17111823 DELPHI: ICD00124 HELLA: 6NW009141141 OEM: 17087259, 17087260 17089087, 17089088 WALKER: 215-1013 ACDELCO Part : 217412 STANDARD: AC7 17076277 817640</p>	<p>BUICK SKYLARK(88-89) OLDSMOBILE CALAIS (88-89) CUTLASS CALAIS (88-89) PONTIAC GRAND AM (88-89) SUNBIRD (92-94) VAUXHALL ASTRA MK III ESTATE 1.6 (91-94) MK III ESTATE 1.4 (91-98) NOVA HB 1.6L (88-92) HB 1.4 (91-93) HB CAT 1.6 (92-93) OPEL CORSA A HB 1.6 (88-92) A HB 1.4 (91-93) A HB CAT 1.6 (92-93) ASTRA F HB 1.6(92-94) F ESTATE 1.6 (92-94)</p>

102	OEM	Specification
	<p>SHORT CODE: 59600 DELPHI: ICD 00126 GM: 17059600 VDO: AT-59600R C0273 92026922 93214071 A95163</p>	<p>DAEWOO ESPERO 2.0 SOHC OPEL BLAZER 2.2L(95-96) 2.5L, L4(96) 4.3L(91)/(94-96) L4(92-93) KADETT 1.8L(91-95) 2.0L (91-96) MONZA 1.8L, L4 (91-96) 2.0L , L4(91-96) 1.6L, L4 (91-96) S10 2.0L, L4 (95-96) 2.5L, L4 (95-96) 2.8L , L4(96) 4.3L (96)</p>



103	OEM	Specification
	<p>SHORT CODE: 59602 DELPHI: ICD00120 GM: 17059602 VDO: AT-59602R 93744675 17111947 96434613 34613</p>	<p>CHEVROLET AVEO (04-06) DAEWOO LANOS SALOON (KLAT) 1.4,1.5,1.6(97) HB (KLAT) 1.4,1.5,1.6(97) NUBIRA HB (KLAJ) 1.6,2.0(97) SALOON (KLAJ) 1.6,2.0(97)</p>

104	OEM	Specification
	<p>SHORT CODE: 59603 DELPHI: ICD00125 GM: 17059603 OPEL: 817253, 817255 17112031, 17112023 SIMENCE: A95214 VDO: AT-59603R</p>	<p>OPEL CORSA A HB 1.4I(85-93) KADETT D HB 1.6I (79-84) D SALOON 1.6I (79-84) D ESTATE 1.6 I(79-84) E ESTATE 1.8I(85-91) E BOX 1.8I(84-92) E HB 1.8I (85-91) E SALOON 1.6I (86-91) E CAT SALOON 1.6 I (86-91) VAUXHALL CAVALIER MK II SALOON 1.6I (86-88) CHEVROLET ASTRO (92) S10 BLAZER (92) S10 PICKUP (92) GMC S15 JIMMY (92) S15 PICKUP (92) SAFARI(92) OLDSMOBILE BRAVADA (92)</p>



105	OEM	Specification
	<p>WELLS: AC132 GM: 17112898 WALKER: 215-1027 STANDARD: AC64 217426 8171128980 DELPHI:CV100125</p>	<p>BUICK CENTURY (93-96) CHEVROLET BERETTA(93-96) CAVALIER(93-97) CORSICA (93-96) LLV(94-95) S10 (94-97) GMC SONOMA (94-97) ISUZU HOMBRE (96-97) OLDSMOBILE CUTLASS CIERA (93-96) PONTIAC SUNFIRE (95-97)</p>
106	OEM	Specification
	<p>WELLS: AC104 STANDARD: AC11 GM:17111823 217413 17112131 17112132</p>	<p>BUICK SKYHAWK (87-88) CHEVROLET BERETTA(92) CAVALIER(92) CORSICA (92) GEO SPECTRUM (89) OLDSMOBILE FIRENZA(87-88) PONTIAC LEMANS (89-90) SUNBIRD (87-88)</p>
107	OEM	Specification
	<p>WELLS: AC166 OEM: 92061898 4030011</p>	<p>DAEWOO ESPERO 1.8L LEGANZAL4 2.2L(99-02) NUBIRA L4 2.0L(99-02) OPEL 1.8L 2.0L</p>



108	OEM	Specification
	<p>ATUADOR94700309</p>	
109	OEM	Specification
	<p>STANDARD:</p>	
110	OEM	Specification
	<p>WELLS: AC106 ,AC15 OEM: 17111826 , 17112031 17111827 MARELLI: 2300160790X7 DELCO: 217-411 WALKER: 215-1007 HELLA: 6NW009141131 ISUZU: 8-17111826-0</p>	<p>BUICK CENTURY (87-92) SKYLARK(87-93) CHEVROLET ASTRO (87-93) GEO STORM (90-93) GMC S15 (87-90) ISUZU IMPULSE(90-92) OLDSMOBILE ACHIEVA(92-93) PONTIAC GRAND AM (87-93)</p>



111	OEM	Specification
	PEUGEOT: 1920.W6 HELLA: 6NW 009 141-441 MAGNETI MARELLI: 230016079077 MAGNETI MARELLI:B14/00 MEAT & DORIA: 84014 SIEMENS VDO: C95185	CITROEN AX (ZA-_)HB (87-97) ZX (N2) ESTATE 1.4L (93-97) ZX (N2) HB 1.4L (91-97) PEUGEOT 306 HB (7A, 7C, N3, N5) 1.4L (93-01) 306 SEDAN (7B, N3, N5) SALOON 1.4L (94-01) 306 WG (7E, N3, N5) ESTATE 1.4L (97-02)
112	OEM	Specification
	SHORT CODE: D5177 RENAULT: 7701206370 VDO:AT-05177R SIMENCE:D95177	RENAULT 19 II HB (B/C535)1.4L(92-95) 19 Mk II HB (B/C535)1.4L(92-95) 19 Mk II Saloon (L535)1.4L(93-95) 19 II Chamade Saloon(L535)1.4L(93-95) CLIO I HB (B/C57T, B/C57Y) 1.4L (91-98) EXPRESS Box (G40_,F40U, F40V) 1.4L (91-98) EXTRA Van Box (G40_,F40U, F40V) 1.4L (91-98) RAPID Box (G40_,F40D) 1.4L (94-98) RAPID Box (G40_,40U, F40V) 1.4L (91-98)
113	OEM	Specification
	VDO:D95174, D5174 RENAULT:7701047909 7701042784	KIA PRIDE PAYKAN RENAULT CLIO MK II HB 1.6(98-05) MEGANE I (BA0F, BA0S) 1.6 E HB(96-99) I (BA0L)1.6 I HB (96-99) I BREAK (KA0F)ESTATE1.6 E(99) I CABRIOLET CONVERTIBLE1.6E(96-99) I CLASSIC CONVERTIBLE1.6E(96-99) I CLASSIC SALOON1.6E(96-99) I CLASSIC SALOON1.6I(96-99) I COUPE 1.6 E (96-99) SCENIC MPV 1.6 E(97-99) SCENIC MPV 1.6 I(97-99)



114	OEM	Specification
	VDO:D95174, D5174 RENAULT:7701047909 7701042784	KIA PRIDE PAYKAN RENAULT CLIO MK II HB 1.6(98-05) MEGANE I (BA0F, BA0S) 1.6 E HB(96-99) I (BA0L)1.6 I HB (96-99) I BREAK (KA0F)ESTATE1.6 E(99) I CABRIOLET CONVERTIBLE1.6E(96-99) I CLASSIC CONVERTIBLE1.6E(96-99) I CLASSIC SALOON1.6E(96-99) I CLASSIC SALOON1.6I(96-99) I COUPE 1.6 E (96-99) SCENIC MPV 1.6 E(97-99) SCENIC MPV 1.6 I(97-99)
115	OEM	Specification
	SHORT CODE D5134 VDO:D95134 RENAULT:7701044401	RENAULT CLIO I HB 1.4 (91-98) II HB 1.4 (98-05) MK II HB 1.4(98-05) KANGOO (KC0/1_) MPV 1.4 (97) EXPRESS (FC0/1_)BOX1.4(97) RAPID (FC0/1_) BOX1.4(97) MEGANE I (BA0/1_) HB 1.4 E (96) GRANDTOUR(KA0V)1.4 E ESTATE(99) WG (KA0V) ESTATE 1.4 E (99)
116	OEM	Specification
	VDO:C5105, C95105 AUDI:078133455	AUDI A4 (8D2, B5) ; COUPLE (89, 8B) ; CABRIOLET (8G7, B4) , 80 (8C, B4) ; 100 (4A, C4)



117	OEM	Specification
	STANDARD: AC10, AC300 OEM: 4861084	<p>CHRYSLER CIRRUS 97-95 DAYTONA 93-86 DYNASTY 90-88 LASER 86 LEBARON 95-86 NEW YORKER 90-86 SEBRING 97-96 TC MASERATI 91-89 TOWN & COUNTRY 88-86</p> <p>DODGE 600 88-86 ARIES 89-86 CARAVAN / GRAND CARAVAN 97-88 CHARGER 86 DAKOTA 96-89 DAYTONA 93-86 DYNASTY 93-88 LANCER 89-86 OMNI 90-86 SHADOW 94-87 SPIRIT 95-93,91-89 STRATUS 97-95</p> <p>PLYMOUTH ACCLAIM 95-89 CARAVELLE 88-86 EXPO 89-88 HORIZON 90-88 RELIANT 89-86 SUNDANCE 94-87 VOYAGER / GRAND VOYAGER 97-87</p>
	STANDARD: AC303 ,AC8 4300494 4307897 4467002 4861086 4612740	<p>DODGE CHERYSLER PLYMOUTH TOYOTA CRESSIDA LUXURY WAGON 4-DOOR, CRESSIDA LUXURY SEDAN</p>



119	OEM	Specification
	STANDARD: AC71 4796503, 4669480 MO4796503 AC312 21985 2171682 2H1077	<p>CHRYSLER SEBRING (95-99) DODGE AVENGER (95-99) NEON (95-97) STRATUS (96-97) EAGLE TALON (95-98) MITSUBISHI ECLIPSE (95-99) PLYMOUTH BREEZE (96-97) NEON (95-97)</p>
	SHORT CODE: B32/00 SIMENCE: A97115 PEUGEOT : 19206W HELLA : 6NW009141351	<p>PEUGEOT 106 II (1) 1.4i (96) 106 Mk II (1) 1.4i (96) 306 (7A, 7C, N3, N5) HB 1.4L(93-01) 306 (7B, N3, N5) 1.4 SL(94-01) 306 (7B, N3, N5) Saloon 1.4L(94-01) PARTNER (5) Box 1.4L(96) CITROEN SAXO (S0, S1) VTS 1.4L (96-03) ZX (N2) 1.4i(91-97) ZX Break (N2) 1.4i(93-97) ZX Estate (N2) 1.4i(93-97)</p>
120	OEM	Specification
	MAC-A059 OE: 1920.9L SIEMENS VDO:A97122 HELLA:6NW 009 141-361 MARELLI:801001301601 MAGNETI MARELLI:B32/01 MEAT & DORIA:84051	<p>CITROEN BERLINGO BOX (M_)(MBKFX)1.4 I(96) SAXO (S0, S1) HB 1.4 VTS (96) PEUGEOT 106 II (1) HB 1.4 I (96) 106 MK II (1) HB 1.4 I (96) 306 (7B, N3, N5) SALOON 1.4 SL (94-01) 306 (7A, 7C, N3, N5) HB 1.4SL (93-01) 306 SEDAN (7B, N3, N5) SALOON 1.4 SL (94-01) PARTNER BOX (5) 1.4 (96) PARTNER COMBISPACE (5F) MPV 1.4 (96) PARTNER VAN (5) BOX 1.4 (96) RANCH MPV (5F) 1.4 (96)</p>
	MAC-A059 OE: 1920.9L SIEMENS VDO:A97122 HELLA:6NW 009 141-361 MARELLI:801001301601 MAGNETI MARELLI:B32/01 MEAT & DORIA:84051	<p>CITROEN BERLINGO BOX (M_)(MBKFX)1.4 I(96) SAXO (S0, S1) HB 1.4 VTS (96) PEUGEOT 106 II (1) HB 1.4 I (96) 106 MK II (1) HB 1.4 I (96) 306 (7B, N3, N5) SALOON 1.4 SL (94-01) 306 (7A, 7C, N3, N5) HB 1.4SL (93-01) 306 SEDAN (7B, N3, N5) SALOON 1.4 SL (94-01) PARTNER BOX (5) 1.4 (96) PARTNER COMBISPACE (5F) MPV 1.4 (96) PARTNER VAN (5) BOX 1.4 (96) RANCH MPV (5F) 1.4 (96)</p>



122	OEM	Specification
	OEM: 17088118 ,17089084 17111809, 17112350, 17112351,17089084 DELCO: 217419 WELLS: AC107,AC5 WALKER: 215-1008 805224A1	BUICK CENTURY V6 2.8L (87-88) CENTURY V6 3.1L (97-05) REGAL V6 2.8L (88-89) REGAL V6 3.1L (89-96) RENDEZVOUS V6 3.4L (02-05) SKYLARKV6 3.4L (94-98) CADILLAC CIMARRON V6 2.8L (87-88) CHEVROLET CAMARO (90-92) LUMINA(91-95) MONTE CARLO (95) OLDSMOBILE CUTLASS SUPREME (91-95) PONTIAC FIREBIRD(90-92) GRAND PRIX (91-95)
123	OEM	Specification
	00016 17100016 C2177 A95228	BUICK CENTURY (87-05) CADILLAC CIMARRON (87-88) CHEVROLET BERETTA(87-96) GMC C6000 (90) OLDSMOBILE ACHIEVA(94-98) PONTIAC GRAND AM (94-05)
124	OEM	Specification
	GM:02851 A95267 17102851 93744875 17112967	BUICK D0016, C2177



125	OEM	Specification
	90140	
126	OEM	Specification
	WALKER: 215-1017 OEM: 4573367, 4861083, 4307602, 4458806, 4300495, 4458366, 4573367, 4861083AB WELLS: AC101 ,AC302, AC173,AC330	CHRYSLER 1998-95 CIRRUS, SEBRING, SEBRING CONVERTIBLE 2.5L (H) 154" PFI; 1995-90 ALL MODELS 3.0L 184" PFI; 1997-93 CONCORDE, LHS, NEW YORKER 3.3L 203" PFI; 1995-90 ALL MODELS 3.3L 203" PFI; DODGE 1998-95AVENGER, STRATUS 2.5L (H, N) 154" PFI; 1990ALL MODELS 3.0L 184" PFI; 1997-93 INTREPID3.3L 203" PFI; 1990 ALL MODELS 3.3L 203" PFI; EAGLE 1997-93 VISION 3.3L (T) 203" PFI; PLYMOUTH 1998-97 BREEZE 2.5L 154" PFI; 1990 ALL MODELS 3.0L 184" PFI; 1990 ALL MODELS 3.3L 203
127	OEM	Specification
	WALKER: 215-1017 OEM: 4573367, 4861083, 4307602, 4458806, 4300495, 4458366, 4573367, 4861083AB WELLS: AC101 ,AC302, AC173,AC330	CHRYSLER 1998-95 CIRRUS, SEBRING, SEBRING CONVERTIBLE 2.5L (H) 154" PFI; 1995-90 ALL MODELS 3.0L 184" PFI; 1997-93 CONCORDE, LHS, NEW YORKER 3.3L 203" PFI; 1995-90 ALL MODELS 3.3L 203" PFI; DODGE 1998-95AVENGER, STRATUS 2.5L (H, N) 154" PFI; 1990ALL MODELS 3.0L 184" PFI; 1997-93 INTREPID3.3L 203" PFI; 1990 ALL MODELS 3.3L 203" PFI; EAGLE 1997-93 VISION 3.3L (T) 203" PFI; PLYMOUTH 1998-97 BREEZE 2.5L 154" PFI; 1990 ALL MODELS 3.0L 184" PFI; 1990 ALL MODELS 3.3L 203



128	OEM	Specification
	<p>HOT-STAMP: B22/00, B22/01 PEUGEOT: 19204X SIMENC: A97104, A97113 HELLA: 6NW009141341</p>	<p>PEUGEOT 306 (7B, N3, N5); 406 (8B); 406BREAK (8E/F); PARTNER COMBISPACE (5F)</p>
129	OEM	Specification
	<p>WELLS: AC101 STANDARD: AC302</p>	<p>CHRYSLER CIRRUS 00-98 SEBRING 00-97 DODGE AVENGER 00-97 CARAVAN / GRAND CARAVAN 97 INTREPID 97 STRATUS 00-98 PLYMOUTH VOYAGER / GRAND VOYAGER 97</p>
130	OEM	Specification
	<p>WALKER: 215-1000 WELLS: AC305 STANDARD: AC68 OEM: 53030450, 53030657, 53009735, 53030657AB, 53030657AC AIRTEX Part: 2H1079</p>	<p>DODGE TRUCK 1998-96 B1500, B2500, DAKOTA, RAM 1500 3.9L (X) 240" PFI, 1994 ALL MODELS 3.9L 240" PFI, 1993-92 ALL MODELS 3.9L 240" PFI, 1992 ALL MODELS 3.9L 240" PFI, 1998-96 B1500, B2500, B3500, DAKOTA, RAM 1500, RAM 2500 5.2L (T, Y) 318" PFI, 1996-92 ALL MODELS 5.2L 318" PFI, 1992 ALL MODELS 5.2L 318" PFI, 1998-94 B2500, B3500, RAM 1500, RAM 2500, RAM3500 5.9L (5, Z) 363" PFI, 1996-92 ALL MODELS 5.9L 363" PFI, 1998-96 RAM 2500, RAM 3500 8.0L (W) 492" PFI, 1996-92 ALL MODELS 8.0L 492" PFI, JEEP 1996-93 CHEROKEE, COMANCHE, GRAND CHEROKEE, 5.2L 320" PFI, 1998-97 GRAND CHEROKEE 5.9L (Z) 360" PFI</p>



131	OEM	Specification
	<p>DELPHI: CV10153 53030840</p>	<p>DODGE DAKOTA(00-02) DURANGO (00-01) RAM 1500 PICKUP (02-03) JEEP GRAND CHEROKEE (99-04) LIBERTY(02-03)</p>
132	OEM	Specification
	<p>B13/00 C95181 SIEMENCE: 1920V7 ,1920-1F MARELLI: 230016079087 230016079247</p>	<p>CITROEN ZX (N2) HB 1.8L (96-97) ZX (N2) HB 2.0L (96-98) ZX (N2) ESTATE 1.8L (96-98) XANTIA (X1) HB 1.8L (95-98) XSARA (N1) HB 2.0L (97-00) XSARA COUPE (N0) 2.0L(98-05) XANTIA ESTATE (X1) SALOON 1.8L (95-98) PEUGEOT 106 I (1A, 1C) HB 1.1L (91-96) 106 I (1A, 1C) HB 1.3L 1.6L (93-96) 106 MK II (1) HB 1.6L (96) 306 CONVERTIBLE (7D, N3, N5) 1.8L (00-02) 306 CONVERTIBLE (7D, N3, N5) 2.0L (97-02) 306 WG (7E, N3, N5) ESTATE 1.8L 2.0L (97-02) 406 ESTATE (8E/F) 1.8L 16V (96-00) 406 SEDAN (8B) SALOON 1.8L (95-00)</p>
133	OEM	Specification
	<p>53007562</p>	<p>JEEP CHEROKEE GRAND CHEROKEE 4.0L INLINE 6 CYLINDER ENGINE 1992-1998.</p>



134	OEM	Specification
	A5298	
135	OEM	Specification
	<p>OEM: STANDARD: AC73T</p>	<p>Specification</p> <p>1993-1997 JEEP TRUCK All Models V8-318 5.2L 1998 JEEP TRUCK All Models V8-360 5.9L 1992-1997 DODGE TRUCK All Models V8-318 5.2L 998 DODGE TRUCK DAKOTA V8-318 5.2L 1998 DODGE TRUCK B1500 VAN V8-318 5.2L 1998 DODGE TRUCK RAM 1500 PICKUP V8-318 5.2L 1992-1993 DODGE TRUCK B 100-350 VANS V8-360 5.9L 1992-1993 DODGE TRUCK DW 100-350 PICKUPS V8-360 5.9L</p>
136	OEM	Specification
	<p>HELLA :6NW009141321 MAGNETI MARELLI :230016079197 MAGNETI MARELLI :B27/00 PEUGEOT :19205F VDO: A97108</p>	<p>CITROEN SAXO (S0, S1) HB 1.4 L(96-03) PEUGEOT 106 II (1) HB 1.4i (96) 106 Mk II (1) HB 1.4i (96) 206 (2A/C) HB 1.4i (98) 206 SW (2E/K) Estate 1.4L(02)</p>



137	OEM	Specification
	<p>CITROËN :1920N1 CITROËN: 95644484 FIAT :9564448480 HELLA: 6NW009141211 MAGNETI MARELLI :230016079057 MAGNETI MARELLI :B0401 PSA: 163552 PSA :96069888 VDO: A95269 D5131</p>	<p>PEUGEOT 405 I SALOON (15B) 1.6L (87-92) 405 I BREAK ESTATE (15E) 1.6L (88-92) 405 I ESTATE (15E) 1.6L(88-92) 309 II (3C, 3A) HB 1.6L (89-93) 309 MK II (3C, 3A) HB 1.6L (89-93) CITROEN BX (XB_) 16 E HB (89-93) BX BREAK (XB_) ESTATE 16 (89-94)</p>
138	OEM	Specification
	<p>CITROËN :1920N1 CITROËN: 95644484 FIAT :9564448480 HELLA: 6NW009141211 MAGNETI MARELLI :230016079057 MAGNETI MARELLI :B0401 PSA: 163552 PSA :96069888 VDO: A95269 D5131</p>	<p>PEUGEOT 405 I SALOON (15B) 1.6L (87-92) 405 I BREAK ESTATE (15E) 1.6L (88-92) 405 I ESTATE (15E) 1.6L(88-92) 309 II (3C, 3A) HB 1.6L (89-93) 309 MK II (3C, 3A) HB 1.6L (89-93) CITROEN BX (XB_) 16 E HB (89-93) BX BREAK (XB_) ESTATE 16 (89-94)</p>



139	OEM	Specification
	<p>D5199 D95199 10790</p>	<p>CHERY ,FENGYUN,QIYUN</p>
140	OEM	Specification
	<p>SHORT CODE: B95/00 SIMENCE: C95197, 1920X9 HOT STAMP: C5197 HELLA: 6NW009141451 9569691680</p>	<p>PEUGEOT 405 II (4B) Saloon 1.8L (92-95) 405 II Break (4E) Estate 1.8L(92-96) 405 Mk II (4B) Saloon 1.8L(92-95) 405 Mk II (4E) Estate 1.8L(92-96) 406 (8B) Saloon 2.0L (95-04) 605 (6B) Saloon 2.0L (94-99) BOXER (230P) Bus 2.0i (94-02) BOXER Flatbed / Chassis (ZCT) 2.0i(94-02)</p>
141	OEM	Specification
	<p>90200 390200</p>	



142	OEM	Specification
	<p>90380 390380 10526 510526 90325864</p>	<p>BUICK EXCELLE 1.63L CHEVROLET LOVA 1.6L LOVA 1.63L</p>
143	OEM	Specification
	<p>MAC-A022 OE:C95184 MAGNETI MARELLI:B15/00 SIEMENS VDO:95184</p>	<p>PEUGEOT, CITROEN SAXO (S0, S1) 106MK II (1)</p>
144	OEM	Specification
	<p>HOT-STAMP: B23/00 RENAULT: 7701042403 SIMENCE: D95129</p>	<p>RENAULT KANGOO (KC0_/1_) 1.2L 1.4L (97) (KC0_/1_) 1.6L (99-01) RAPID (FC0/1_) 1.2L 1.4L (97) RAPID (FC0/1_) BOX 1.2L (98-01) TWINGO (C063, C064) HB 1.2L (93-96) (C066, C068) HB 1.2L (96) (C067) HB 1.2L (96) VAN (S066, S068) BOX 1.2L (96) CLIO I HB 1.2L (90-98) CLIO I (B/C57_) (5/357Y, 5/357K) HB 1.2L (96-98) CLIO I BOX (S57_) 1.2L (91-98) CLIO IIBOX (SB0/1/2_) (SB0A) 1.1L (98) CLIO MK II (BB0/1/2_, CB0/1/2_) 1.2L (98)</p>



145	OEM	Specification
	<p>SHORT CODE:02739 OE:17102739 HELLA:6NW 009 141-241 SIEMENS VDO:A95278</p>	<p>LADA , OPEL</p>
146	OEM	Specification
	<p>19209V MAC-A058 SIEMENS VDO:A97110 HELLA:6NW 009 141-331 MAGNETI MARELLI:230016079227 MAGNETI MARELLI:B30/00 MEAT & DORIA:84049 STANDARD:14869</p>	<p>PEUGEOT 206 (2A/C, T3E) HB 1.1 I (98) SW (2E/K) ESTATE 1.1 (02) WG (2E/K) ESTATE 1.1 (02)</p>
147	OEM	Specification
	<p>OEM: 734613, 30877,C01430, P93740917 A95303 93740918</p>	<p>BUICK EXCELLE 1.6L CHERRY</p>



148	OEM	Specification
149	OEM	Specification
	<p>4637073 4626053 4698376 53008025 17119281</p>	<p>JEEP GRAND CHEROKEE 2500 WRANGER</p>
150	OEM	Specification
	<p>SHORT CODE: B06/01 SIMENCE: A95275</p>	



151	OEM	Specification
	<p>SHORT CODE:B08/01 MARELLI:40380202 VDO:AT-00801R VW:0269060491 FIAT:7076356 FORD:F5PF9N825AA</p>	<p>FIAT ELBA, UNO SPI Gas 1.5L (92/96) FIORINO SPI Gas 1.5L 1.6L (92/96) PRÉMIO SPI Gas 1.5L (92/94) TEMPRA SPI Alc 2.0L (95/96) TEMPRA MPI Gas 2.0L (95)</p> <p>FORD ESCORT AIC 1.6L 1.8L (95/96) ESCORT Gas 1.8L (95) PAMPA SPI 1.8L (95/96) ROYALE SPI 1.8L (95) VERONA SPI 1.6L (95) VERSAILLEAIC Gas 1.8L (95/96)</p> <p>VW GOL CFI AIC Gas 1.6 AP 1.8L(94/97) GOL MPI Gas 2.0L(95/96) LOGUS CFI AIC Gas 1.6 AP, 1.8 AP (94/96) PARATI MPFI Gas 2.0L (95/96)</p>
	<p>MARRLLI:230016079047 SIEMNCE:A95262 ,1920Q8 RENAULT:7701204054 CITROËN :95644634 HELLA :6NW009141201 MAGNETI MARELLI: 230016079047 MAGNETI MARELLI :B0301 9564463480</p>	<p>CITROEN AX (ZA_) HB (86-97)</p> <p>PEUGEOT 106 I (1A, 1C) HB 1.1L (91-96) 205 I (741B,20D)Convertible1.1L (89-94) CLIO I (S57_) Box 1.2L (91-98)</p> <p>RENAULT EXPRESS Box (F406, G40A)1.2L (91-98) RAPID Box (F406, G40A)1.2L (91-98)</p>



154	OEM	Specification
	<p>SHORT CODE:C1351 OPEL:817254, 17112027 SIMENCE:A95160 DELPHI:ICD 00127 VDO:AT-59524R HELLA:6NW009141121 59524 17059524</p>	<p>OPEL CORSA A HB 1.3 I(86-90) TR SALOON 1.2 I(89-93) HB 1.2I (89-93) TR SALOON 1.4 I(89-93) KADETTE SALOON 1.4 I(90-91) ESTATE CAT 1.3 I(85-91) HB CAT 1.3I (85-91) SALOON CAT 1.3I (85-91)</p> <p>VAUXHALL NOVA HB CAT 1.2I (89-93) HB CAT 1.3I (89-93)</p>
	<p>SHORT CODE: C1000</p>	<p>CHEVROLET CORSA MULTIPOINT</p>
	<p>D5185</p>	



157	OEM	Specification
	<p>SHORT CODE:10186</p>	
158	OEM	Specification
	<p>SHORT CODE: D5104 MARELLI: 40396502 FIAT: 7078983 0269980492 VDO: AT-5104R</p>	<p>FIAT PALIOEL SPI Gas 1.6L (98). PALIOCITY SPI Gas 1.6L (99) VW PARATI SAVEIRO Gas 1.0L (94/96). GOL 8V CHT EFI Gas 1.0 (94/96)</p>
159	OEM	Specification
	<p>SHORT CODE: D5104 MARELLI: 40396502 FIAT: 7078983, 0269980492 VDO: AT-5104R</p>	<p>FIAT PALIOEL SPI Gas 1.6L (98). PALIOCITY SPI Gas 1.6L (99) VW PARATI SAVEIRO Gas 1.0L (94/96). GOL 8V CHT EFI Gas 1.0 (94/96)</p>



160	OEM	Specification
	<p>7705254.A5308</p>	
161	OEM	Specification
	<p>7672966</p>	
162	OEM	Specification
		<p>USED FOR THE MOTORYCLE</p>



163	OEM	Specification
		USED FOR THE MOTORYCLE
164	OEM	Specification
		
165	OEM	Specification
	HELLA:6NW009141461 SMYMBOL:D95109 ART NO:D5109 078133455D	AUDI:SEDAN/KOMBIA4 01.95-11.2000 SEDAN/KOMBIA4 QUANTTRO 01,1995-11.2000 AUDI:SEDAN/KOMBIA6 06,1994-02,1997 SEDAN/KOMBIA6 QUATTRO 06.1994-02.1997 AUDI COUPE QUATTRO 08.1992-12.1996 CABRIOLET 06,1993-08.2000 SEDAN/KOMBI 80 07.1992-07.1995 AUDI 80,100,A4,A6 ALL 2.6LITRE VW



166	OEM	Specification
	SHORT CODE:B28/00 RENAULT:8200299241 ,7700102539 SIMENCE: C95177, D95166 8200692605 90645	OPEL VIVARO Combi; VIVARO Box RENAULT ESPACE III (JE0_)MPV2.0L(98-02) ESPACE Mk III(JE0_) MPV2.0L(98-02) LAGUNA (B56_, 556_) HB 1.8L (98-01) Estate (K56_) Estate 1.8L (98-01) Grandtour (K56_) Estate 1.8L (98-01) I (B56_, 556_) HB 1.8L (98-01) Nevada (K56_) Estate 1.8L (98-91) MEGANE I Break (KA0/1_) Estate 1.4L (99) I Grandtour (KA0/1_) Estate1.4L 1.6L (99)
167	OEM	Specification
	22917	
168	OEM	Specification
	SHORT CODE: D5184 D95184	FIAT PALIO/SIENA VWGOL-1000. TEMPRA



169	OEM	Specification
	<p>SHORT CODE: B20/01 VDO: AT-2001R MARELLI: 40415202 219244820500 FIAT: 46451794 F00099M001 SXBF01B2 SXBF03A2</p>	<p>FIAT TEMPRA (159) Saloon 1.8i.e. (90-96) TEMPRA SW (159) Estate 1.8i.e. (92-93) TIPO (160) HB 1.8i.e. (90-95)</p> <p>LANCIA DEDRA (835) Saloon 1.8i.e. (89-99) DELTA II (836) HB 1.8i.e. (93-99)</p>
170	OEM	Specification
	<p>90685 390685 H6616</p>	<p>QIRUI 0.8</p>
171	OEM	Specification
	<p>SHORT CODE: B34/00 MARELLI: 40440302 ,7079064 279980491 VDO:AT-05150R D5150 40430120 026906247</p>	<p>FIAT TEMPRA (MPI - GASOLINA) 2.0L (97-99)</p> <p>SEAT INCA (MPFI - GASOLINA) 2.0L (97-98)</p> <p>VOLKSWAGEN POLO CLASSIC (MPFI - GASOLINA) 1.8L (96) QUANTUM (MPFI -ALCOOL) 1.8 L 2.0L (96) SANTANA(MPFI - GASOLINA) 1.8L 2.0L (96) SAVEIRO (MPFI -ALCOOL) 1.8L (96) VAN (MPFI - GASOLINA) 1.6L (98) PARATI (MPFI) (ALCOOL) 1.6 L (96) (ALCOOL) 1.8 L(97) (GASOLINA) 1.6L 1.8L (96) (GASOLINA) 2.0L (96-97) GOL (MPFI) (GASOLINA) 1.6L 1.8 L 2.0 L (96) (ALCOOL) 1.6 L 1.8 L (96)</p>



172	OEM	Specification
	<p>SHORT CODE:B02/01 VDO:AT01200R ,C95128 FAIT:9945635 OEM:7766269 ,9950635</p>	<p>FIAT PALIO(178BX) HB 1.6 (96) MAREA (185) SALOON 1.6 (96) MAREA WEEKEND (185) ESTATE 1.6 (96) TEMPRA (159) SALOON 1.8 I.E. (90-96) TEMPRA SW (159) ESTATE 1.8 I.E. (92-93) TIPO (160) (160.AY) HB 1.8 I.E. (90-93) TIPO (160) (160.ED) HB 1.8 I.E. (93-95) TIPO (160) HB 1.8 I.E (90-95)</p> <p>LANCIA DEDRA (835BD, 835AD) SALOON 1.8 I.E. (89-99) DELTA II (836AE) HB 1.8 I.E. (93-99)</p>
173	OEM	Specification
	<p>SHORT CODE : B12/00 MARELLI : 21924470500 OEM : 9945035</p>	<p>FIAT PANDA(141A_) 1100 HB 1(95-03) 4x4 HB (95-04) All-wheel Drive HB (95-04) Trekking 4x41 HB (91-04) i.e Box (92-04) PALIO(178BX) HB 1.2L(98) PUNTO (188.030, .050, .130, .150, .230, .250) SEICENTO (187AXB, 187AXB1A) HB 1.1L (98) SEICENTO Van (187CXB/C) Box 1.1L (98)</p> <p>LANCIA Y (840AA, 840AF1A) HB 1.2L (96-03)</p>
174	OEM	Specification
	<p>SHORT CODE: D5103 MARELLI: 40397102 VDO: AT-05103R FIAT: 7077213 RENAULT: 7702217296</p>	<p>FIAT PREMIO SPI AIC Gas 1.5L 1.6L (94) TEMPRA SPI AIC Gas 2.0 L(94/99) UNO EFI Gas 1.6L (94/96) UNO SPI AIC Gas 1.0L 1.5L (94/00) UNO EFI AIC Gas 1.5L (94/99) DUNA SPI Gas 1.6L(95) ELBA, FIORINO SPI AIC Gas 1.5L 1.6L (94/96)</p> <p>RENAULT CLIO Gas 1.6L 1.8L (97/99) MEGANE I (BA0/1_) HB 1.8L (01) MEGANE I BREAK (KA0/1_) ESTATE 1.8L (01-03) MEGANE I CLASSIC (LA0/1_) SALOON 1.8L (01) R19 Gas EFI 1.6L (96) SCENIC I (JA0/1_) MPV 1.8L (01-03)</p>



175	OEM	Specification
	<p>MARRELLI:B35/00 MARRELLI:801001185201 PSA:1920AH</p>	<p>PEUGEOT 206 1.1 ECBO</p>
176	OEM	Specification
	<p>SHORT CODE:B35/00 MARRELLI : 801001185201 PSA:1920AH</p>	<p>PEUGEOT 206 1.1 ECBO</p>
177	OEM	Specification
	<p>97128</p>	



178	OEM	Specification
	<p>OE:1920.AQ HELLA:6NW 009 141-291 MEAT & DORIA:84053 SIEMENS VDO:A96159</p>	<p>PEUGEOT 3 06 (7B,N3,N5) 1994.06</p>
179	OEM	Specification
	<p>B29/01 B33/00 1920 8X</p>	<p>PEUGEOT 206 CC (2D) Convertible 2.0 (00) 307 (3A/C) HB 2.0 (00) 307 SW (3H) Estate 2.0 (02) 406 (8B) Saloon 2.0 (00-04) 406 Break Estate (8E/F) 2.0 (00-04) 406 Coupe (8C) 2.0 (00-04) 406 Estate (8E/F) 2.0 (00-04) 406 Saloon (8B) Saloon 2.0 (00-04) 806 (221) MPV 2.0 16V (00-02) EXPERT (224) MPV 2.0 (00)</p>
180	OEM	Specification
	<p>IB02/00</p>	<p>FIAT BRAVA, DOBLO 01/ Gas. 1.6 MAREA, PALIO 01/ Gas. 1.6 SIENA, STRAD FIRE 01/ Gas. 1.6</p>



181	OEM	Specification
	<p>SHORT CODE: IB01/00</p>	<p>FIAT PANDA(141A_) 1100 4x4 HB (95-04) All-wheel Drive HB (95-04) HB (95-03) Trekking 4x4 HB (91-04) PALIO (178BX) HB 1.2L (98) PUNTO (188.030, .050, .130, .150, .230, .250) SEICENTO (187AXB, 187AXB1A) HB.1L (98) SEICENTO Van (187CXB/C) Box 1.1L (98) LANCIA Y (840AA, 840AF1A) HB 1.2L (96-03)</p>
182	OEM	Specification
	<p>SIMENCE: A96158, A97116 PEUGEOT: 19208X HOT-STAMP: B29/01, B33/00 B31/00 B29/00 MARELLI: 230016079217</p>	<p>PEUGEOT 206 SW (2E/K); 206 CC (2D); 307 (3A/C); 307 SW (3H); 406 (8B); 406 BREAK (8E/F); 406 COUPE (8C); 806 (221); 807 (E); EXPERT (224)</p>
183	OEM	Specification
	<p>SIMENS: A96157 HELLA: 6NW009141271 MARELLI: 801001185201 Peugeot: 1920.AH SHOT CODE: B35/00</p>	<p>PEUGEOT 106 MK II (1); 206 (2A/C);206SW (2E/K); 306 HATCHBACK (7A, 7C, N3, N5) 306 (7B, N3, N5); 306 BREAK (7E, N3, N5); 307 (3A/C); PARTNER COMBISPACE(5F); PARTNER BOX (5)</p>



184	OEM	Specification
	<p>2112-1148300-02 C0973</p>	<p>LADA</p>
185	OEM	Specification
	<p>2113-1148300-01</p>	<p>LADA</p>
186	OEM	Specification
	<p>SHORT CODE : B12/00 MARELLI : 21924470500 9945035</p>	<p>FIAT PANDA(141A_) 1100 HB 1(95-03) 4x4 HB (95-04) All-wheel Drive HB (95-04) Trekking 4x4 HB (91-04) i.e Box (92-04) PALIO(178BX) HB 1.2L(98) PUNTO (188.030, .050, .130, .150, .230, .250) SEICENTO (187AXB, 187AXB1A) HB 1.1L (98) SEICENTO Van (187CXB/C) Box 1.1L (98) LANCIA Y (840AA, 840AF1A) HB 1.2L (96-03)</p>



187	OEM	Specification
	<p>A6051 ,F1294A 94503584</p>	<p>MOTOROLA SYSTEM ZHANQI</p>
188	OEM	Specification
		<p>A1554P 83005</p>
189	OEM	Specification
		



190	OEM	Specification
	<p>7672966</p>	
191	OEM	Specification
		
192	OEM	Specification
		



193	OEM	Specification
		<p>IDLE MOTORS FOR THE CNG KITS</p>
194	OEM	Specification
		<p>IDLE MOTOR FOR THE CNG KITS</p>
195	OEM	Specification
		<p>IDLE MOTOR FOR THE CNG KITS</p>



196	OEM	Specification
	<p>R008/2243</p>	<p>IDLE MOTORS FOR THE CNG KITS</p>
197	OEM	Specification
	<p>R008/2243</p>	<p>IDLE MOTORS FOR THE CNG KITS</p>
198	OEM	Specification
		<p>IDLE MOTORS FOR THE CNG KITS</p>



IDLER AIR CONTROL VALVE





199	OEM	Specification
	0280140577 0280140548 3284010235 90469595 90512528 026133361 826549 826551	OPEL OMEGA B ESTATE 2.0L (94-99) SINTRA MPV 2.2L (96-99) VECTRA B ESTATE (31_) 2.5L(96-00) HB (38_) 2.5L(99-00) FRONTERA A (54MWL4) CLOSED OFF-ROAD VEHICLE 2.2L(95-98) OPEN OFF-ROAD VEHICLE 2.2L(95-98) VAUXHALL FRONTERA OPEN OFF-ROAD VEHICLE2.0L 2.2L (95-98) SPORT OPEN OFF-ROAD VEHICLE2.0L(92-98) OMEGA ESTATE 2.0L(94-99) GM GOL SANTANA 1.6L/1.8L
200	OEM	Specification
	3284010236 0280140578 3515033001 3515033010 OK9A2-20-660A 0280140571 7789627 60811197 280140553	ALFA ROMEO 145 (930) T.S. HB 2.0L (95-01) 146 (930) T.S. HB 2.0L (95-01) 155 (167) T.S. Saloon 1.7L 1.6L(96-97) 155 (167.A2G) T.S. Saloon 2.0L (95-97) GTV SPARK coupe (916.C2) 2.0L (95) SPIDER (916S_)Convertible T.SPARK 2.0L(95-05) FIAT BRAVO (182.AD) HGT HB 2.0L (95-98) KIA MENTOR (FA) HB 1.8 i (95) MENTOR Saloon (FA) 1.8 I (95) LANCIA KAPPA(838A) Saloon 2.0L (94-01) KAPPA(838AC1AA) Saloon 2.4L (94-01) HYUNDAI
201	OEM	Specification
	837102 GM 90411546 VDO : X-10-739-002-001 HELLA : 6NW 009 141-001 SIEMENS: 5WK90631X AESP20713A	OPEL ASTRA F ESTATE 1.8L (93-98) CALIBRA A COUPE 4X4 2.0L (94-97) OMEGA B ESTATE 2.0L (94-99) B SALOON 2.0L (94-99) VECTRA A 2000/GT CAT SALOON (90-95) CAT SALOON 2.0L (88-95) HB 2.0 L (88-90) HB CAT 2.0L (88-95) HB GT 2.0L (88-95) SALOON 2.0L (88-90) VAUXHALL CALIBRACOUPE 2.0L (90-97)

IDLER AIR CONTROL VALVE



202	OEM	Specification
	E7TE9F715F1A E7TZ9F715A E9TE9F715BA E9TZ9F715B E7TE-9F715- FA	MAZDA NAVAJO (91-94) PICKUP (94) FORD E SERIES FULLSIZE VAN (87-93) EXPLORER/SPORT/SPORT TRAC (91-94)
203	OEM	Specification
	1S7G 9F715 AE	FORD MONDEO III (B5Y)1996/09 - 2000/11 MONDEO III (B5Y) 1.8 16VCHBA HATCHBACK MONDEO III (B5Y) 2.0 16V CJBA HATCHBACK MONDEO III ESTATE(BWY)2000/11 -/ MONDEO III ESTATE (BWY) 1.8 16VCGBAESTATE MONDEO III ESTATE (BWY) 2.0 16VCJBA ESTATE MONDEO III SALOON (B4Y)2000/11 -/ MONDEO III SALOON (B4Y) 1.8 16VCHBA SALOON MONDEO III SALOON (B4Y) 2.0 16V CJBASALOON
204	OEM	Specification
	E9T16173	MITSUBISHI HONGQI CENTURY STAR

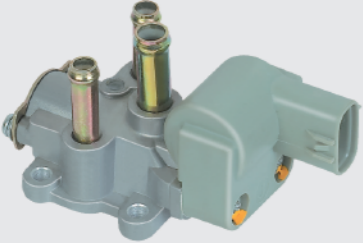
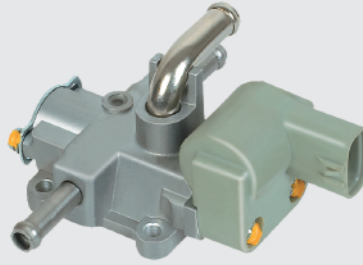

205	OEM	Specification
	22270-16060	TOYOTA
206	OEM	Specification
	22270-62050	TOYOTA
207	OEM	Specification
	22270-75030	TOYOTA



208	OEM	Specification
	22270-06020	TOYOTA
209	OEM	Specification
	18117-78F11	TOYOTA
210	OEM	Specification
	18117-76A31	TOYOTA



211	OEM	Specification
	22270-11020	TOYOTA
212	OEM	Specification
	22270-11010	TOYOTA
213	OEM	Specification
	16022P2EA51 16022-P6F-K51	HONDA



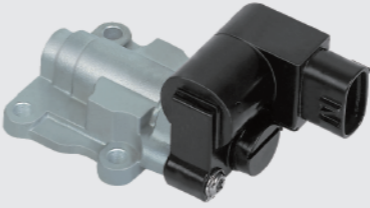
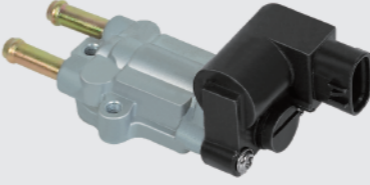
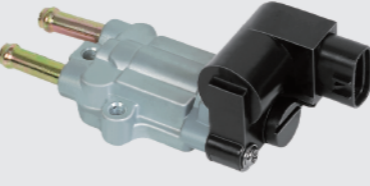

214	OEM	Specification
	22270-0D030	TOYOTA
215	OEM	Specification
	22270-0D020	TOYOTA
216	OEM	Specification
		



217	OEM	Specification
	35150-22610 35150-22600 954093005	HYUNDAI (2.8 /2.0 /1.8/ 1.6) ELANTRA, SONATA NF, KIA QIANLIMA
218	OEM	Specification
	35150-02600 9540930004	HYUNDAI ATOS MANUAL 2000 ONWARDS G4HC41.1L
219	OEM	Specification
	22270-28010	TOYOTA

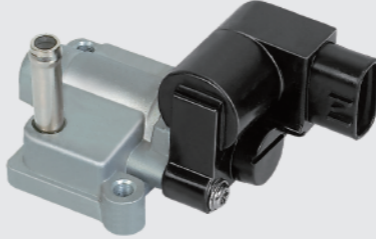

220	OEM	Specification
	16022-P8A-A02	HONDA
221	OEM	Specification
	MD628318 1450A069 MD628166	CHRYSLER SEBRING (02) DODGE STRATUS (04-01) MITSUBISHI ECLIPSE (05-00) GALANT (03-99) LANCER (06)
222	OEM	Specification
		MITSUBISHI



223	OEM	Specification
	MD619948	MITSUBISHI
224	OEM	Specification
	MD619857	MITSUBISHI
225	OEM	Specification
	MD628174 MD628117 MD628119	MITSUBISHI ECLIPSE(04-00) GALANT(03-99) OUTLANDER(03) MONTERO(04-02) MONTERO SPORT(04-99) CHRYSLER SEBRING(05-01) DODGE STRATUS(05-01)





226	OEM	Specification
		MITSUBISHI
227	OEM	Specification
	1450A132 1450A166 MD628168	MISTUBISHI LIONCEL LANCER
228	OEM	Specification
		MITSUBISHI



229	OEM	Specification
	MD628168 MD619932	MISTUBISHI GALANT LANCER OUTLANDER
230	OEM	Specification
	1450-A096	MITSUBISHI
231	OEM	Specification
		MITSUBISHI



232	OEM	Specification
		MITSUBISHI
233	OEM	Specification
		MITSUBISHI
234	OEM	Specification
	MD614918	MITSUBISHI FREECA V31



235	OEM	Specification
	E9T15373C MD614751 MD615751 MD628059	MITSUBISHI DIAMANTE(97-04) MONTERO (94-01) MONTERO SPORT (97-03)
236	OEM	Specification
	E9T16171	NISSAN
237	OEM	Specification
	MD628053 3510333030 3510433140 3510435300 3510435305 E9T15271A MD614282 MD614380 MD614381 MD614431 MD614436	DODGE RAIDER (89) RAM 50 (90-91) SPIRIT(92-93) STEALTH(91-96) HYUNDAI SONATA (94-98) MITSUBISHI 3000GT (91-99) DIAMANTE(92-96) MIGHTY MAX (90-94) MONTERO (89-94)



238	OEM	Specification
	20327 61296	BYD F3 F3R L3 G3 473QE 465QA
239	OEM	Specification
	F01R065901 390120 90120	BRILLIANCE JINBEI JINBEI GRACE 2.4
240	OEM	Specification
	32385 34613 734613	



241	OEM	Specification
	53920	WULING MACRO LIGHT
242	OEM	Specification
	04874373 4874373AB 53030821 4874373	DODGE DAKOTA (99-02) JEEP CHEROKEE (98-01) GRAND CHEROKEE (98-04) TJ (98-04) WRANGLER (98-04)
243	OEM	Specification
	04591611AA	JEEP WRANGLER 4 C. 2.4L (03-04)



244	OEM	Specification
	A95140 0009942898 0009943223 0009949146 9943223 9949146 9942898 00600	LANCIA FIAT JINBEI HIACE BRILLIANCE JINBEI CHERY
245	OEM	Specification
	11125	LANCER GEELY CK ZOTYE 2008 JAC
246	OEM	Specification
	MDQ100040 MLZ100090 SBZ008 MLZ100050	ROVER 200 400 MGF MG TF MINI LAND ROVER FREELANDER

IDLER AIR CONTROL VALVE



247	OEM	Specification
	89690-97202 41559MD	TOYOTA AVANZA RUSH F601 F65# F700
248	OEM	Specification
		LADA
249	OEM	Specification
	60304 90685	BYD F3 473QE JINBEI SIX GENERATIONS V19

IDLER AIR CONTROL VALVE





250	OEM	Specification
	8200692605A 7700100946	DACIA LOGAN MCV (KS_) 1.6 16V
251	OEM	Specification
	ERR5199 ETC6660 217437 1711286 17079256 17111286 17111288 ISC17 17111289 17111460 17111461 22048226 25527077 8171114600 8255270770	BUICK CENTURYSEDAN / COUPE (87-83) ELECTRA SEDAN / COUPE (87-86) CADILLAC FLEETWOOD (93-90) BROUGHAM (93-90) CHEVROLET ASTRO (94-85) CAVALIER(86-83) GM SILVERADO 5.7L 6.5L (92) GMC CABALLERO (87-85) ISUZU PICKUP (94-91) OLDSMOBILE BRAVADA (92-91) PONTIAC FIERO (88-85) FIREBIRD(92-85)
252	OEM	Specification
		MITSUBISHI



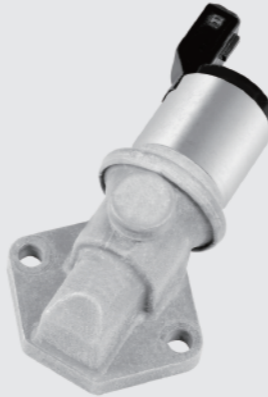

253	OEM	Specification
		MITSUBISHI
254	OEM	Specification
		MITSUBISHI
255	OEM	Specification
	1F2220660 1L5E9F715AB 1L5Z9F715AA 2L5Z9F715BA 5L5E9F715AA 5L5Z9F715A	MAZDA PICKUP (01-09) FORD RANGER (01-09) EXPLORER/SPORT/SPORT TRAC (00-04)



256	OEM	Specification
	1014398 1063996 7084580 95BF9F715AB 95BF9F715AC 95XF9F715AA	FORD ESCORT III (GAA) HB 1.3 (80-85) III BREAK (AWA) ESTATE 1.3 (81-85) III CONVERTIBLE (ALD) 1.3 (83-85) III ESTATE (AWA) 1.3 (81-85) VII (GAL, AAL, ABL) 4X4 HB 1.6 (95-98) VII (GAL, AAL, ABL) HB 1.8 (95-98) FIESTA I (GFBT) HB 1.3 (77-83) II (FBD) HB 1.3 (83-87) III (GFJ) HB 1.6 I (94-95) III (GFJ) HB 1.8 (92-95) III (GFJ) HB XR2I 1.8 (92-95) SCORPIO II (GFR, GGR) SALOON 2.0 I (94-98)
257	OEM	Specification
	96TF9F715AB 96TZ9F715AB F5OE9F715AA F5OE9F715AB F5OZ9F715AB F5TZ9F715B F67E9F715AA F67Z9F715AC XL2Z9F715BA ZZM820660 ZZMB20660	FORD EXPLORER (98-00) SPORT (98-00) SPORT TRAC (98-00) MAZDA PICKUP (97-00)
258	OEM	Specification
	F6AE9F715EA F6AZ9F715EA F6AZ9F715EB	FORD CROWN VICTORIA (97-96) MUSTANG (98-96) THUNDERBIRD (97-96) LINCOLN TOWN CAR (97-96) MERCURY COUGAR (97-96) GRAND MARQUIS (97-96)

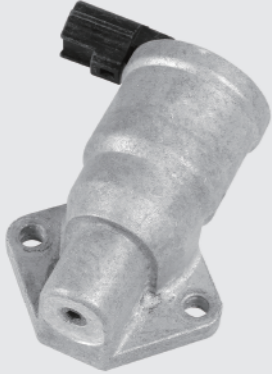
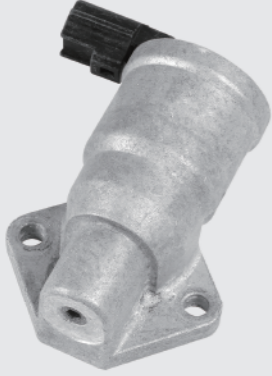

259	OEM	Specification
	XL3E9F715BA XL3F9F715BA XL3Z9F715BA	FORD E SERIES FULLSIZE VAN (99-00) F PICKUP (99-01)
260	OEM	Specification
	9F5E9F715FA F65E9F715DA F65Z9F715FA F65Z9F715FB	FORD MUSTANG (96-98) THUNDERBIRD (96-97)
261	OEM	Specification
	978F9F715AB F7RZ9F715AB XS6Z9F715AA	FORD CONTOUR (97-00) ESCORT (98-03) FOCUS (00) ZX2 (98-03) MERCURY COUGAR (99-02) MYSTIQUE (97-00)



262	OEM	Specification
	E59E9F715AC E69Z9F715A E6AE9F715C1A E6AE9F715C1B E6AZ9F715C E6ZZ9F715C E9AE9F715A1A E9AE9F715A2A E9AE9F715AA E9AZ9F715A F0AE9F715A1A F0AE9F715A2A F0DE9F715AA F0DZ9F715A F2LE9F715A1D	FORD BRONCO (86-89) BRONCO II (88-90) COUNTRY SQUIRE (87-91) RANGER (88-92) TAURUS (86-95) TEMPO (87-91) LINCOLN CONTINENTAL(88) TOWN CAR (89-90) MERCURY COUGAR (88) GRAND MARQUIS (86-91) LYNX(86-87) SABLE (86-88)



Industry/Equipment

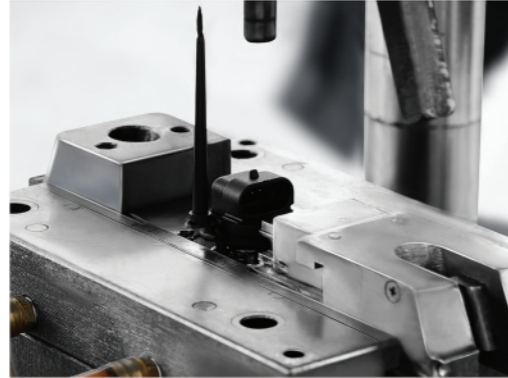

High-Precision mould

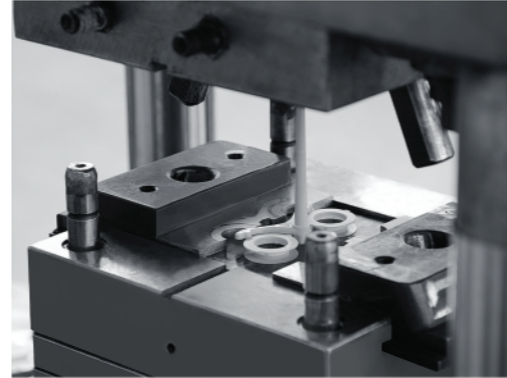

High-Precision mould

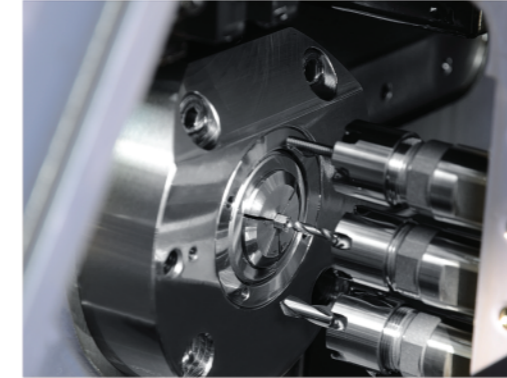

High-Precision CNC Lathe



High-Precision CNC Lathe

Componet Name

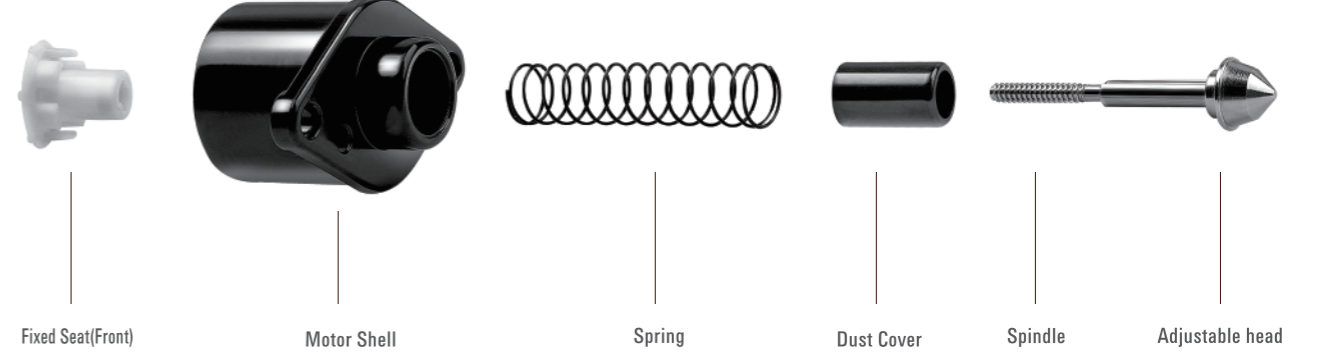
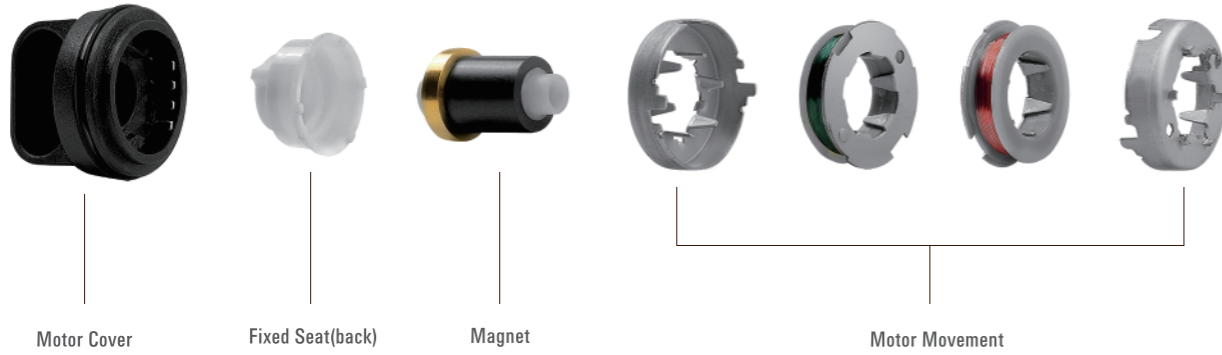

Numerically Controlled Lathe



Automatic winding machine



Laser Engraving

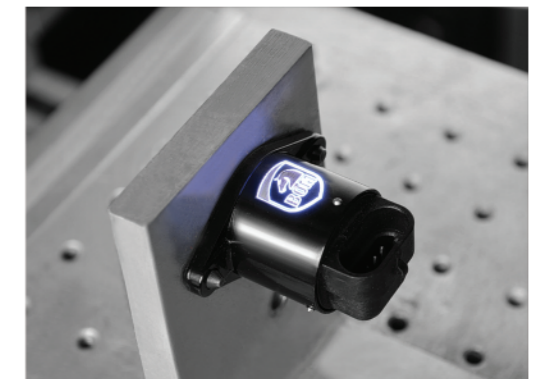

Laser Engraving

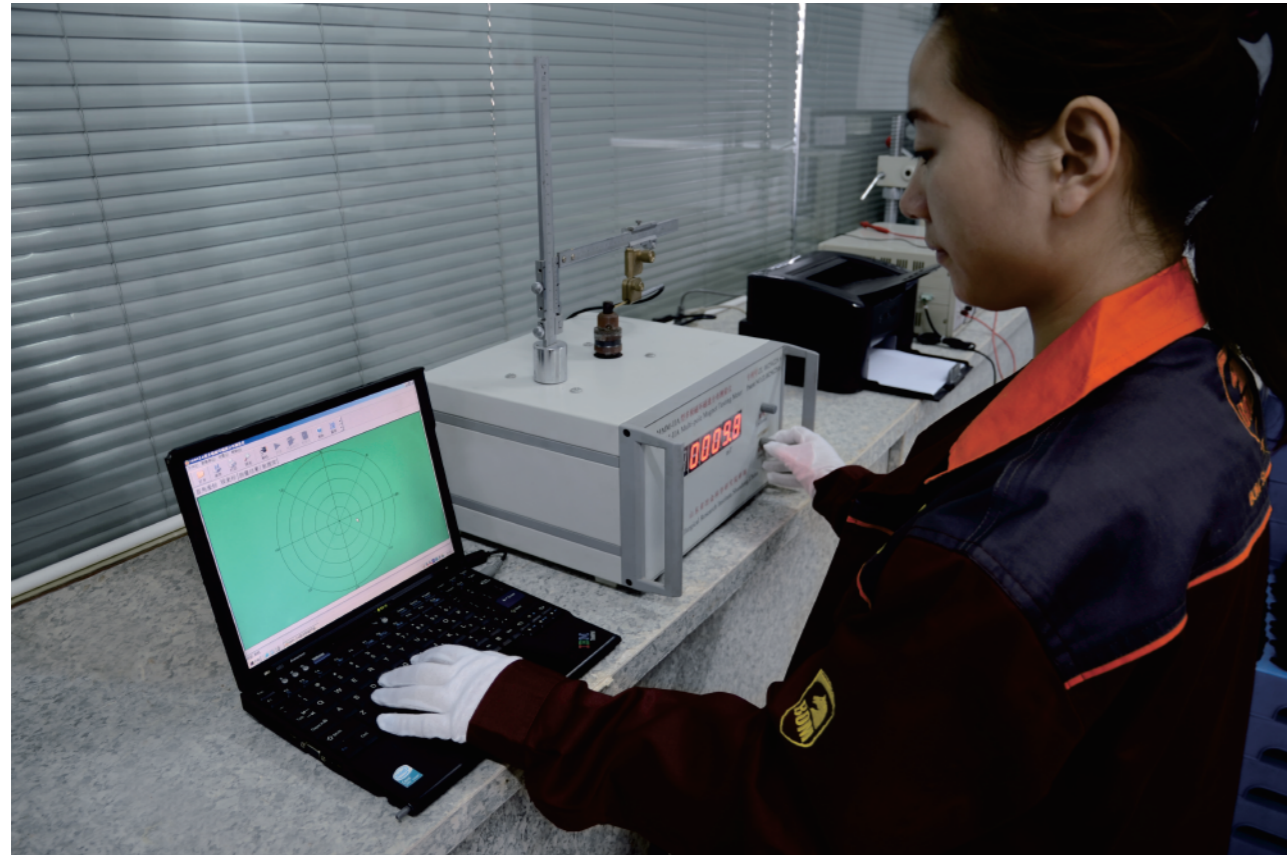

Structure and Working Principle

Magnet Field Measuring Instrument

The most simple structure of permanent magnet step motor as follows:

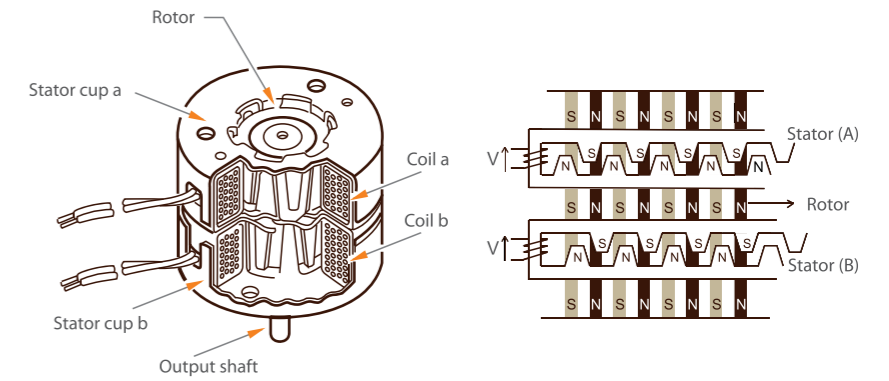
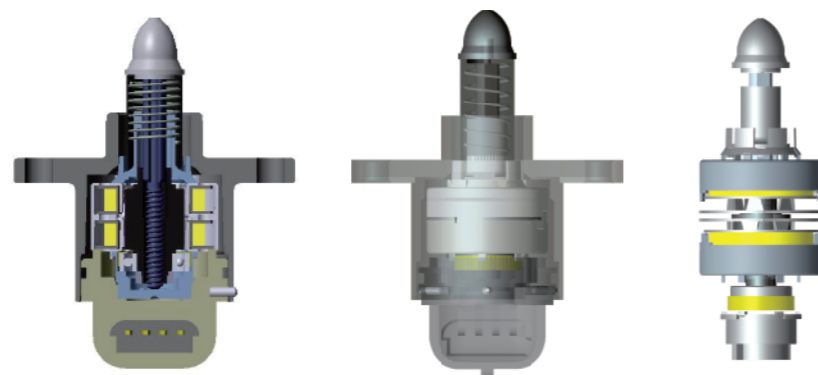

6 pairs of magnet, producing 15° stride increment ($90^\circ / 6 = 15^\circ$)

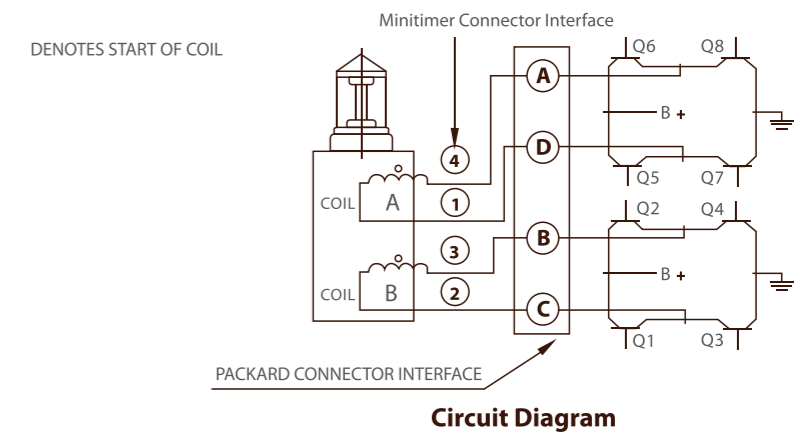

STEP	Q6-Q7	Q5-Q8	Q1-Q4	Q2-Q3
1	ON	OFF	ON	OFF
2	ON	OFF	OFF	ON
3	OFF	ON	OFF	ON
4	OFF	ON	ON	OFF
1	ON	OFF	ON	OFF

STEP	A	D	C	B
1	+	-	+	-
2	+	-	-	+
3	-	+	-	+
4	-	+	+	-
1	+	-	+	-

MOTOR ACTUATION TABLE NORMAL 4 STEP SEQUENCE



Testing Capability

Image Measuring Instrument

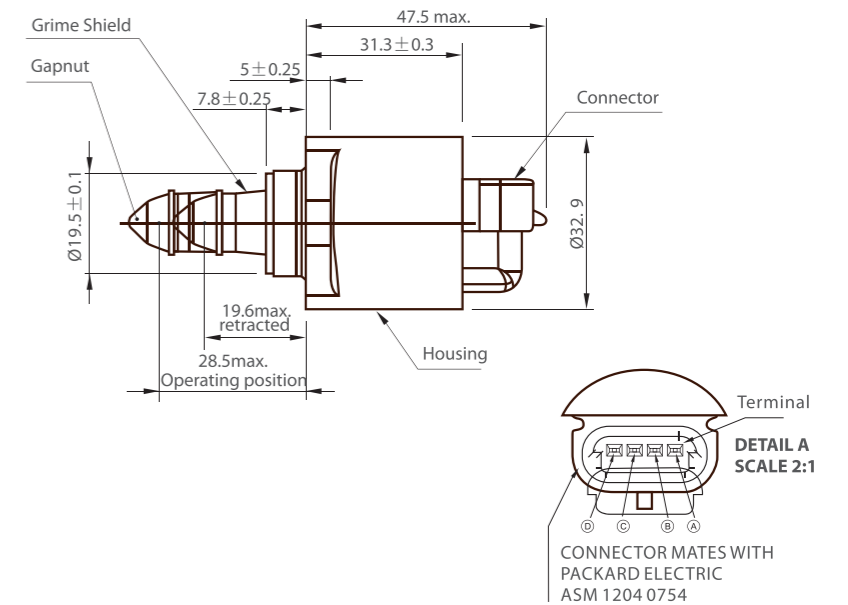
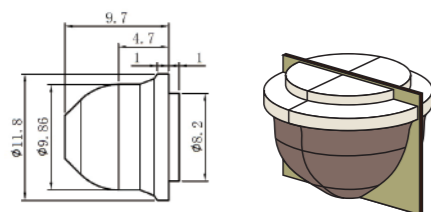
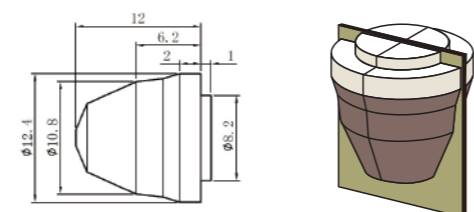
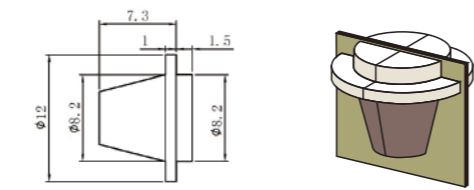
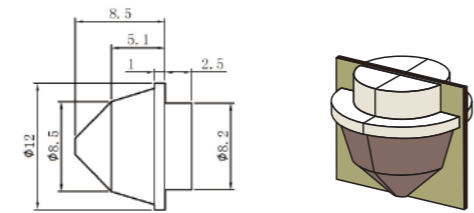
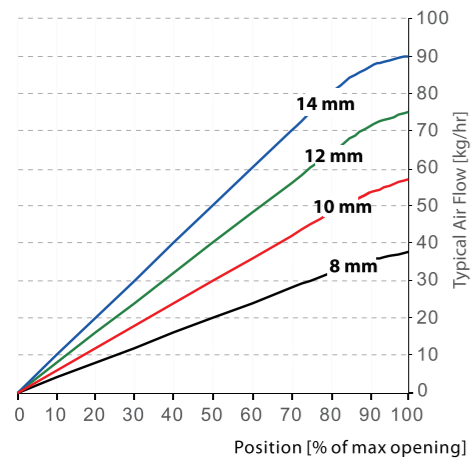

Characteristic Parameters

ITEMS	VALUE
Resistance (each coil)	51Ω ±10% (at 25°C)
Inductancy	38 mH ±15% (at 25°C)
Phase current	180 mA
Pins insulation resistance	>100 MΩ
Step increase	0.042 mm
Force at RL 12V, 180mA, 200pps, 20°C	35N mini
Protection Grade	IP65
Working voltage	5 -12 V (14.5V max during 2min)
Working temperature	-40°C - +130°C (150°C max during 2min)



Testing Capability

Vibration Tester

Vibration Durability Test

Before vibration durability test, thermal shock has to be done.
 The actuator shall be fully extended into the seat at the start of the test.
 The actuator shall be concurrently step cycled 1.08×10^6 steps per hour, and cycled in this test per table 1.
 Approximate number of steps is 2.6×10^7 per plane of vibration. The pintle is stepped into the seat an approximate total of 1.4×10^5 steps per plane of vibration.
 Operating voltage: 12 VDC.
 Stepping frequency: 300 step/s.
 Movement mode of DLA during vibration durability test: accord with table 1 and figure 2.
 Vibration direction refers to figure 3.
 Duration: 24 hours per direction, total 72 hours for three directions.
 Vibration profile: Accord with figure 4.



Table 1: Movement mode of DLA during vibration durability

Cycle Schedule			
Direction	Numbers of Steps	Repetition	Total Steps
Retract	50	1	50
Extend-Retract	25	10	500
Retract	50	1	50
Extend-Retract	25	10	500
Retract	50	1	50
Extend-Retract	25	10	500
Extend	160	1	160
Repeat as necessary			
Total step cycle			
step on seat/cycle			

Figure 2 Move mode figure of DLA during vibration durability test and life cycling test

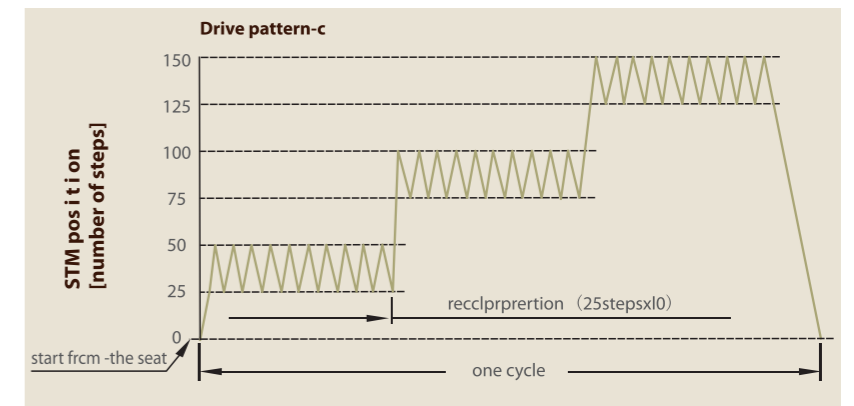

Figure 3: Vibration direction of DLA

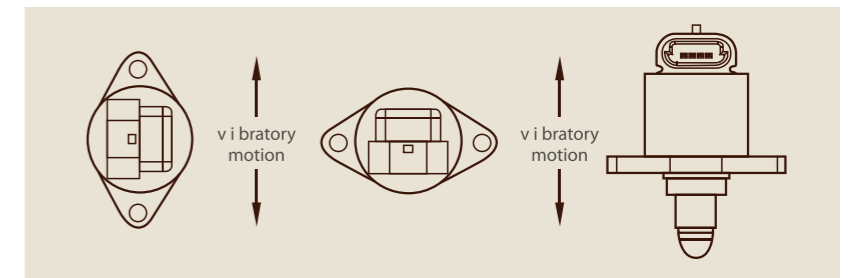
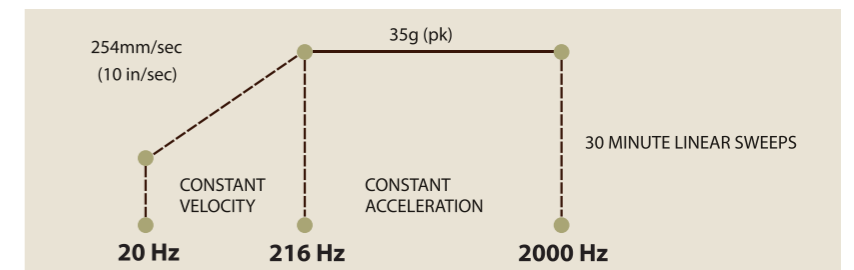

Figure 4: Vibration profile during vibration durability test





Installation Advice

Throttle Valve assembly tester

Bypass Design

Rapid bypass airflow should position control by actuator shaft which is relative to foundation bed (see chart). So the minimum flow section of whole bypass channel must format of the flow section by shaft and foundation bed

From practice, it is suggested that input and output section of bypass channel should be at least 50% greater than foundation bed

Should try to avoid as follows:

- Acute angle
- Airflow direction change sharply
- Airflow direction multiple changes (elbow pipe)
- Surface polishing rough and burr



Throttle Body Suppliers - Use Advice

Airflow direction:
Airflow must be toward the direction of arrow (as follows)

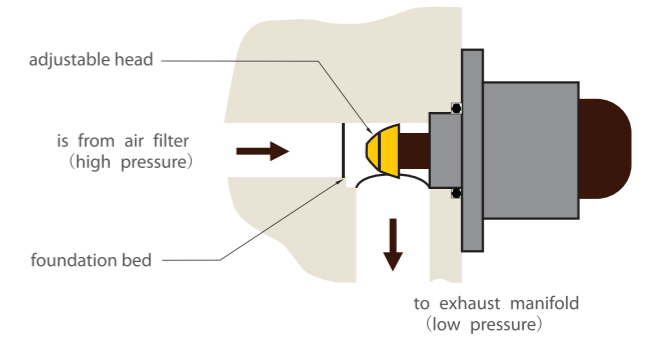

Installation Requirement

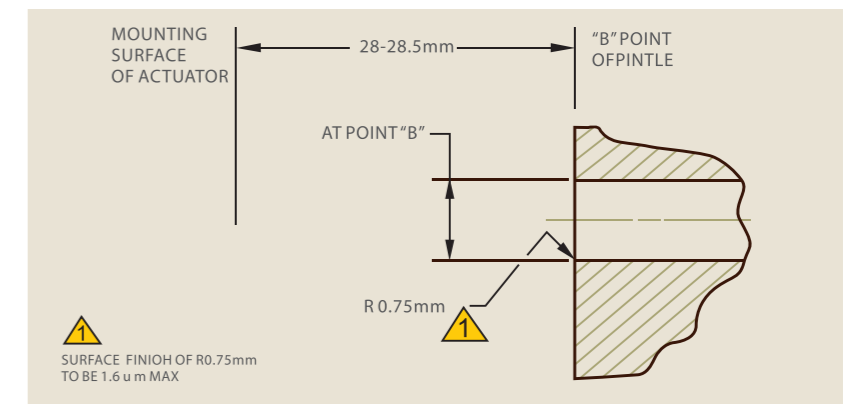

Installation Position

Actuator shaft should be level or below the level to assure condensate don't accumulate inside of actuator housing

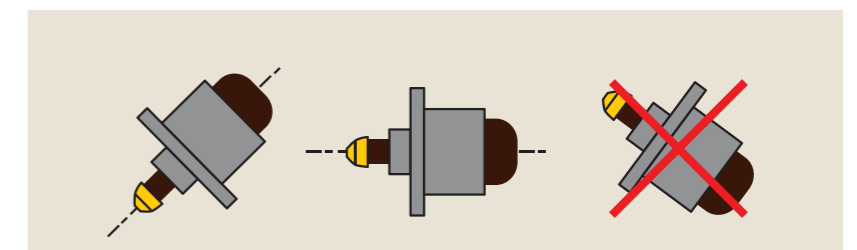

Socket Location

Outlet of actuator socket's rank direction should avoid water accumulation getting into the socket

